

Hold
57

Bane
1

René Jensen

Horsens-Hammer Skf.

ÅK2

Jyllandsstævne 2011 - riffel

Aalborg Skyttekreds

Prøveskud

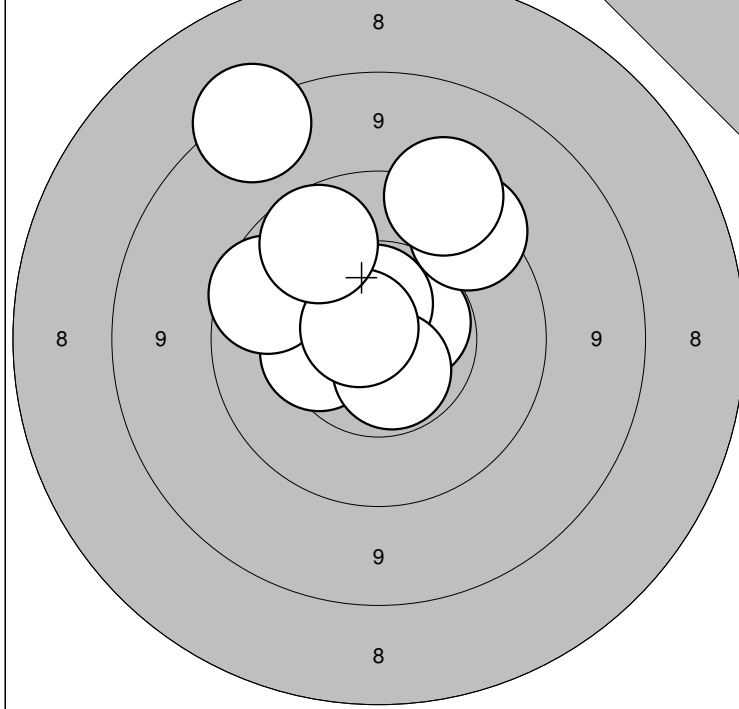

Prøveskud

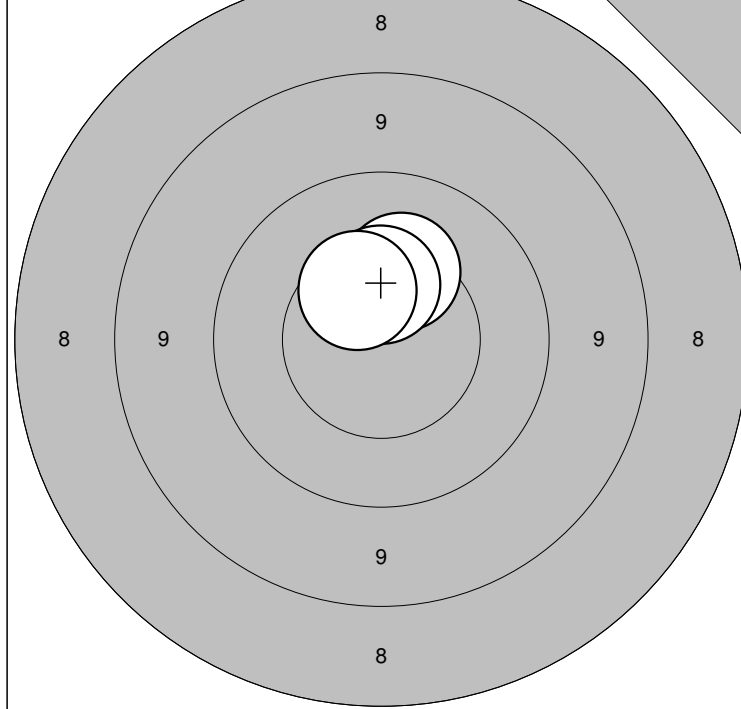

1:10,6*	➔	6: 9,9	➤
2:10,6*	⬆	7: 8,5	➔
3:10,4	➤	8:10,8*	➤
4:10,6*	➤	9: 9,5	⬆
5: 9,6	➔	10: 9,9	⬆

Serie: 94,0
Sum: 0,0

11:10,3	⬆
12:10,4	⬆
13:10,5	➤

Serie: 30,0
Sum: 0,0

Gældende

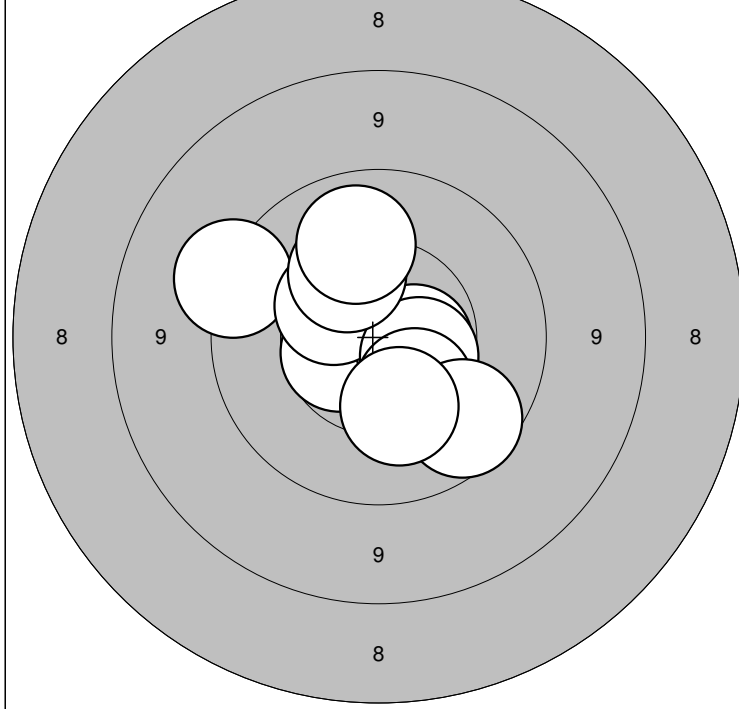

Gældende

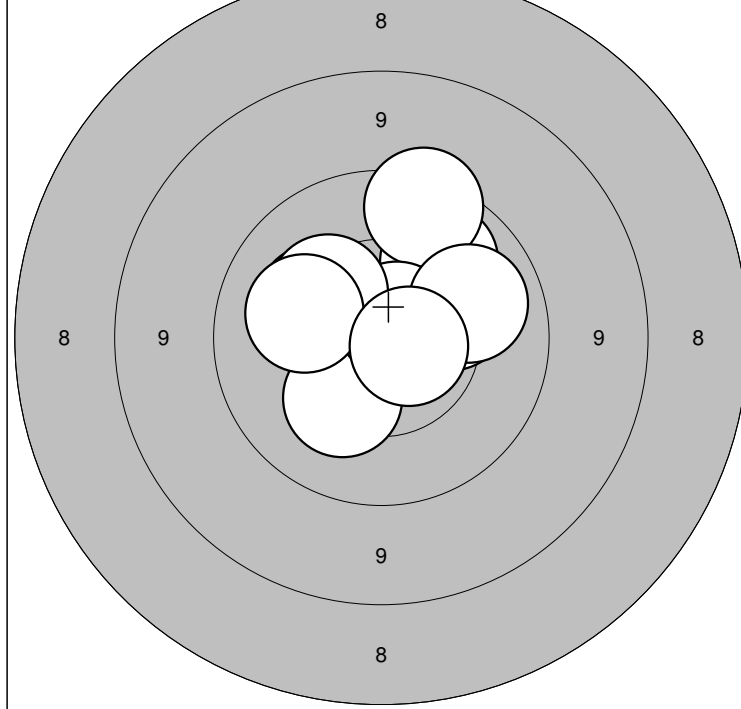

1:10,6	➤	6:10,3	⬆
2: 9,5	➤	7:10,4	➤
3:10,6*	➔	8: 9,9	➤
4:10,5	⬆	9:10,1	⬆
5:10,5	➤	10:10,3	➤

Serie: 98,0
Sum: 98,0

11:10,3	➤	16:10,7*	⬆
12:10,1	⬆	17:10,3	➤
13:10,3	➔	18:10,2	➤
14:10,3	➤	19:10,1	➔
15: 9,7	⬆	20:10,7*	➔

Serie: 99,0
Sum: 197,0

Hold

57

Bane

2

Jes Højen Olsen

Aalborg Skyttekreds

1

Jyllandsstævne 2011 - riffel

Aalborg Skyttekreds

Prøveskud

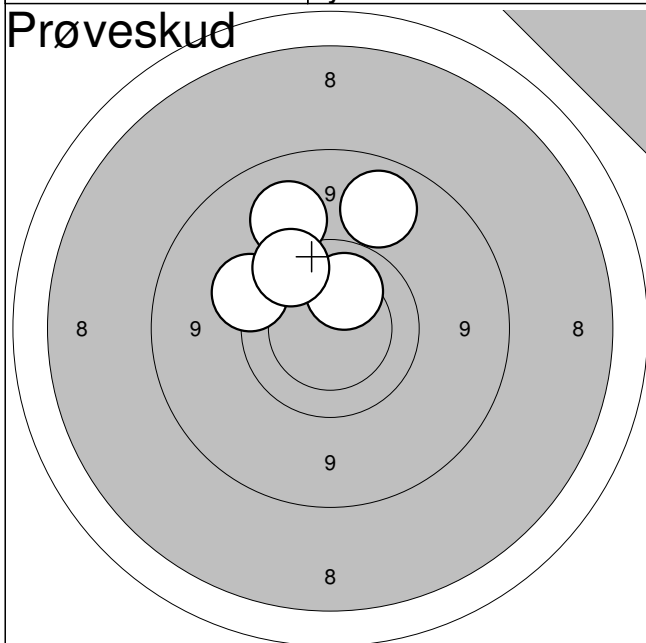

1: 9,1
 2: 9,2
 3: 9,5
 4: 10,2
 5: 9,7

↗
 ↗
 ↖
 ↗
 ↗

Serie: 46,0

Sum: 0,0

Gældende

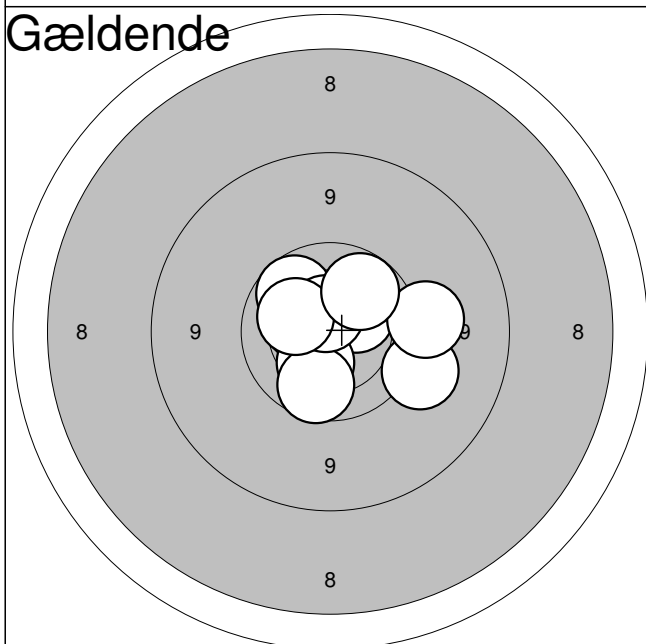

1: 9,4
 2: 10,4
 3: 10,3
 4: 9,9
 5: 10,3
 6: 9,4
 7: 9,9
 8: 10,6*
 9: 10,2
 10: 10,0

→
 ←
 ↗
 ↗
 ↓
 →
 ↓
 ↓
 ↖
 ↖
 ↗

Serie: 96,0

Sum: 96,0

Gældende

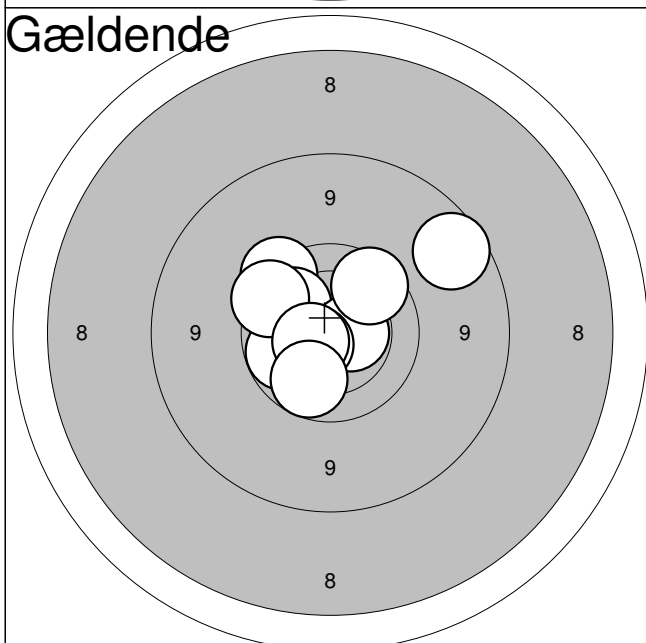

11: 9,7
 12: 10,1
 13: 10,5*
 14: 9,8
 15: 10,6*
 16: 10,0
 17: 9,8
 18: 8,9
 19: 10,5*
 20: 9,9

↗
 ↗
 →
 ↗
 ↖
 ←
 ←
 ↖
 ↗
 ↖
 ↖
 ↓

Serie: 94,0

Sum: 190,0

Jyllandsstævne 2011

Hold

57

Bane

3

Stefan Olsen

Aalborg Skyttekreds

UNG

Jyllandsstævne 2011 - riffel

Aalborg Skyttekreds

Prøveskud

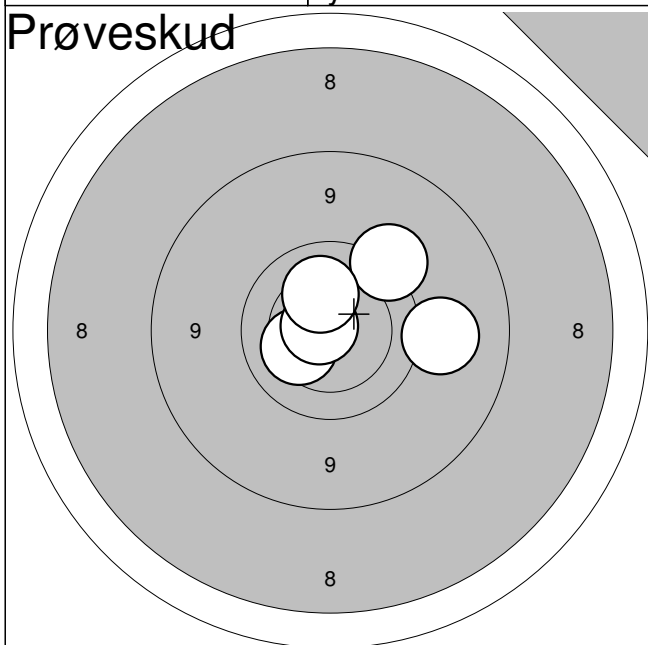

1:	9,3	→
2:	9,5	↗
3:	10,3	↖
4:	10,7*	↖
5:	10,2	↑

Serie: 48,0

Sum: 0,0

Gældende

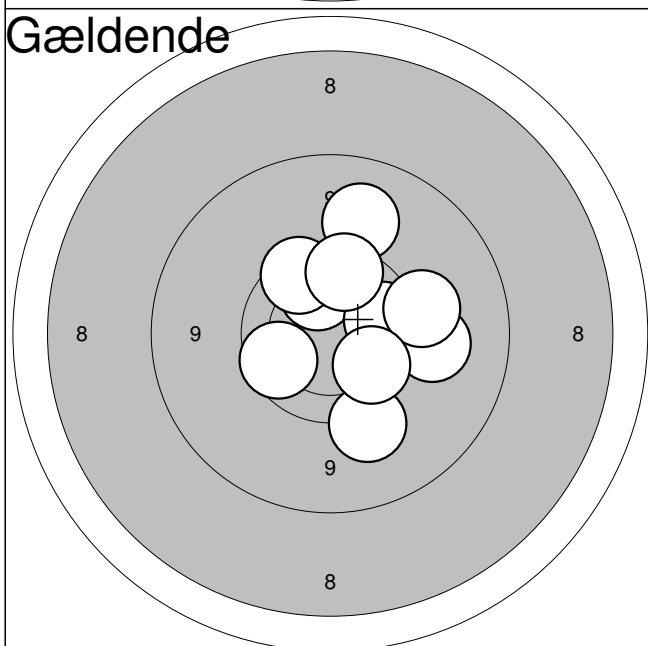

1:	9,2	↑
2:	10,1	↑
3:	9,9	→
4:	9,4	→
5:	9,9	↖
6:	9,8	↗
7:	9,4	↓
8:	9,8	↑
9:	9,5	→
10:	9,9	↘

Serie: 91,0

Sum: 91,0

Gældende

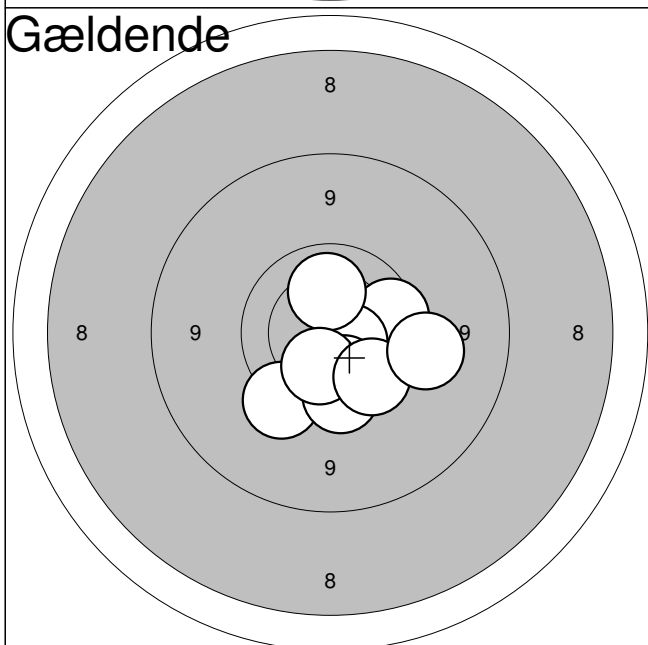

11:	9,8	→
12:	10,3	↓
13:	10,5*	↘
14:	9,6	↖
15:	10,1	↓
16:	9,8	↓
17:	10,1	↑
18:	10,3	↓
19:	9,8	↓
20:	9,4	→

Serie: 95,0

Sum: 186,0

Jyllandsstævne 2011

Hold

57

Bane

5

Niels H. Overgaard

Skytteklubben DSB/ASF

UNG

Jyllandsstævne 2011 - riffel

Aalborg Skyttekreds

Prøveskud

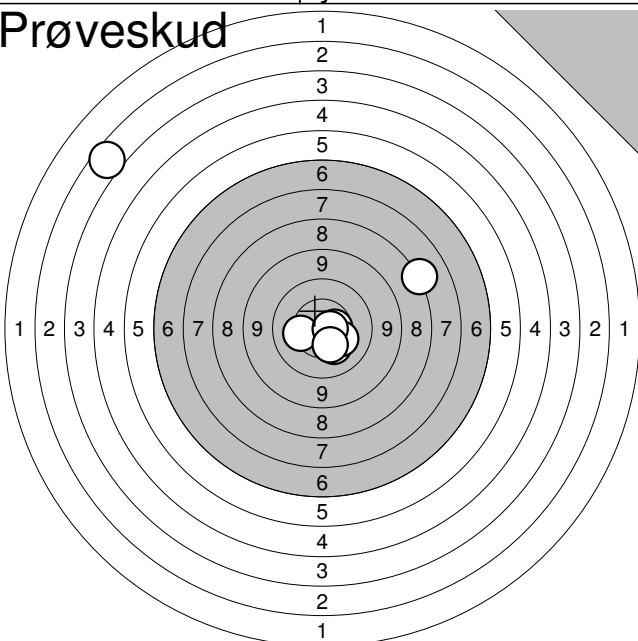

1:	1,9	↗
2:	7,3	→
3:	10,5	↘
4:	10,5	→
5:	10,3	↘
6:	10,3	←
7:	10,3	↘
8:	10,7*	→
9:	10,4	↘

Serie: 78,0

Sum: 0,0

Gældende

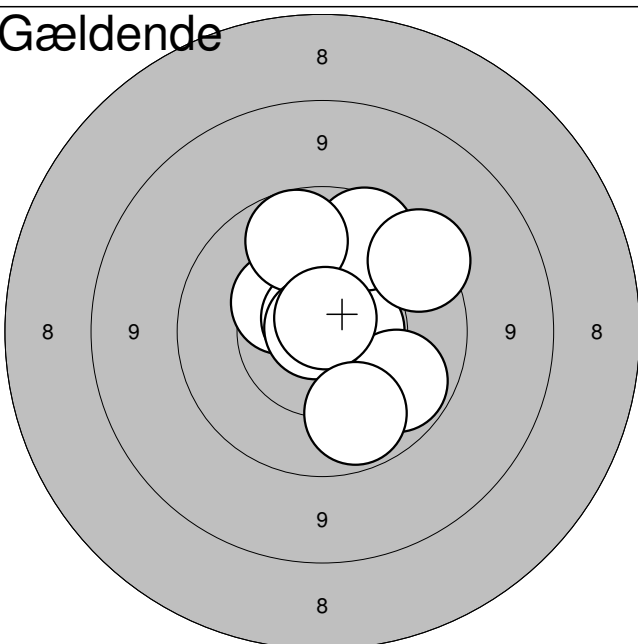

1:	10,6*	→
2:	10,4	↗
3:	10,0	↘
4:	9,9	↗
5:	10,8*	↗
6:	10,0	↗
7:	10,9*	↖
8:	9,6	↗
9:	10,8*	↗
10:	10,0	↘

Serie: 98,0

Sum: 98,0

Gældende

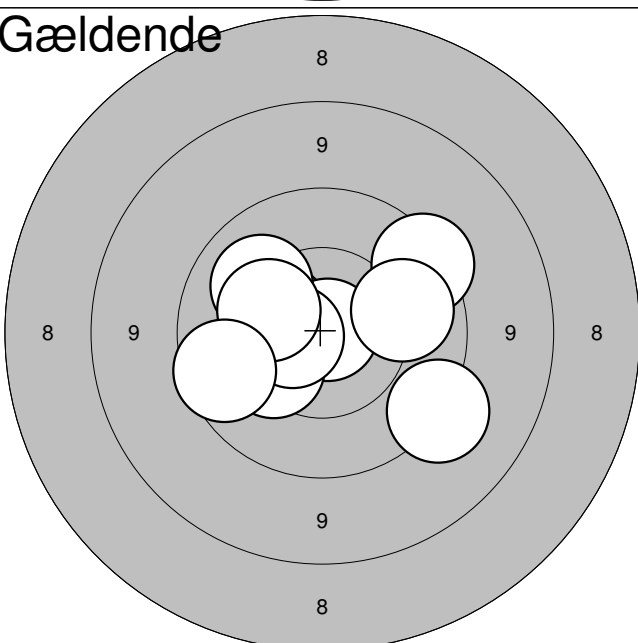

11:	9,6	↗
12:	10,4	↖
13:	10,9*	→
14:	10,1	↗
15:	10,3	↘
16:	10,1	→
17:	10,6*	←
18:	10,3	↖
19:	9,8	←
20:	9,4	↘

Serie: 97,0

Sum: 195,0

Jyllandsstævne 2011

Hold
57

Bane
6

Kristinna Olsen

Aalborg Skyttekreds

UNG

Jyllandsstævne 2011 - riffel

Aalborg Skyttekreds

Prøveskud

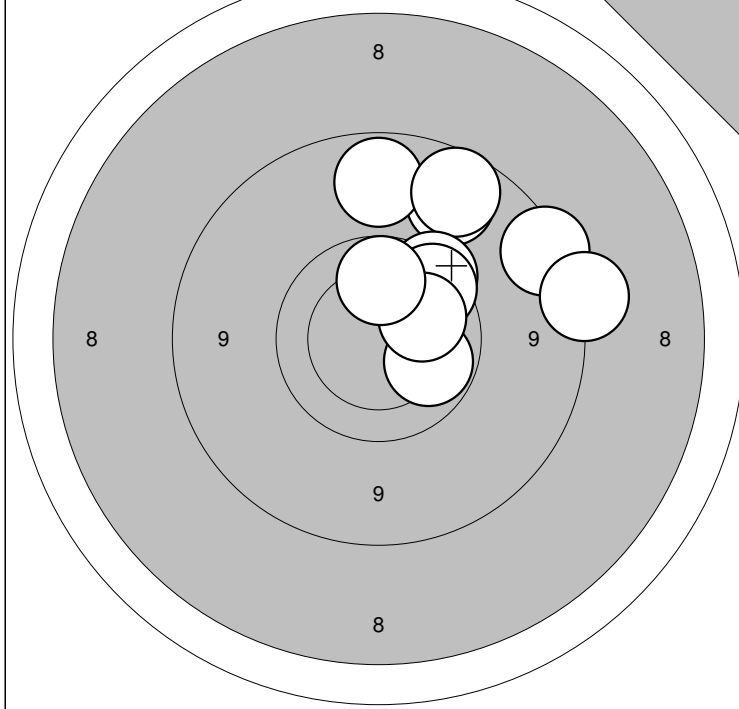

Prøveskud

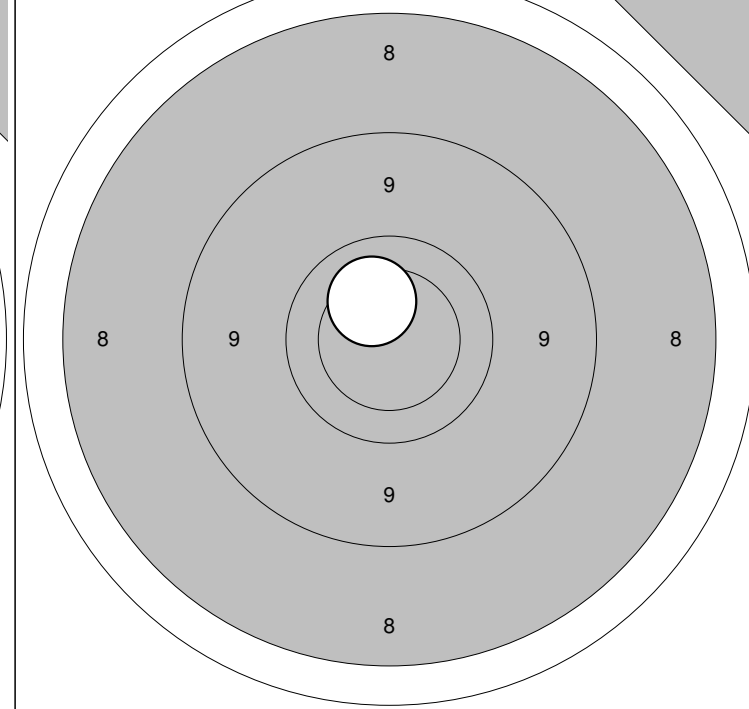

1: 9,0 ↗	6:10,0 ➡	Serie: 90,0
2: 8,8 ➔	7: 9,7 ↗	
3: 8,6 ➔	8: 9,8 ↗	Sum: 0,0
4: 9,0 ↑	9:10,1 ➔	
5: 8,9 ↗	10:10,0 ↑	

11:10,2 ↖	Serie: 10,0
	Sum: 0,0

Gældende

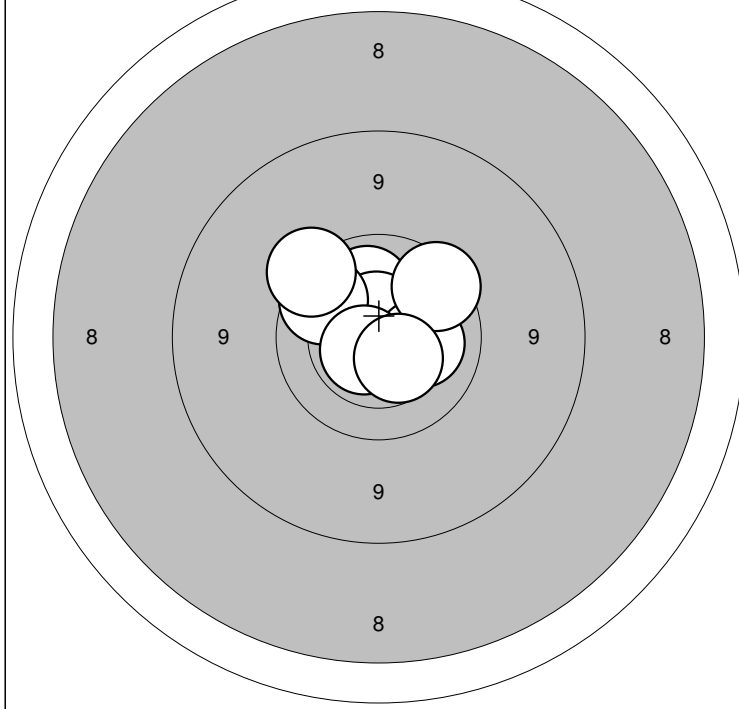

Gældende

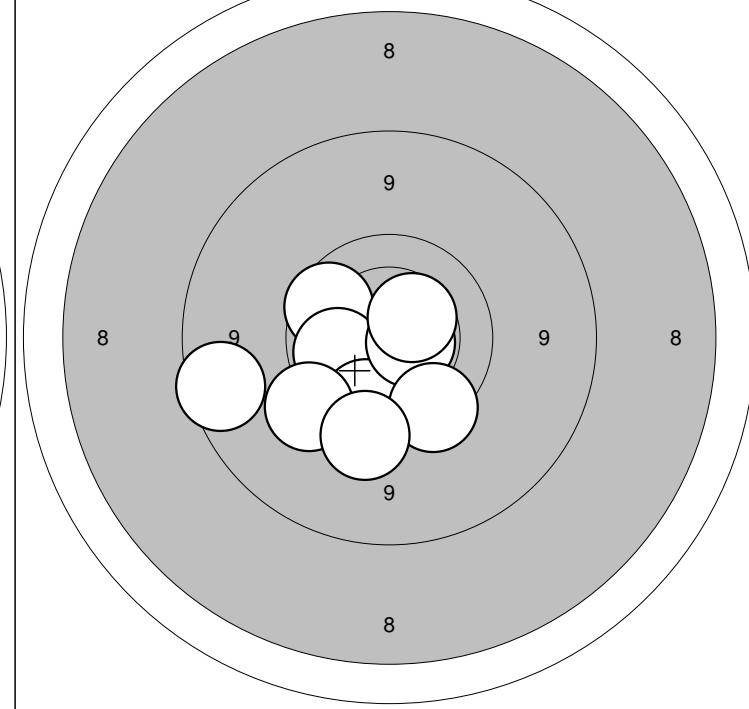

1:10,7* ↗	6: 9,9 ↖	Serie: 97,0
2:10,3 ↗	7: 9,6 ↖	
3:10,1 ↑	8: 9,8 ↗	Sum: 97,0
4:10,6* ↑	9:10,6* ↖	
5:10,2 ➔	10:10,4 ↘	

11:10,3 ←	16: 9,5 ↖	Serie: 93,0
12: 9,9 ↖	17:10,6* ➔	
13:10,0 ←	18: 9,7 ↘	Sum: 190,0
14: 9,8 ↘	19:10,4 ↗	
15: 8,9 ←	20: 9,5 ↘	

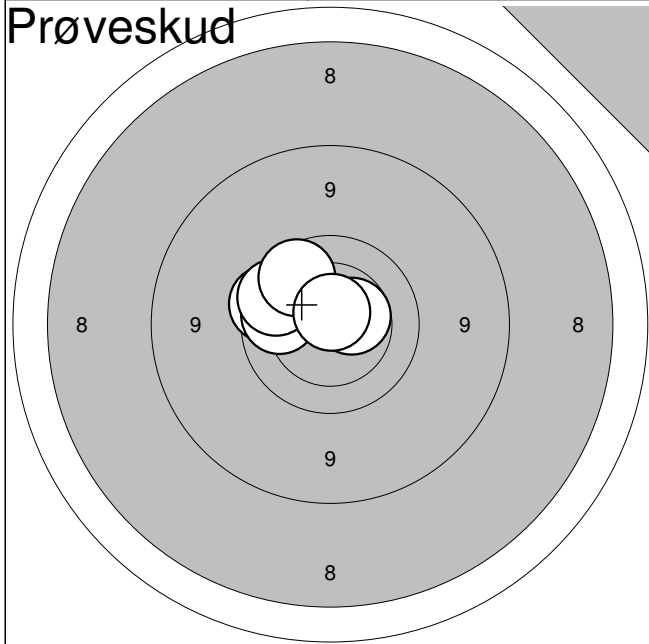

1:	9,8	↖
2:	10,0	↖
3:	9,8	↗
4:	9,9	↗
5:	10,5*	↗
6:	10,7*	↑

Serie:	57,0
Sum:	0,0

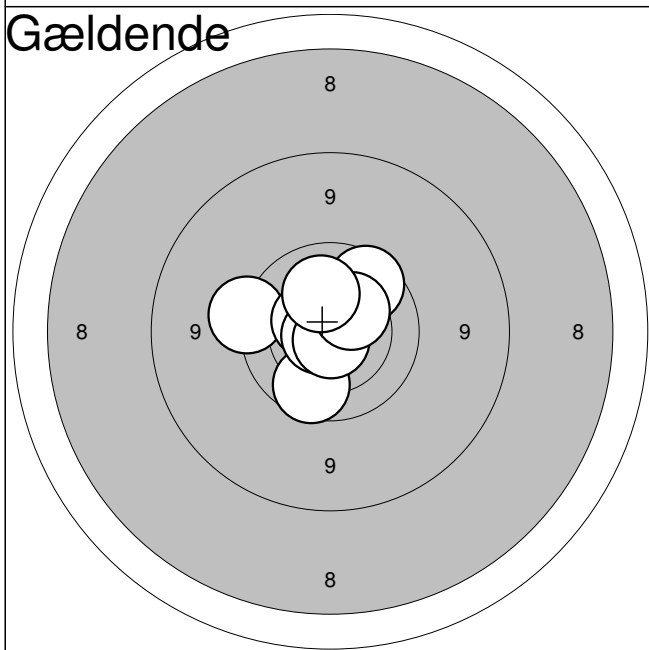

1:	10,4	↑
2:	10,8*	↗
3:	9,9	↓
4:	9,6	↖
5:	10,5*	↖
6:	10,7*	↖
7:	9,9	↗
8:	10,8*	↓
9:	10,4	↗
10:	10,2	↑

Serie:	97,0
Sum:	97,0

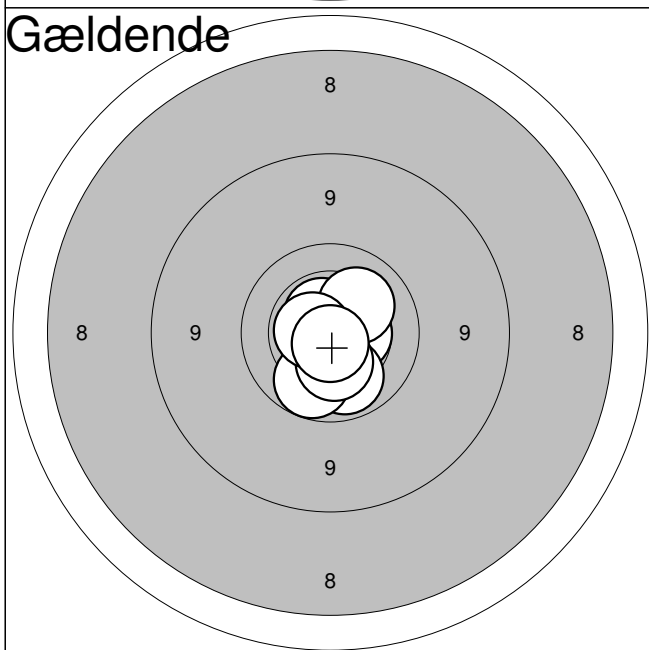

11:	10,5*	→
12:	10,6*	↑
13:	10,2	↗
14:	10,4	↓
15:	10,2	↓
16:	10,0	↓
17:	10,0	↓
18:	10,4	↓
19:	10,6*	↖
20:	10,7*	↓

Serie:	100,0
Sum:	197,0

Hold

57

Bane

8

Jessica Lindqvist

Fræer og Omegns Skf.

ÅK1

Jyllandsstævne 2011 - riffel

Aalborg Skyttekreds

Prøveskud

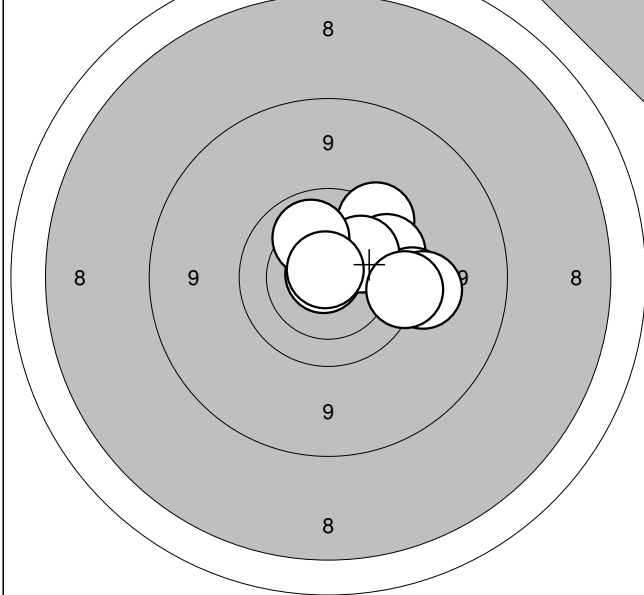

1:	9,7	↗
2:	9,8	→
3:	10,8*	↗
4:	9,6	→
5:	10,2	↗
6:	10,1	↗
7:	9,4	→
8:	10,8*	↗
9:	9,7	→

Serie: 85,0

Sum: 0,0

Gældende

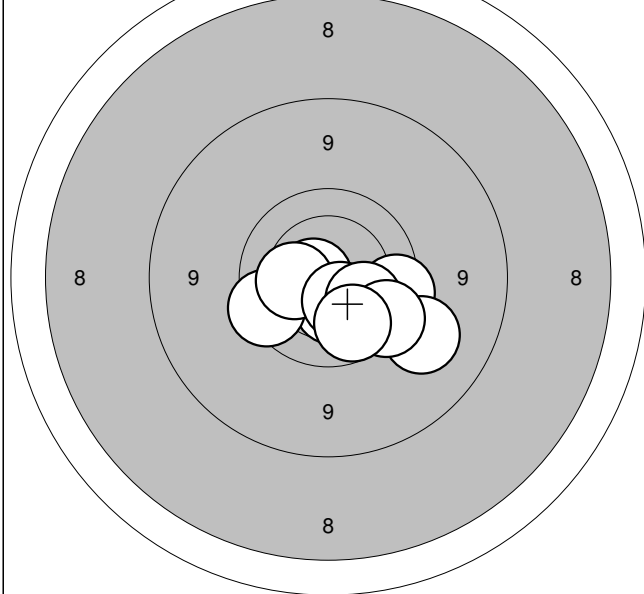

1:	10,4	↓
2:	9,7	→
3:	10,7*	←
4:	9,8	↙
5:	10,3	←
6:	9,3	↘
7:	10,4	↘
8:	10,1	↘
9:	9,7	↘
10:	9,9	↘

Serie: 95,0

Sum: 95,0

Gældende

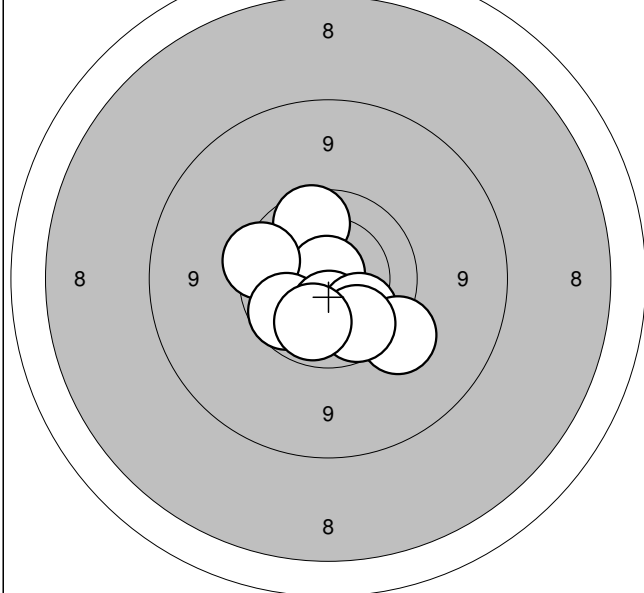

11:	9,9	↗
12:	10,6*	↓
13:	10,9*	↗
14:	9,8	←
15:	9,9	↙
16:	10,3	↘
17:	10,1	↘
18:	9,5	↘
19:	9,9	↘
20:	10,0	↘

Serie: 95,0

Sum: 190,0

Jyllandsstævne 2011

Hold
57

Bane
9

Winnie Therkildsen

D.F.B. Aalborg

V1

Jyllandsstævne 2011 - riffel

Aalborg Skyttekreds

Prøveskud

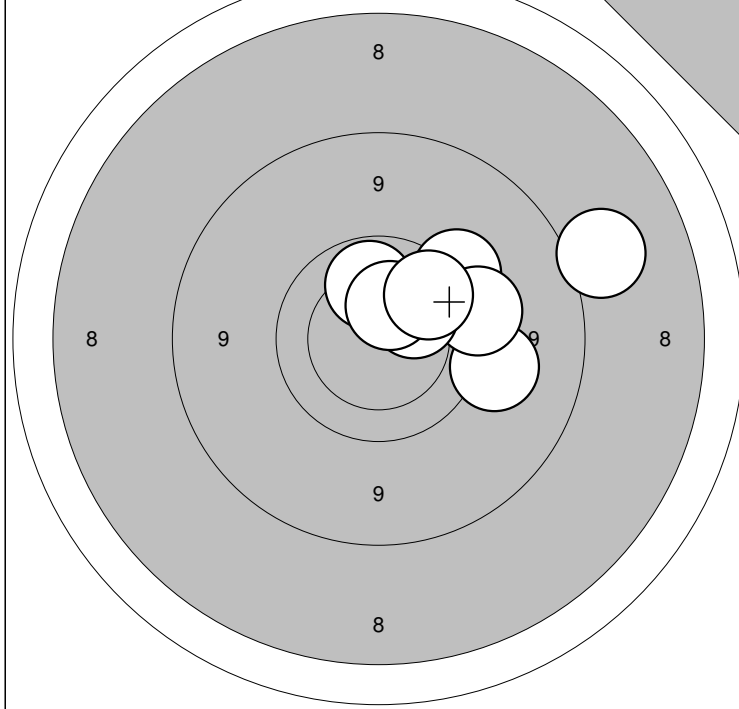

Prøveskud

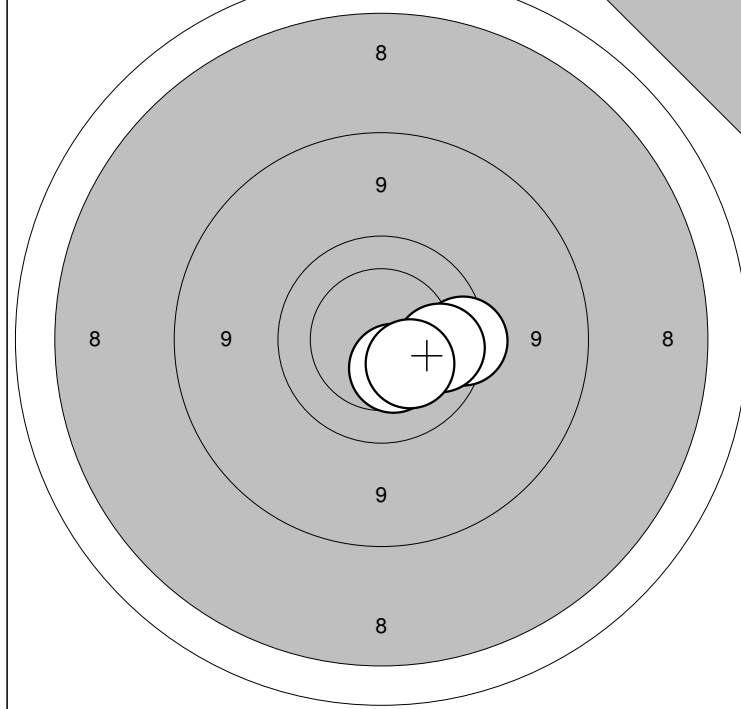

1: 9,4	→	6: 8,5	→
2: 9,8	↗	7: 10,1	↗
3: 9,5	↗	8: 10,2	↗
4: 10,0	↑	9: 10,4	↑
5: 9,5	→	10: 9,9	↗

Serie: 93,0
Sum: 0,0

11: 10,4	↓
12: 9,7	→
13: 9,9	→
14: 10,3	↓

Serie: 38,0
Sum: 0,0

Gældende

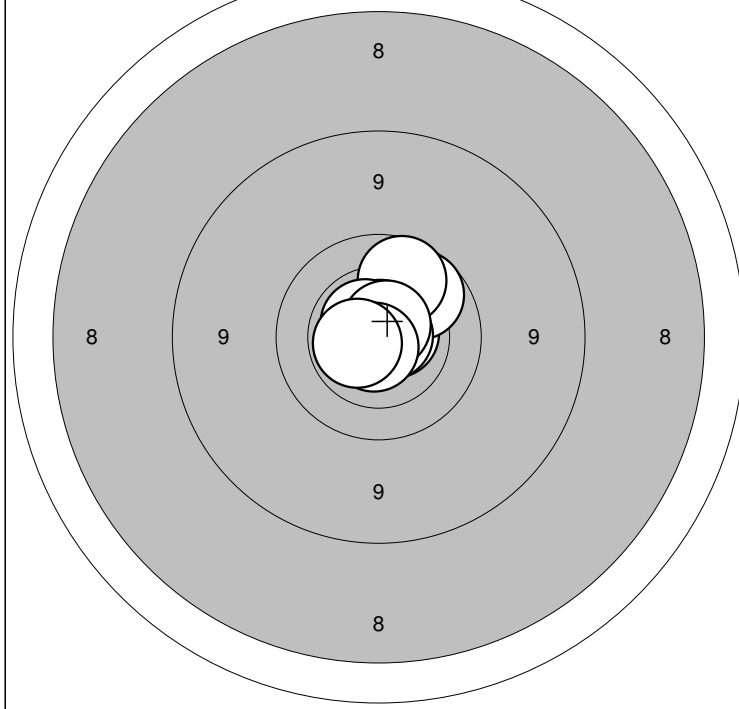

Gældende

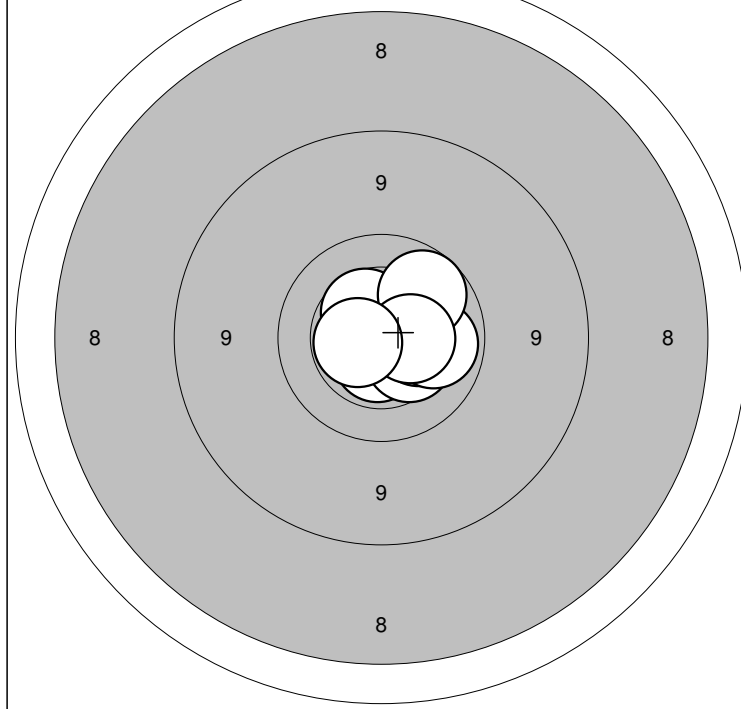

1: 10,7*	→	6: 10,7*	↑
2: 10,2	↗	7: 10,6*	↖
3: 9,9	↗	8: 10,7*	↗
4: 9,9	↑	9: 10,8*	↓
5: 10,8*	→	10: 10,6*	←

Serie: 98,0
Sum: 98,0

11: 10,6*	↓	16: 10,3	→
12: 10,3	↗	17: 10,1	→
13: 10,6*	↑	18: 9,9	↗
14: 10,5	↗	19: 10,4	→
15: 10,4	↓	20: 10,6*	←

Serie: 99,0
Sum: 197,0

Jyllandsstævne 2011

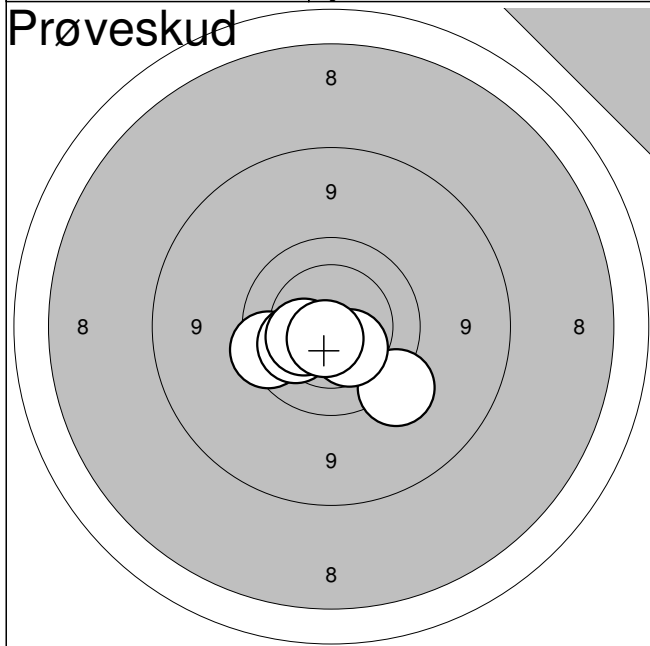

1:	9,5	↘
2:	9,8	←
3:	10,2	←
4:	10,4	↘
5:	10,4	←
6:	10,7*	↘

Serie:	58,0
Sum:	0,0

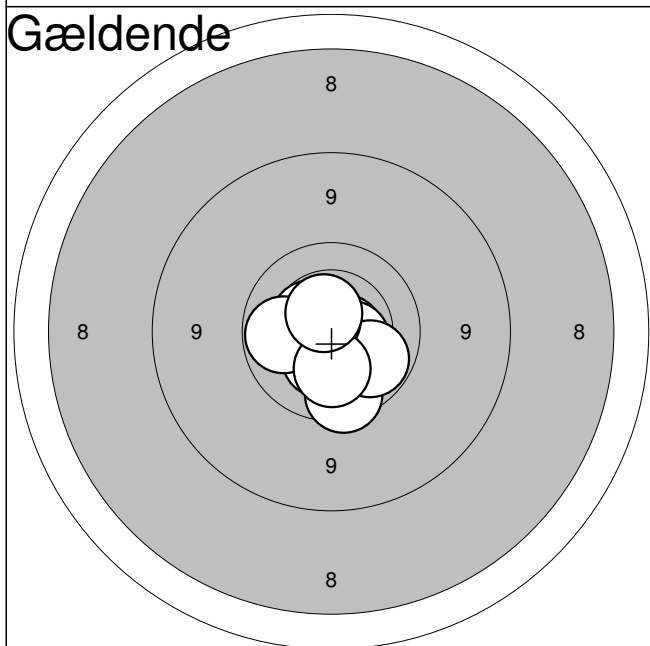

1:	9,8	↘
2:	10,7*	→
3:	10,5	↗
4:	10,4	↘
5:	10,5*	↘
6:	10,0	↘
7:	10,7*	↗
8:	10,0	←
9:	10,2	↘
10:	10,6*	↗

Serie:	99,0
Sum:	99,0

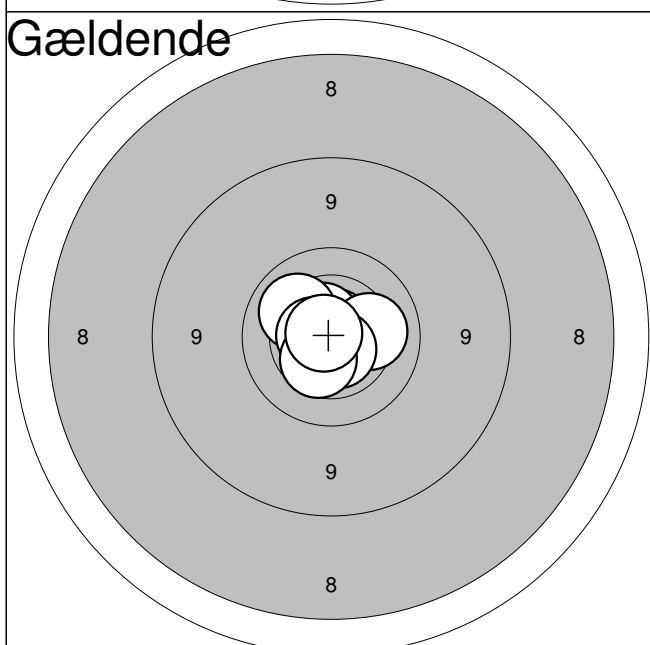

11:	10,7*	↗
12:	10,6*	↗
13:	10,9*	↘
14:	10,1	↗
15:	10,2	→
16:	10,8*	←
17:	10,7*	↘
18:	10,6*	←
19:	10,4	↘
20:	10,8*	↗

Serie:	100,0
Sum:	199,0

Hold
57

Bane
11

Allan Prior

D.F.B. Aalborg

V2

Jyllandsstævne 2011 - riffel

Aalborg Skyttekreds

Prøveskud

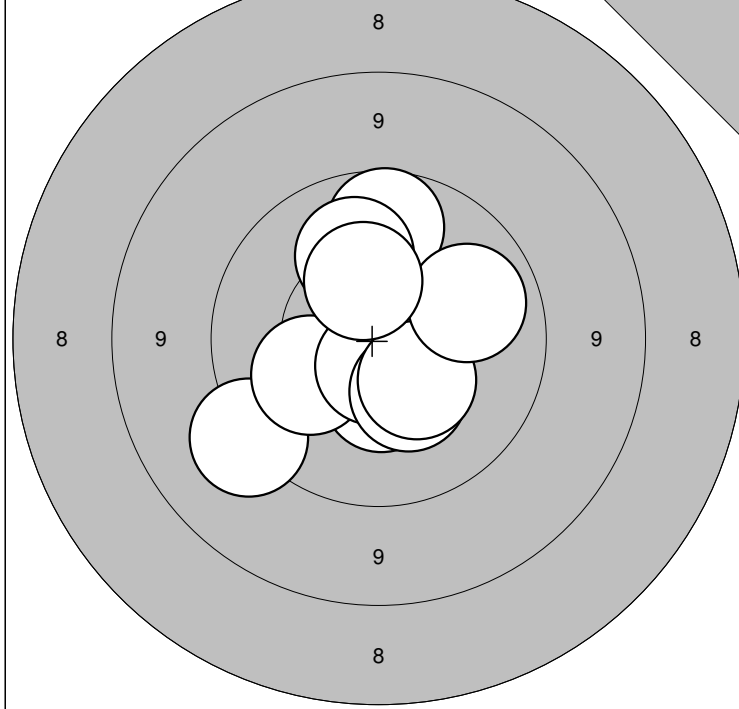

Prøveskud

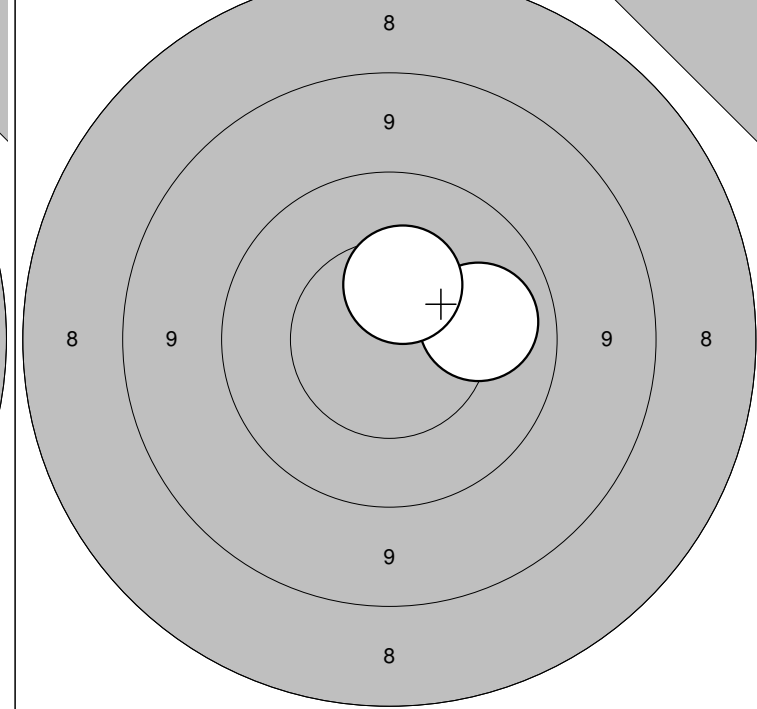

1: 9,4 ↙
 2: 10,4 ↓
 3: 10,2 ↖
 4: 10,7* ↓
 5: 10,4 ↘

6: 10,4 ↘
 7: 9,9 ↑
 8: 10,1 →
 9: 10,2 ↑
 10: 10,4 ↑

Serie: 98,0
 Sum: 0,0

11: 10,1 →
 12: 10,4 ↑

Serie: 20,0
 Sum: 0,0

Gældende

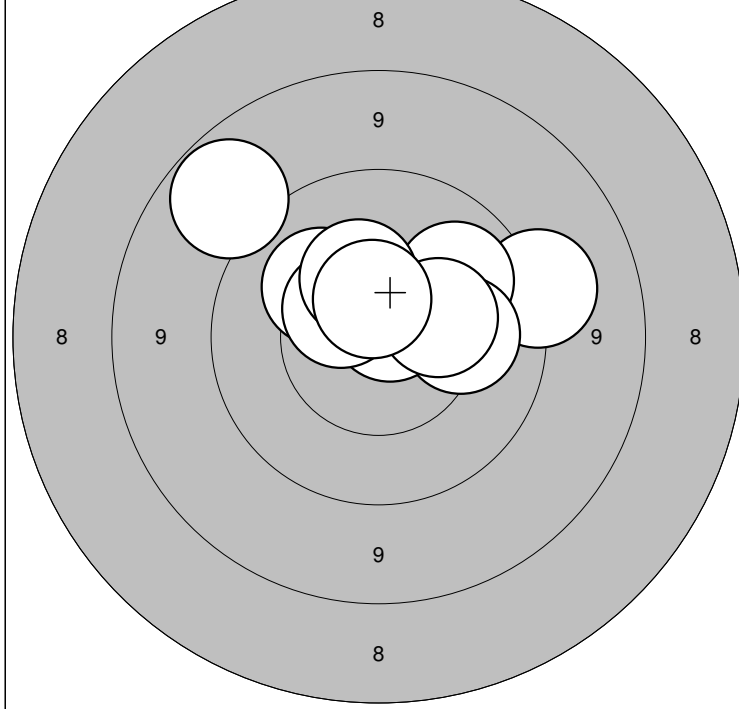

Gældende

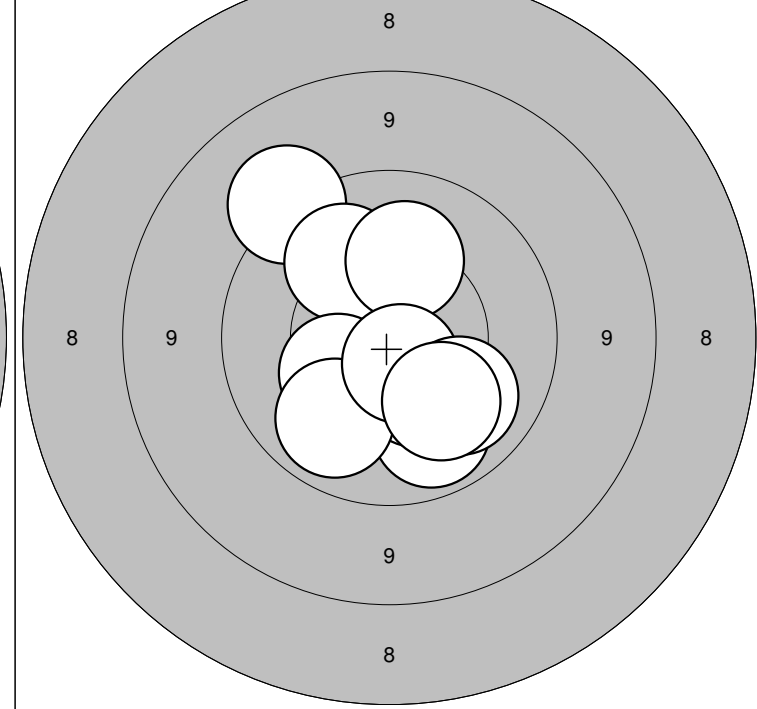

1: 9,4 →
 2: 9,0 ↖
 3: 10,2 ↖
 4: 10,1 ↗
 5: 10,2 →

6: 10,8* ↗
 7: 10,5 ↖
 8: 10,4 ↑
 9: 10,4 →
 10: 10,6* ↑

Serie: 98,0
 Sum: 98,0

11: 9,4 ↗
 12: 10,1 ↗
 13: 10,2 ↑
 14: 10,0 ↓
 15: 10,4 ↖

16: 10,4 ↓
 17: 10,1 ↓
 18: 10,7* ↓
 19: 10,1 ↓
 20: 10,2 ↓

Serie: 99,0
 Sum: 197,0

Horsens-Hammer Skf.

J2

Jyllandsstævne 2011 - riffel

Aalborg Skyttekreds

Prøveskud

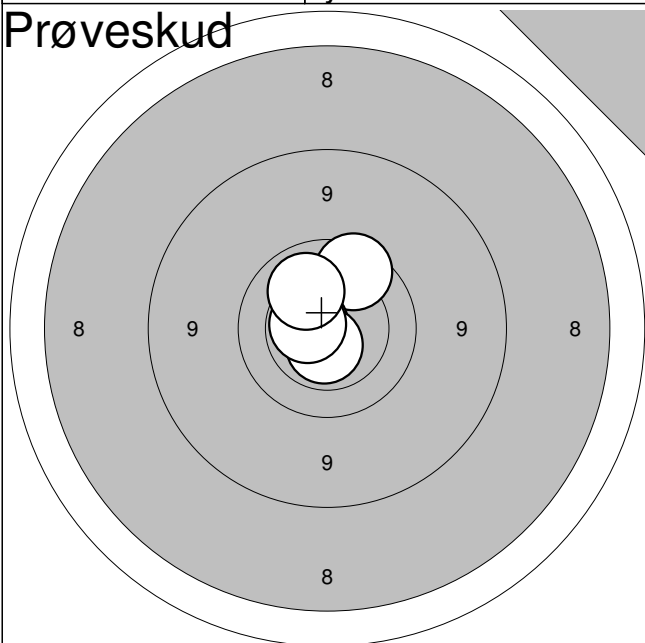

1:	9,8	↗
2:	10,6*	↖
3:	10,6*	↘
4:	10,6*	↖
5:	10,1	↗

Serie: 49,0

Sum: 0,0

Gældende

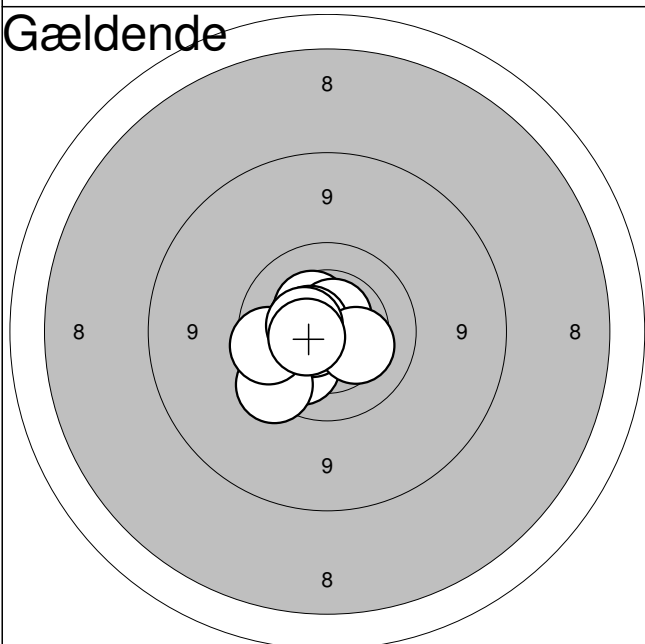

1:	10,4	↗
2:	10,1	↘
3:	10,6*	↖
4:	10,7*	↗
5:	9,7	↘
6:	9,9	↖
7:	10,6*	↖
8:	10,3	↘
9:	10,5*	↖
10:	10,5*	↖

Serie: 98,0

Sum: 98,0

Gældende

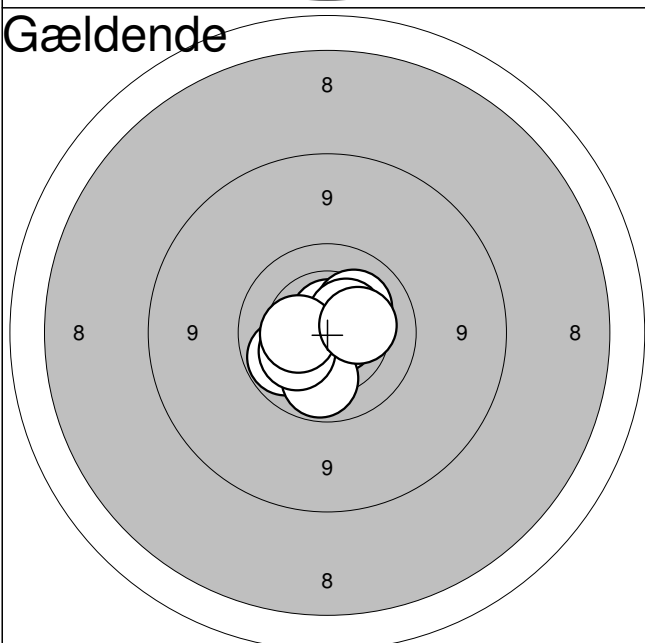

11:	10,6*	↗
12:	10,7*	↗
13:	10,2	↗
14:	10,7*	↘
15:	10,0	↖
16:	10,0	↘
17:	10,3	↖
18:	10,5	↗
19:	10,4	↖
20:	10,3	↗

Serie: 100,0

Sum: 198,0

Hold

58

Bane

1

René Jensen

Horsens-Hammer Skf.

ÅK2

Jyllandsstævne 2011 - riffel

Aalborg Skyttekreds

Prøveskud

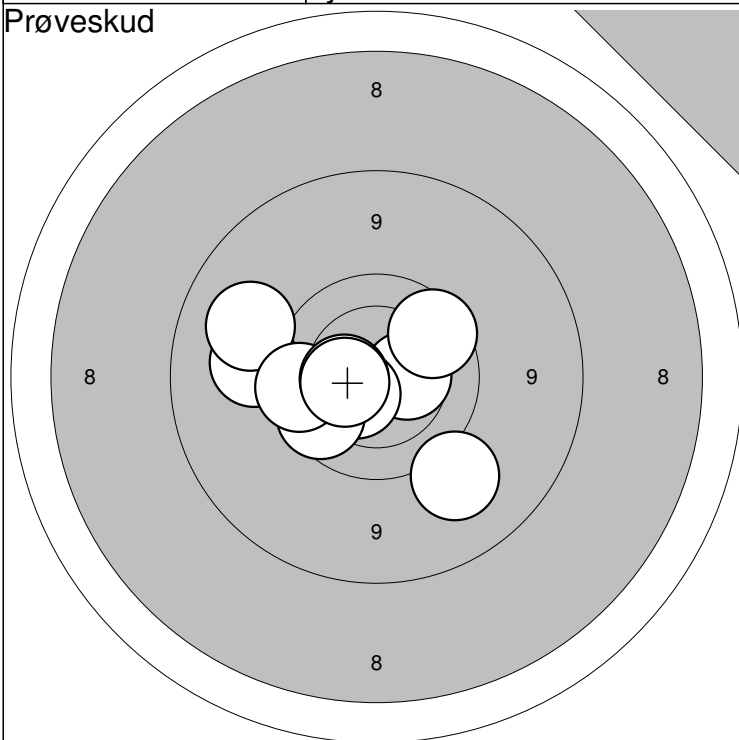

Prøveskud

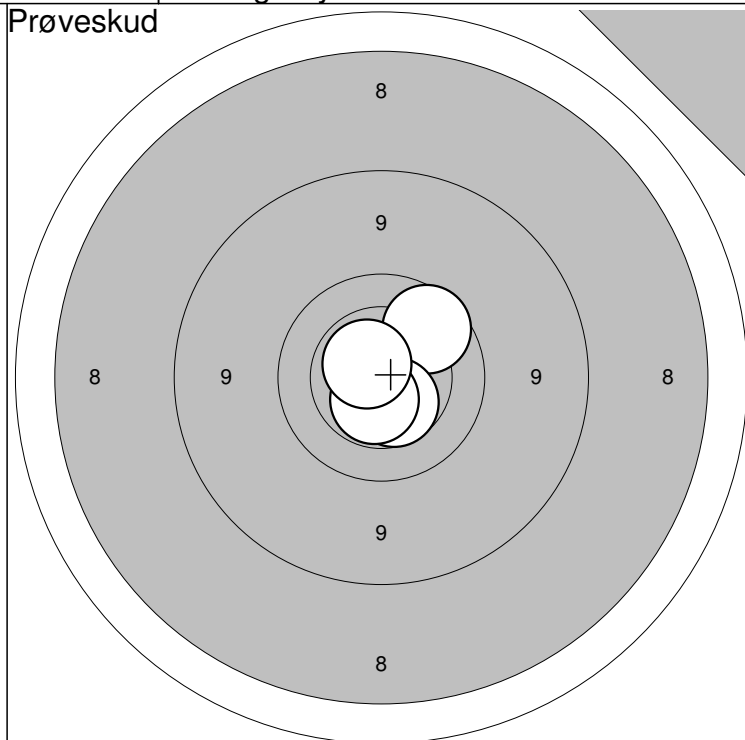

1: 9,3



6: 9,9



Serie: 94,0

2: 10,4



7: 9,2



11: 9,9



Serie: 39,0

3: 9,8



8: 9,8



12: 10,5



4: 9,3



9: 10,4



Sum: 0,0

13: 10,6*



5: 10,5*



10: 10,4



14: 10,6*



Sum: 0,0

Gældende

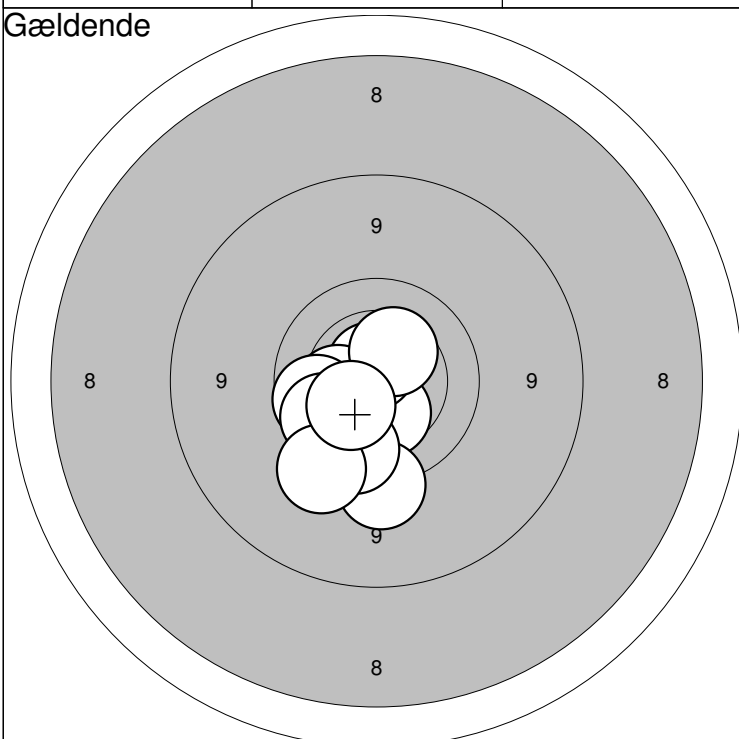

Gældende

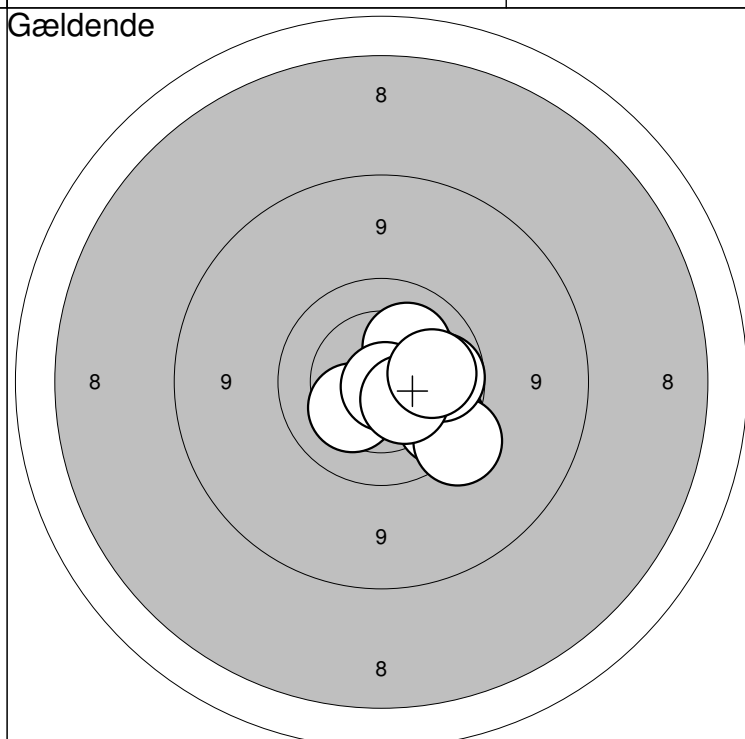

1: 10,4



6: 10,4



Serie: 95,0

2: 10,7*



7: 9,8



11: 9,8



16: 10,2



Serie: 97,0

3: 10,3



8: 9,9



12: 10,3



17: 10,8*



4: 9,9



9: 9,5



Sum: 95,0

13: 10,7*



18: 9,9



5: 9,5



10: 10,3



14: 9,6



19: 10,4



Sum: 192,0

15: 10,3



20: 10,1



Jyllandsstævne 2011

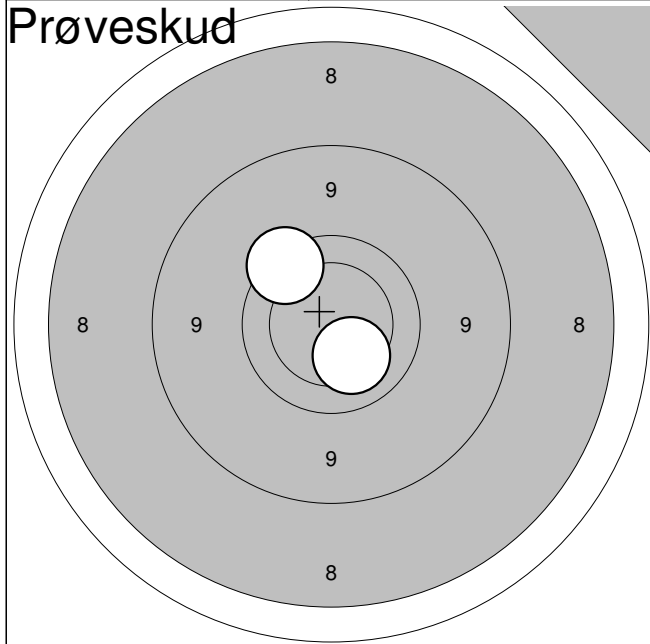

1:	9,7	↗
2:	10,2	↘

Serie:	19,0
Sum:	0,0

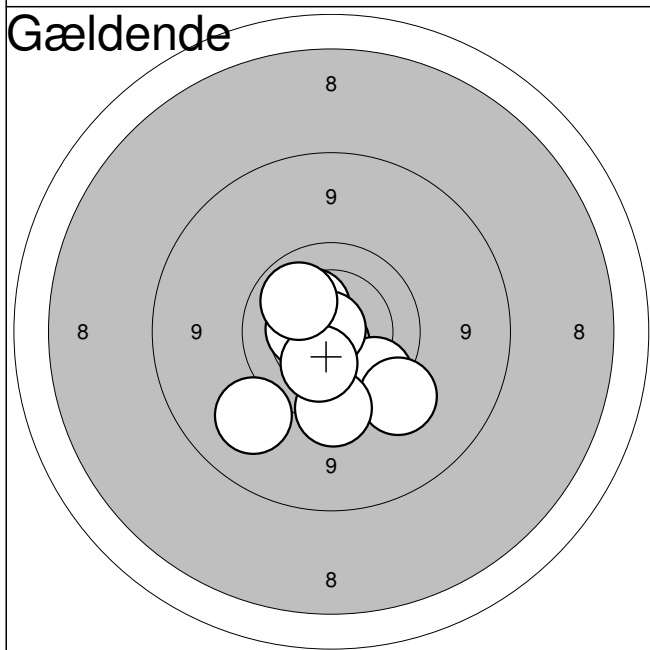

1:	10,7*	↓
2:	10,3	↗
3:	9,8	↘
4:	10,4	←
5:	9,5	↘
6:	9,2	↘
7:	10,9*	↗
8:	9,7	↓
9:	10,3	↘
10:	10,1	↗

Serie:	96,0
Sum:	96,0

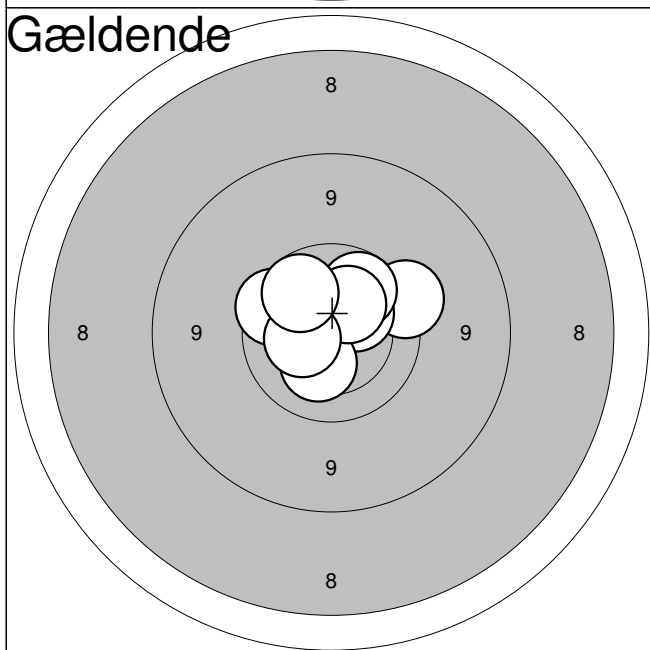

11:	10,4	↗
12:	9,6	→
13:	10,3	↗
14:	10,3	↗
15:	10,0	↗
16:	10,3	↘
17:	9,8	←
18:	10,3	↗
19:	10,4	←
20:	10,0	↗

Serie:	98,0
Sum:	194,0

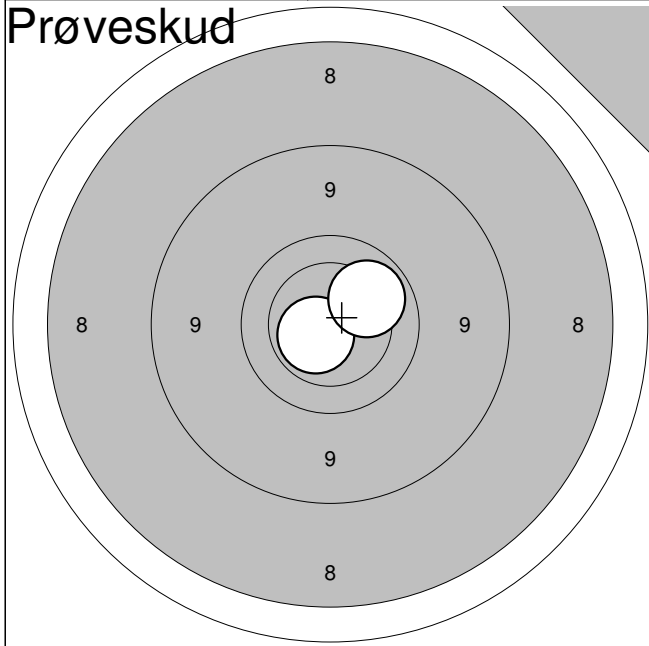

1:	10,6*	↙
2:	10,1	↗

Serie:	20,0
Sum:	0,0

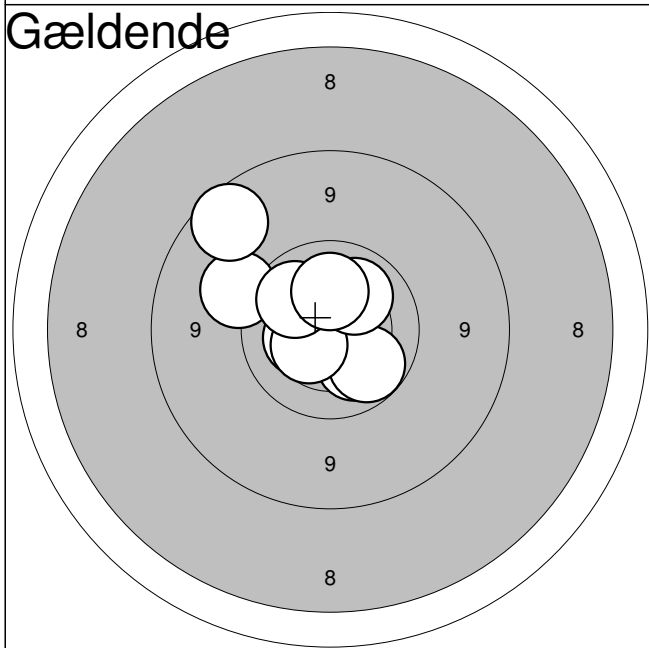

1:	10,1	↘
2:	10,4	←
3:	10,1	↘
4:	10,0	↘
5:	9,4	↗
6:	8,9	↗
7:	10,4	↙
8:	10,0	↗
9:	10,1	↗
10:	10,2	↑

Serie:	97,0
Sum:	97,0

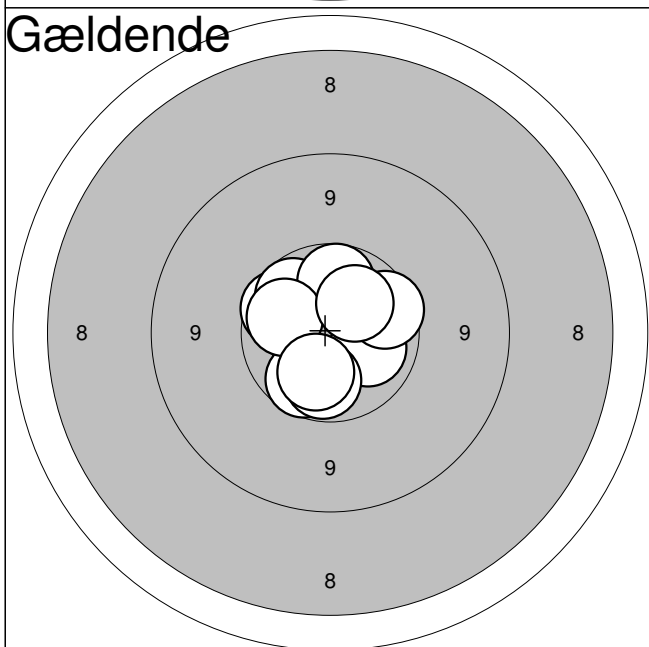

11:	10,1	↘
12:	9,9	↖
13:	10,0	↗
14:	9,9	↘
15:	10,0	↘
16:	10,0	↑
17:	9,9	→
18:	10,0	←
19:	10,1	↘
20:	10,2	↗

Serie:	97,0
Sum:	194,0

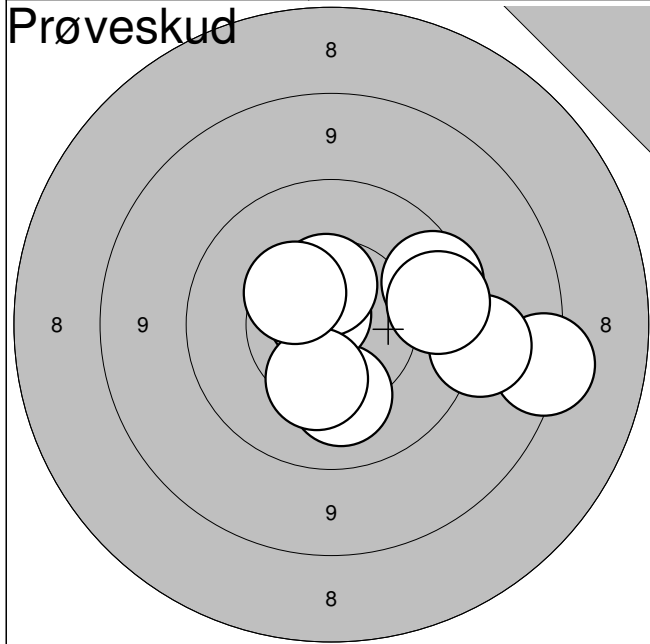

1:	9,8	→
2:	10,2	↓
3:	10,8*	↗
4:	8,5	→
5:	10,5	↑
6:	9,3	→
7:	9,8	→
8:	10,4	↓
9:	10,4	↗

Serie:	85,0
Sum:	0,0

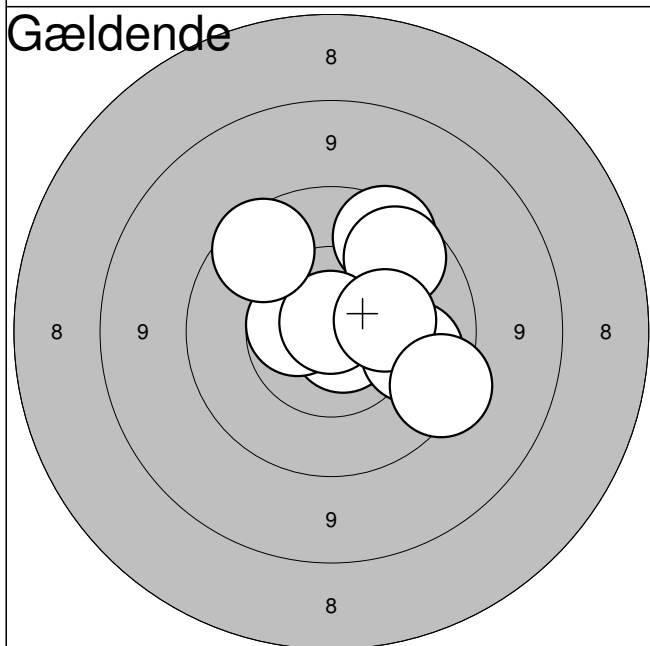

1:	10,5	→
2:	10,8*	↓
3:	10,1	→
4:	9,8	↗
5:	10,6*	←
6:	9,9	↗
7:	10,9*	↑
8:	10,4	→
9:	9,8	↗
10:	9,6	↓

Serie:	96,0
Sum:	96,0

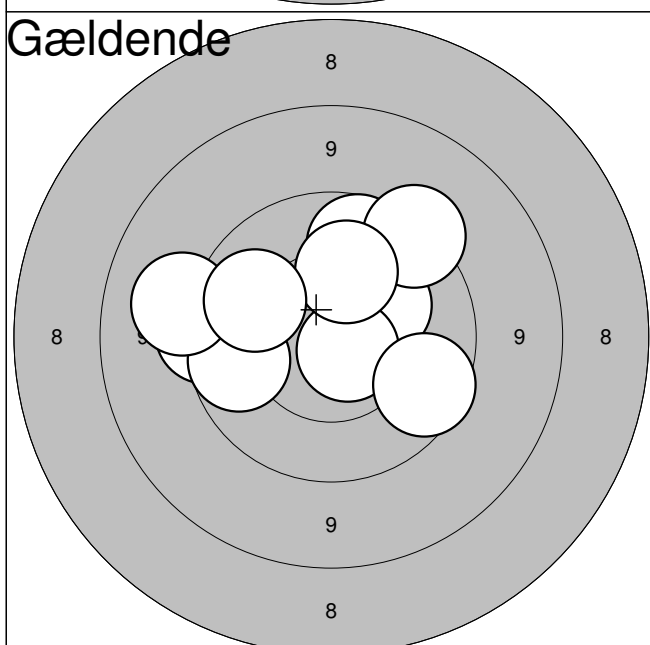

11:	9,9	↑
12:	10,3	↗
13:	10,7*	↓
14:	9,6	←
15:	9,9	←
16:	9,3	←
17:	9,5	↗
18:	9,8	↘
19:	10,2	↑
20:	10,1	←

Serie:	94,0
Sum:	190,0

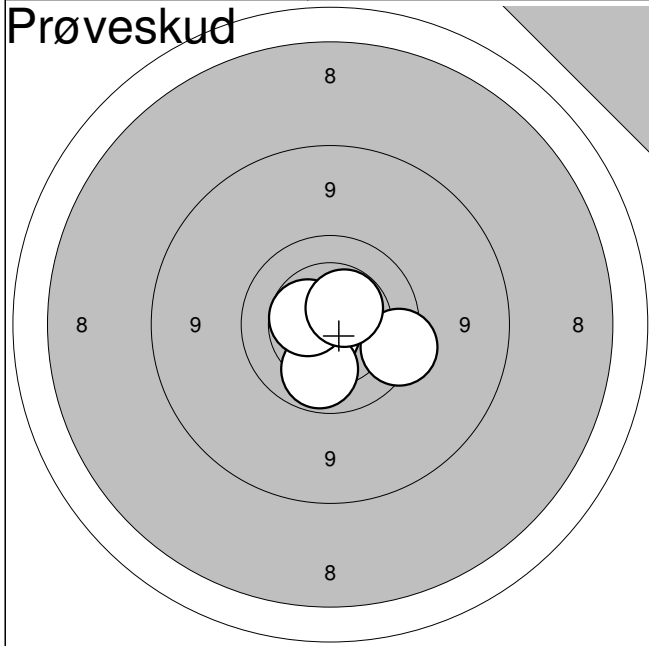

1:	10,7*	↘
2:	10,0	↓
3:	9,7	→
4:	10,5*	←
5:	10,5*	↗

Serie:	49,0
Sum:	0,0

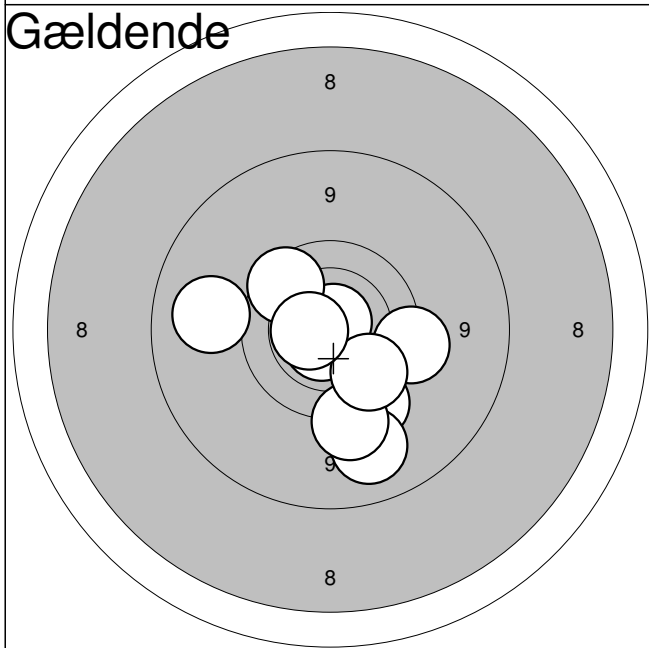

1:	9,6	→
2:	9,6	↓
3:	9,2	↓
4:	10,7*	↓
5:	10,8*	↗
6:	9,5	↓
7:	9,9	↓
8:	9,2	←
9:	9,8	↗
10:	10,5*	←

Serie:	93,0
Sum:	93,0

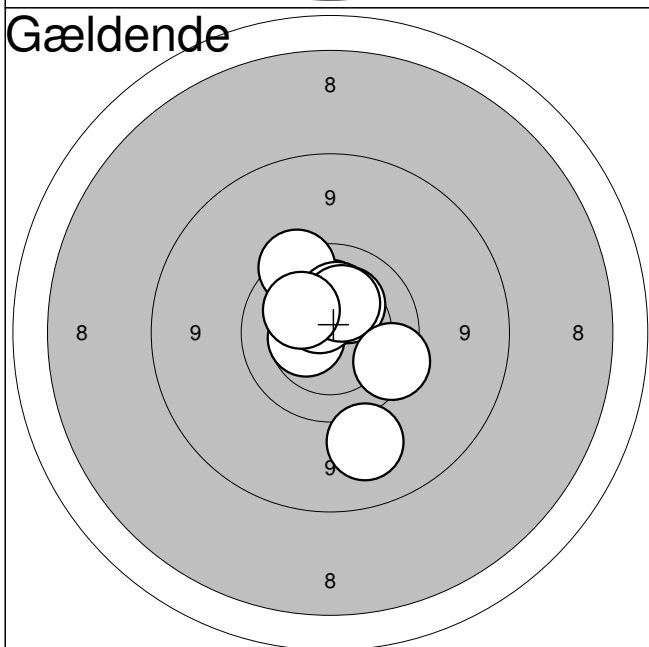

11:	10,3	↗
12:	10,5	←
13:	10,5*	↗
14:	10,3	↑
15:	9,7	↗
16:	10,3	↑
17:	10,3	↑
18:	10,2	↗
19:	9,8	↓
20:	9,2	↓

Serie:	97,0
Sum:	190,0

Hold
58Bane
7**Ann Olsen**

Aalborg Skyttekreds

ÅK2

Jyllandsstævne 2011 - riffel

Aalborg Skyttekreds

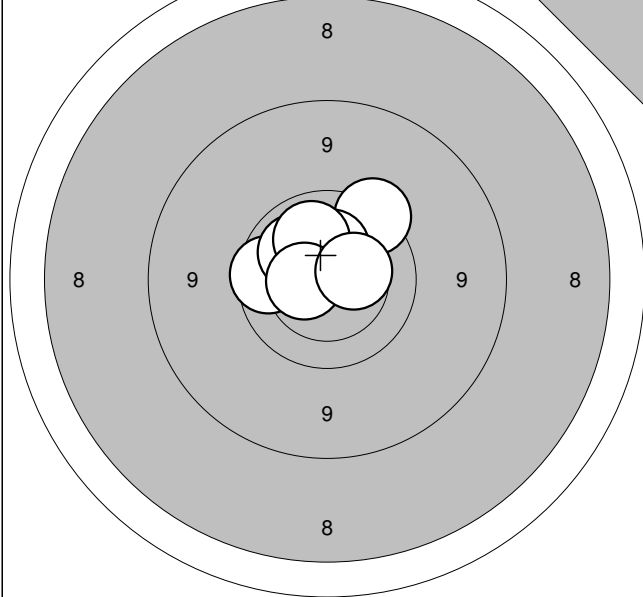
Prøveskud

1:	9,9	←
2:	10,2	↗
3:	9,7	↗
4:	10,3	↑
5:	10,1	↑
6:	10,5*	←
7:	10,4	→

Serie: 68,0

Sum: 0,0

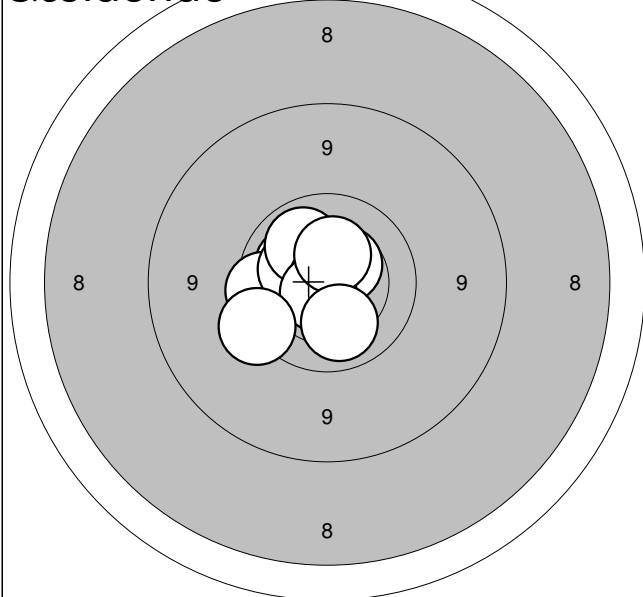
Gældende

1:	10,2	↗
2:	9,8	←
3:	10,3	↗
4:	10,1	↗
5:	10,9*	↑
6:	10,5	↗
7:	10,7*	↘
8:	10,4	↑
9:	9,6	←
10:	10,1	↓

Serie: 98,0

Sum: 98,0

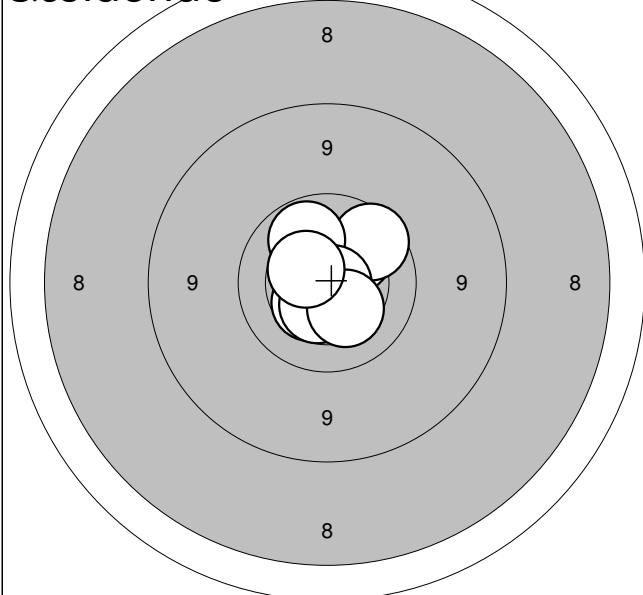
Gældende

11:	10,6*	↘
12:	10,2	↗
13:	10,7*	↘
14:	9,9	↗
15:	10,4	↘
16:	10,0	↗
17:	10,8*	→
18:	10,5	↘
19:	10,3	↘
20:	10,5	↗

Serie: 99,0

Sum: 197,0

Jyllandsstævne 2011

Hold

58

Bane

8

Jessica Lindqvist

Fræer og Omegns Skf.

ÅK1

Jyllandsstævne 2011 - riffel

Aalborg Skyttekreds

Prøveskud

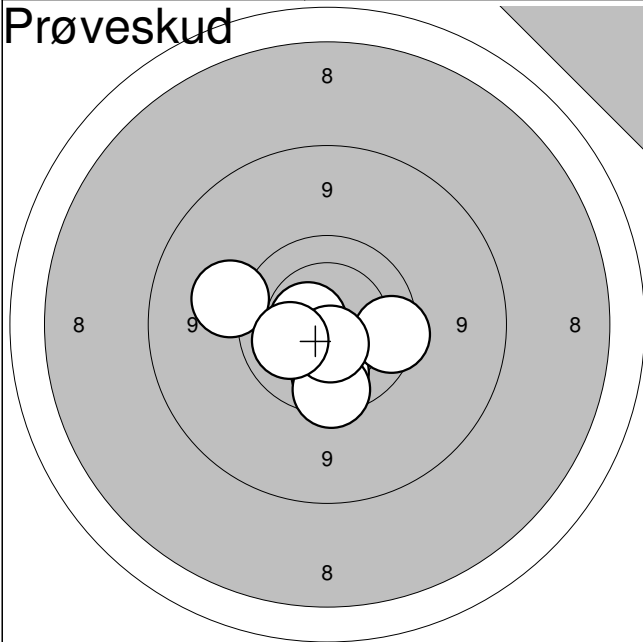

1: 10,0



2: 9,8



3: 9,8



4: 10,5



5: 10,6*



6: 10,6*



7: 9,4



8: 10,2



Serie: 77,0

Sum: 0,0

Gældende

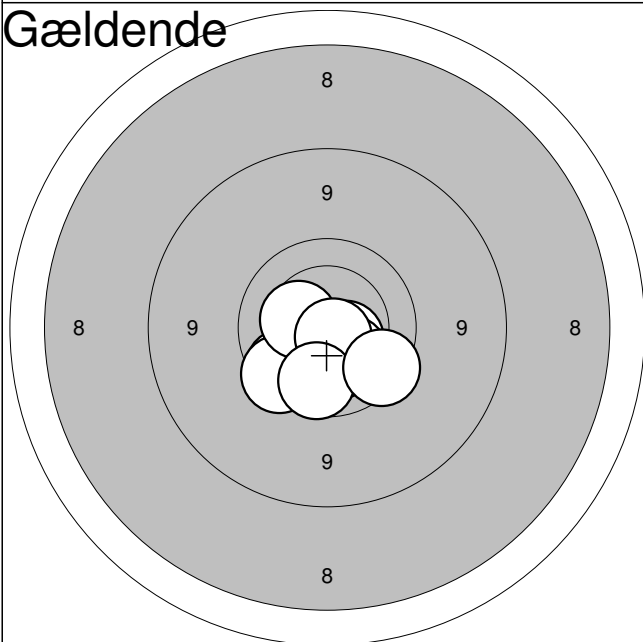

1: 10,3



2: 10,3



3: 10,5*



4: 9,9



5: 9,8



6: 10,4



7: 10,3



8: 10,7*



9: 9,9



10: 9,8



Serie: 96,0

Sum: 96,0

Gældende

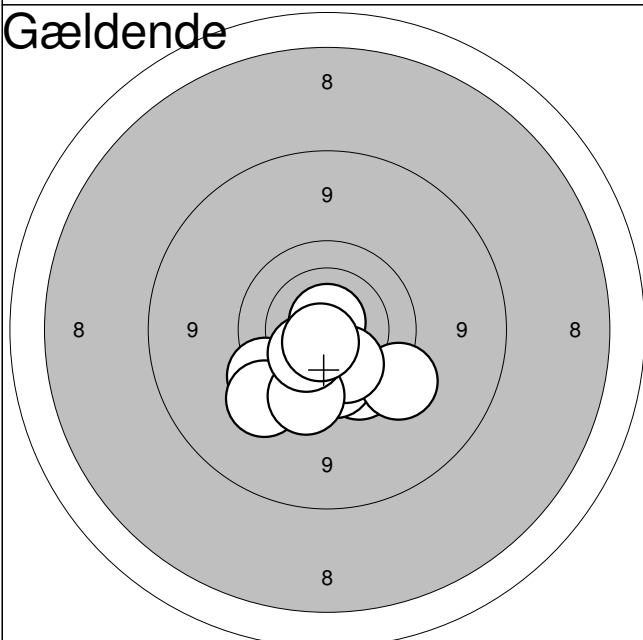

11: 9,8



12: 9,7



13: 10,8*



14: 9,9



15: 9,5



16: 9,5



17: 10,2



18: 9,7



19: 10,3



20: 10,7*



Serie: 94,0

Sum: 190,0

Jyllandsstævne 2011

Hold

58

Bane

9

Christian Frost

Aalborg Skyttekreds

ÅK2

Jyllandsstævne 2011 - riffel

Aalborg Skyttekreds

Prøveskud

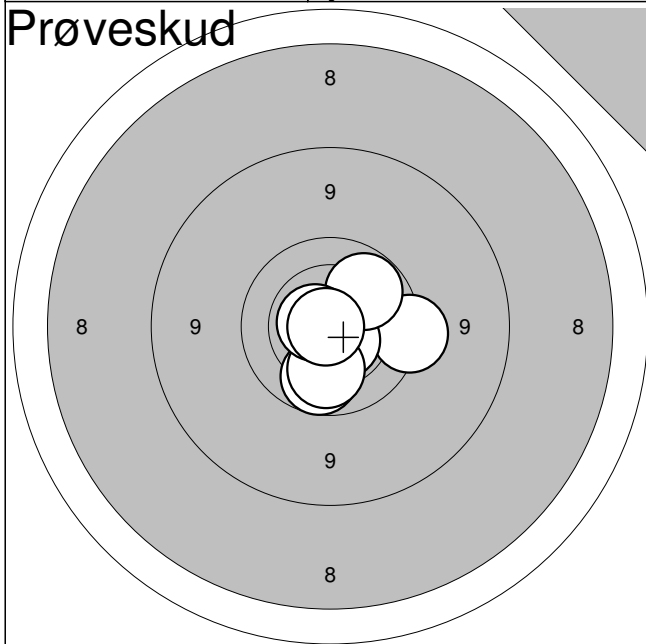

1:	9,6	→
2:	10,6*	↘
3:	9,9	↘
4:	10,1	↘
5:	10,0	↗
6:	10,6*	←
7:	10,9*	←

Serie: 68,0

Sum: 0,0

Gældende

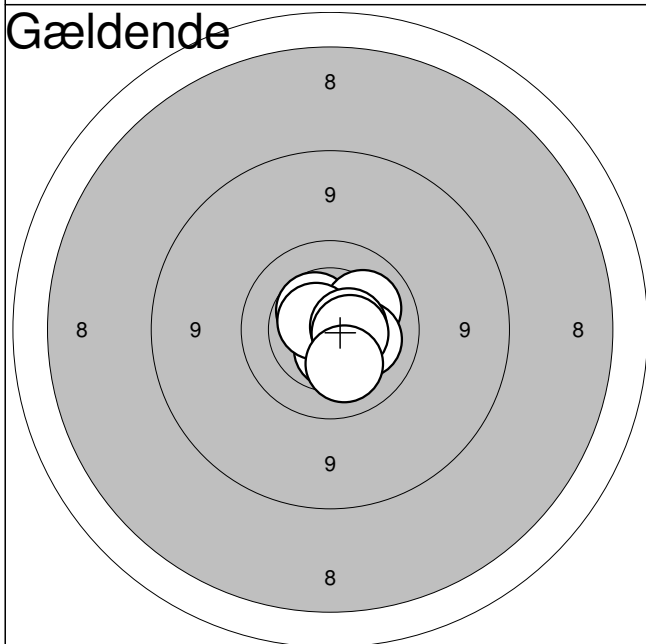

1:	10,7*	↘
2:	10,9*	↘
3:	10,6*	↘
4:	10,5	↗
5:	10,2	↗
6:	10,6*	↗
7:	10,3	→
8:	10,6*	→
9:	10,5*	→
10:	10,2	↘

Serie: 100,0

Sum: 100,0

Gældende

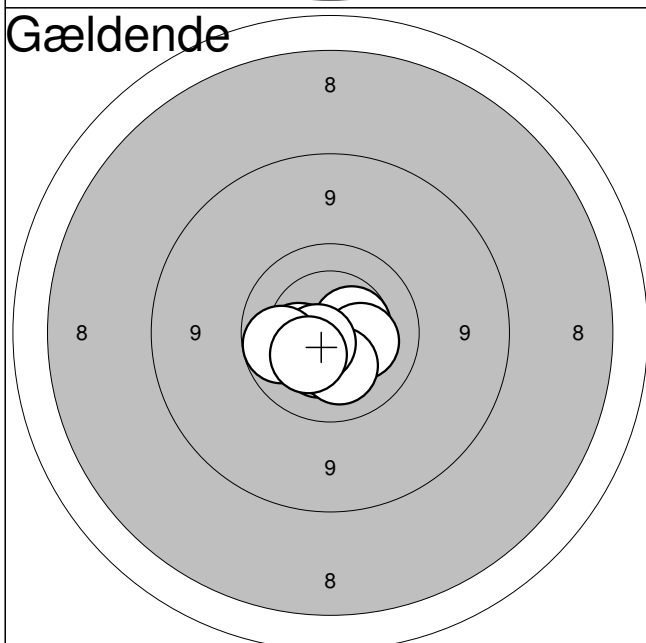

11:	10,4	←
12:	10,4	↘
13:	10,4	↘
14:	10,3	←
15:	10,5*	↗
16:	10,3	→
17:	10,3	↘
18:	10,6*	↘
19:	10,0	←
20:	10,3	↘

Serie: 100,0

Sum: 200,0

Jyllandsstævne 2011

Prøveskud

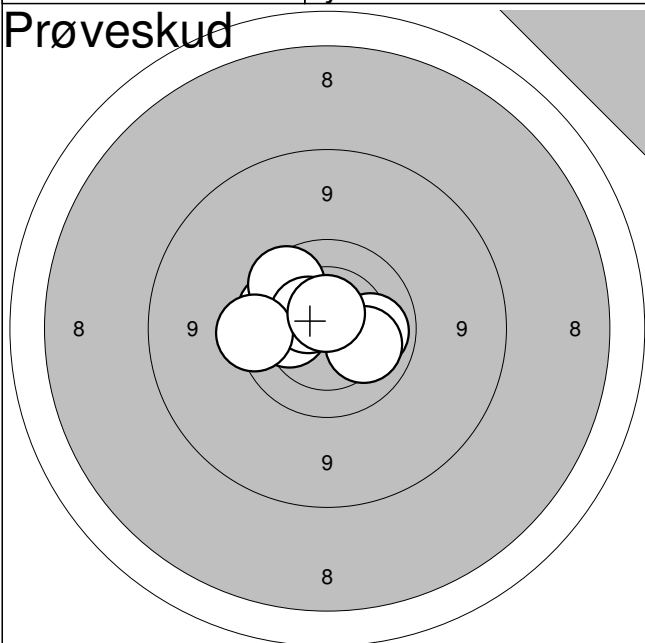

1:	9,9	←
2:	10,1	→
3:	10,2	→
4:	10,2	←
5:	9,9	↗
6:	10,5*	↗
7:	9,7	←
8:	10,7*	↑

Serie:	77,0
--------	------

Sum:	0,0
------	-----

Gældende

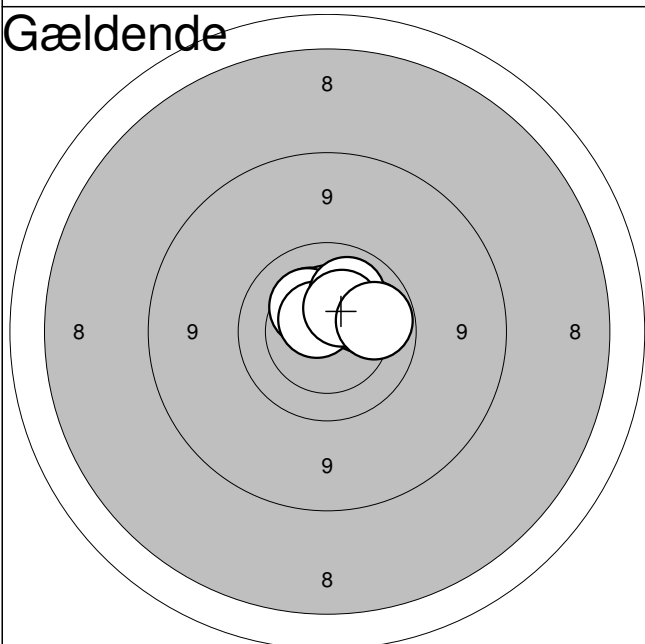

1:	10,1	→
2:	10,4	↗
3:	10,4	↑
4:	10,4	↗
5:	10,3	↗
6:	10,2	→
7:	10,7*	↗
8:	10,1	↗
9:	10,4	↗
10:	10,0	→

Serie:	100,0
--------	-------

Sum:	100,0
------	-------

Gældende

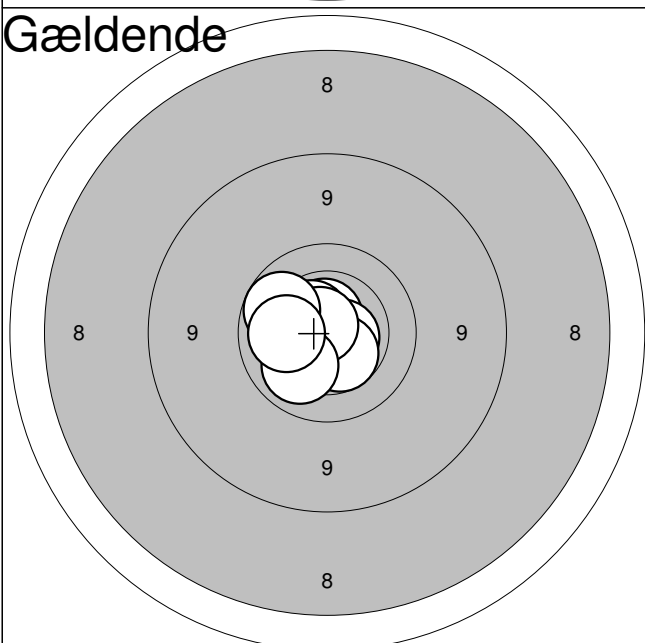

11:	10,6*	↑
12:	10,5*	←
13:	10,7*	←
14:	10,5*	↗
15:	10,7*	→
16:	10,5	↘
17:	10,7*	↗
18:	10,1	↘
19:	10,0	↗
20:	10,2	←

Serie:	100,0
--------	-------

Sum:	200,0
------	-------

Hold

58

Bane

11

Allan Prior

D.F.B. Aalborg

V1

Jyllandsstævne 2011 - riffel

Aalborg Skyttekreds

Prøveskud

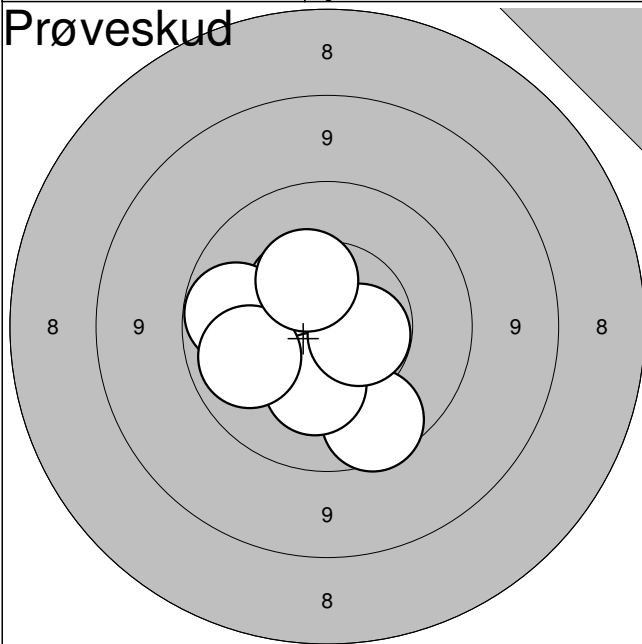

1:	10,5	↗
2:	9,8	↘
3:	10,5	←
4:	10,3	↘
5:	10,6*	→
6:	10,0	←
7:	10,1	←
8:	10,4	↗

Serie: 79,0

Sum: 0,0

Gældende

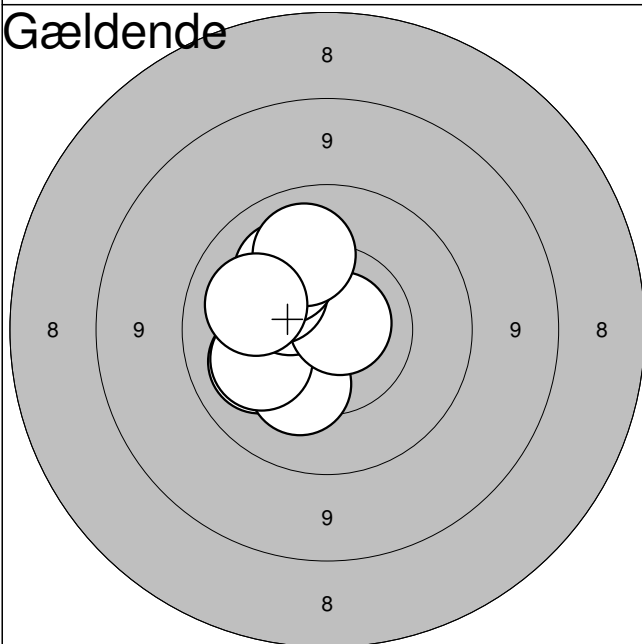

1:	10,2	←
2:	10,6	←
3:	10,3	↘
4:	10,2	←
5:	10,5	↗
6:	10,8*	→
7:	10,3	↗
8:	10,2	↗
9:	10,1	↗
10:	10,2	←

Serie: 100,0

Sum: 100,0

Gældende

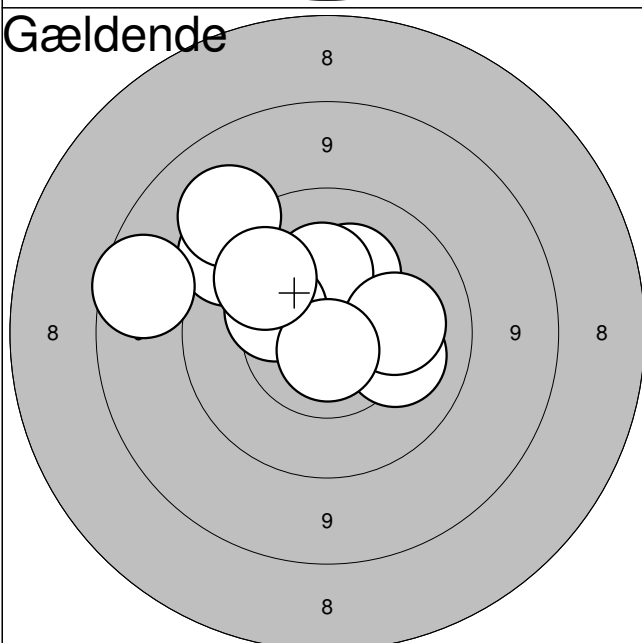

11:	10,3	↗
12:	9,6	↗
13:	10,3	↑
14:	10,4	↗
15:	10,2	→
16:	8,8	←
17:	10,2	→
18:	10,8*	↘
19:	9,3	↗
20:	10,1	↗

Serie: 96,0

Sum: 196,0

Jyllandsstævne 2011

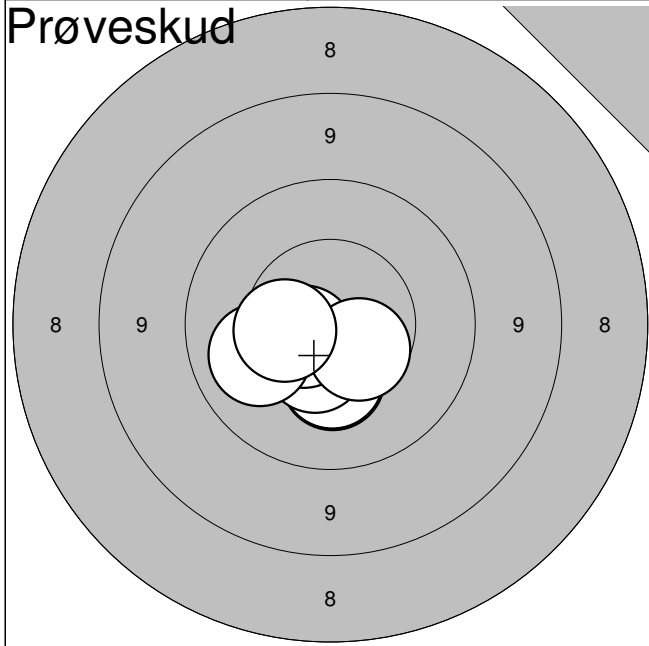

1:	10,4	↓
2:	10,4	↓
3:	10,5	↓
4:	10,6*	←
5:	10,1	←
6:	10,5	↓
7:	10,5	←

Serie:	70,0
Sum:	0,0

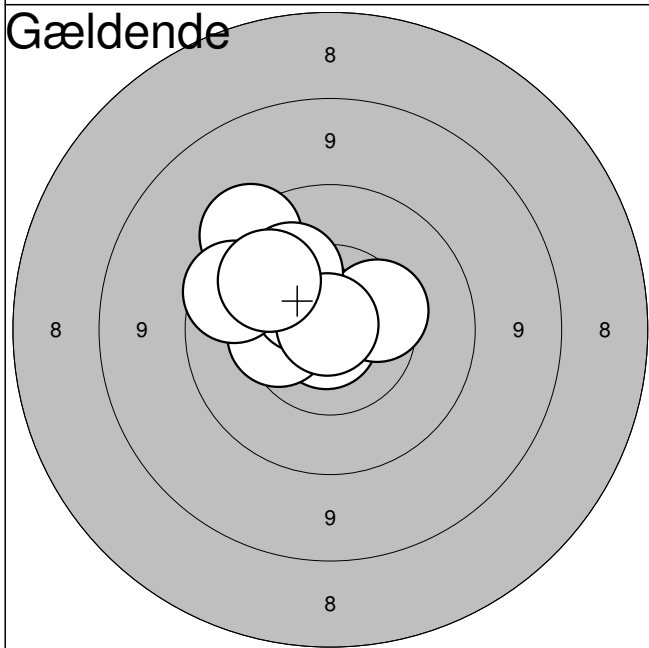

1:	9,6	↗
2:	10,5	↗
3:	10,9*	↓
4:	10,4	←
5:	10,5	↗
6:	9,9	↗
7:	10,4	→
8:	10,2	↗
9:	10,9*	↗
10:	10,1	↗

Serie:	98,0
Sum:	98,0

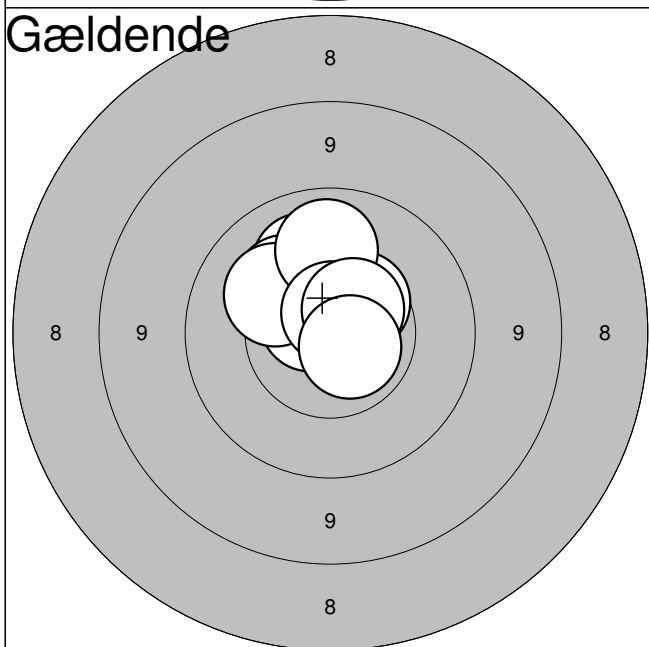

11:	10,5	↗
12:	10,5	↗
13:	10,2	↗
14:	10,3	↗
15:	10,7*	↗
16:	10,2	↗
17:	10,1	↑
18:	10,7*	↑
19:	10,6*	↗
20:	10,7*	↓

Serie:	100,0
Sum:	198,0

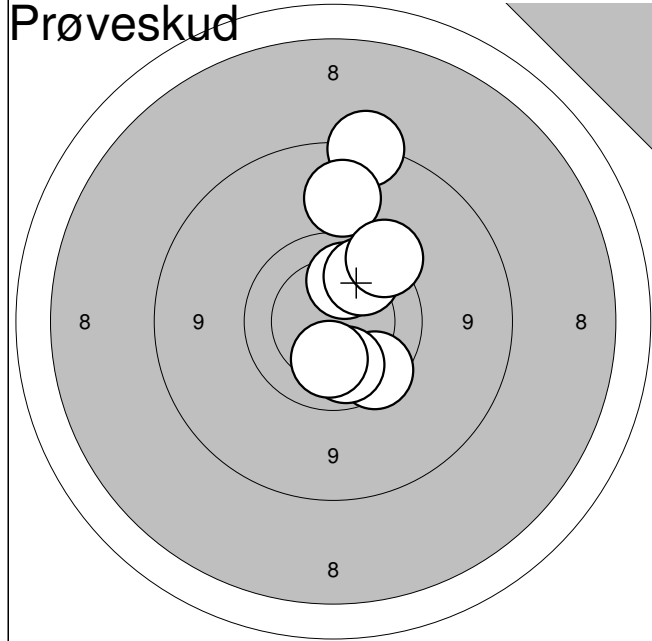

1:	8,7	↑
2:	10,1	↑
3:	9,9	↗
4:	9,1	↑
5:	9,6	↗
6:	9,8	↘
7:	10,1	↘
8:	10,2	↘

Serie:	74,0
Sum:	0,0

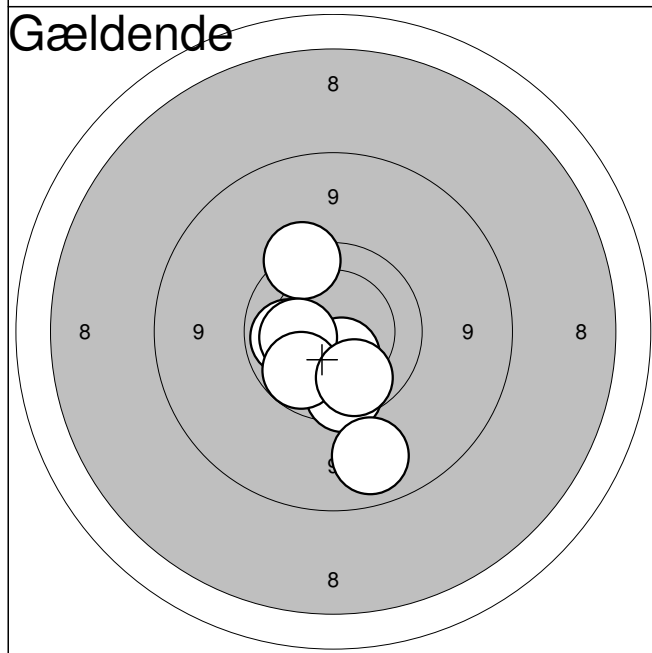

1:	9,7	↑
2:	10,2	↘
3:	9,8	↘
4:	10,3	↙
5:	9,1	↘
6:	10,4	↘
7:	10,1	↙
8:	10,3	↙
9:	10,0	↘
10:	10,0	↘

Serie:	97,0
Sum:	97,0

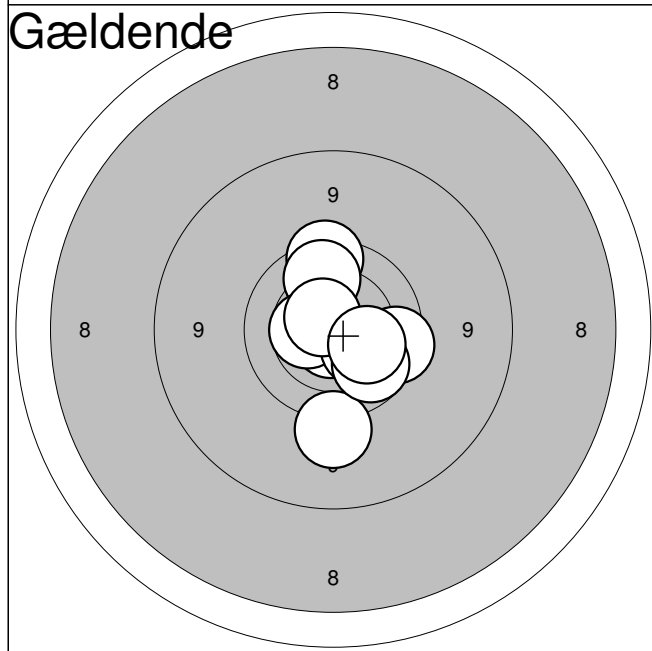

11:	10,7*	↘
12:	9,7	↑
13:	9,9	↑
14:	9,8	→
15:	10,4	↙
16:	10,3	↘
17:	10,6*	↗
18:	9,4	↘
19:	9,9	↘
20:	10,2	↘

Serie:	95,0
Sum:	192,0

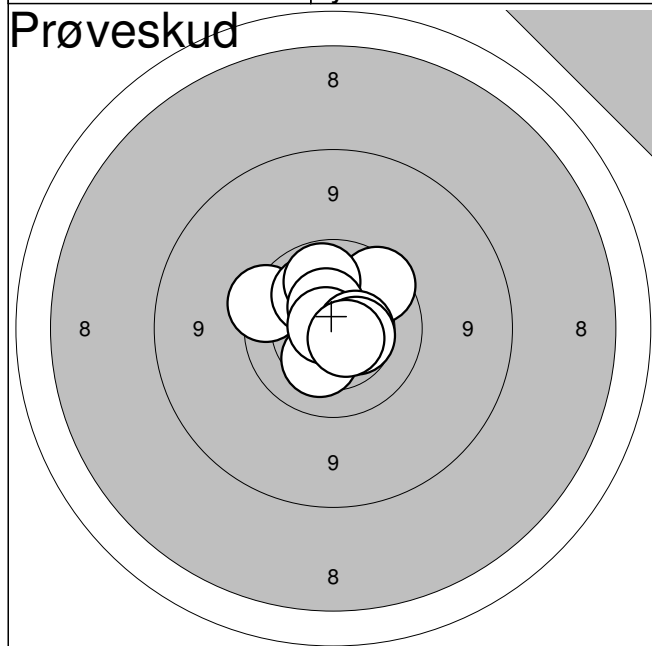

1:	9,7	↖
2:	9,8	↗
3:	10,2	↗
4:	10,0	↗
5:	10,5*	↗
6:	10,3	↘
7:	10,8*	↖
8:	10,5*	→
9:	10,5	↘
10:	10,6*	↘

Serie: 98,0

Sum: 0,0

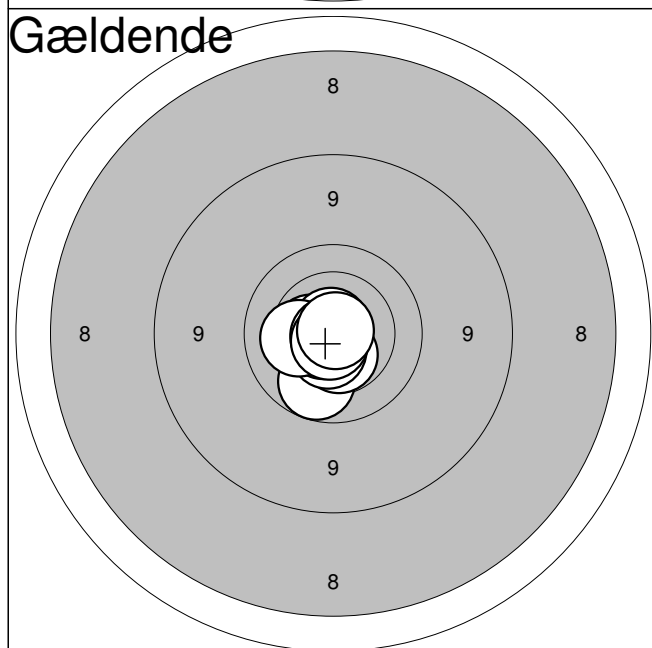

1:	10,0	↘
2:	10,5*	↘
3:	10,6*	↘
4:	10,5*	←
5:	10,8*	↑
6:	10,7*	↖
7:	10,3	←
8:	10,9*	↖
9:	10,8*	↘
10:	10,9*	↗

Serie: 100,0

Sum: 100,0

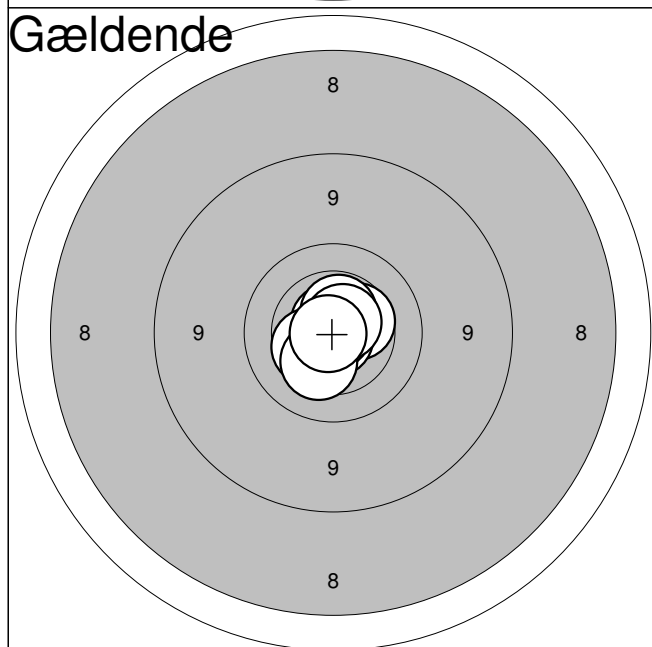

11:	10,7*	↑
12:	10,4	↘
13:	10,4	↗
14:	10,8*	↘
15:	10,9*	↑
16:	10,4	↖
17:	10,6*	↑
18:	10,3	↘
19:	10,7*	↗
20:	10,9*	←

Serie: 100,0

Sum: 200,0

Hold

59

Bane

3

Christian Gundersen

Vester Han Herred Skytteforeni

J2

Jyllandsstævne 2011 - riffel

Aalborg Skyttekreds

Prøveskud

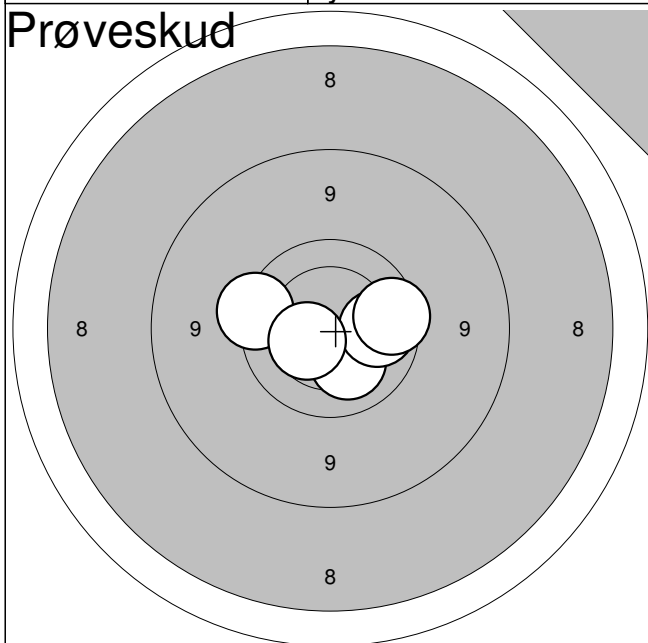

1: 9,7

←

2: 10,2

↓

3: 10,0

→

4: 9,8

→

5: 10,4

←

Serie: 48,0

Sum: 0,0

Gældende

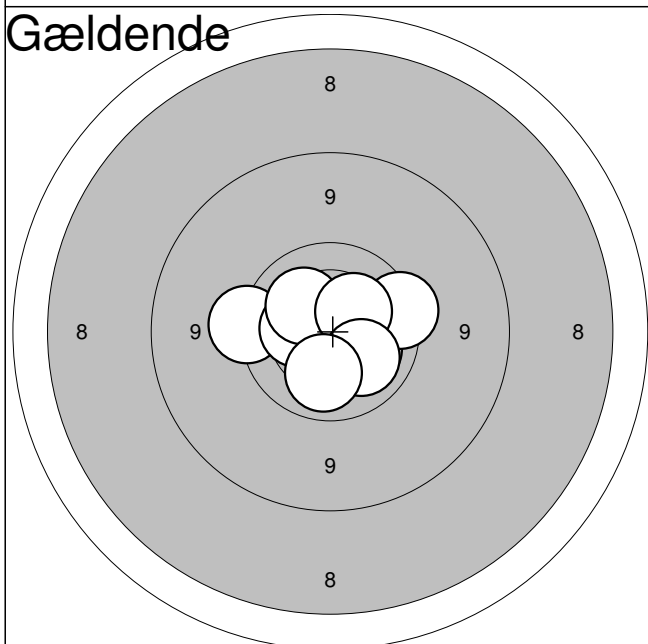

1: 10,7*

↗

2: 9,6

←

3: 10,9*

↓

4: 10,3

←

5: 10,2

↗

6: 10,2

↓

7: 9,7

→

8: 10,3

↗

9: 10,2

↓

10: 10,1

↓

Serie: 98,0

Sum: 98,0

Gældende

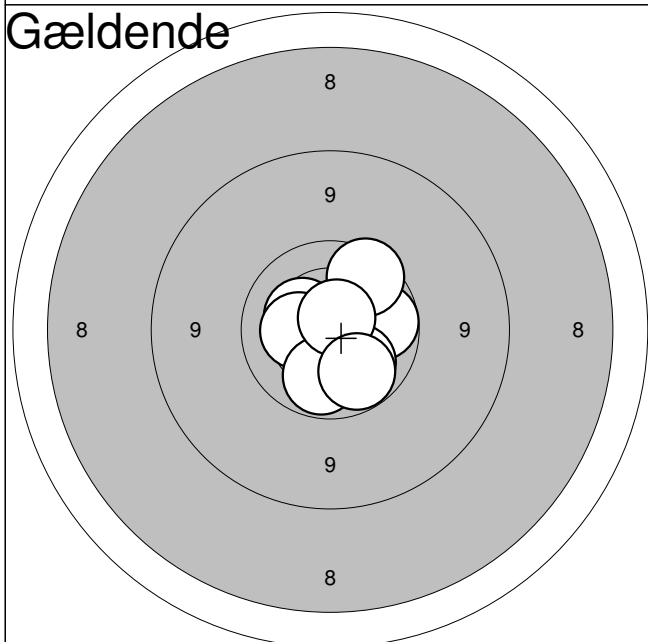

11: 10,4

↗

12: 10,2

↓

13: 10,0

→

14: 10,6*

↓

15: 10,3

←

16: 9,8

↗

17: 10,1

↓

18: 10,0

↓

19: 10,7*

↗

20: 10,0

↓

Serie: 99,0

Sum: 197,0

Jyllandsstævne 2011

Hold

Bane

59

4

Marcus K. Andersen

Vester Han Herred Skytteforeni

J2

Jyllandsstævne 2011 - riffel

Aalborg Skyttekreds

Prøveskud

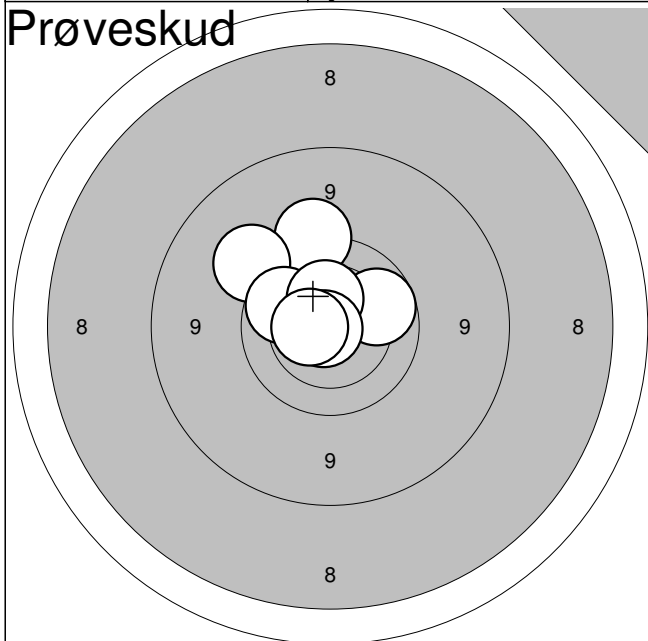

1: 9,5

↑

2: 9,4

↗

3: 10,0

→

4: 10,0

↖

5: 10,4

↑

6: 10,8*

↖

7: 10,6*

↖

Serie: 68,0

Sum: 0,0

Gældende

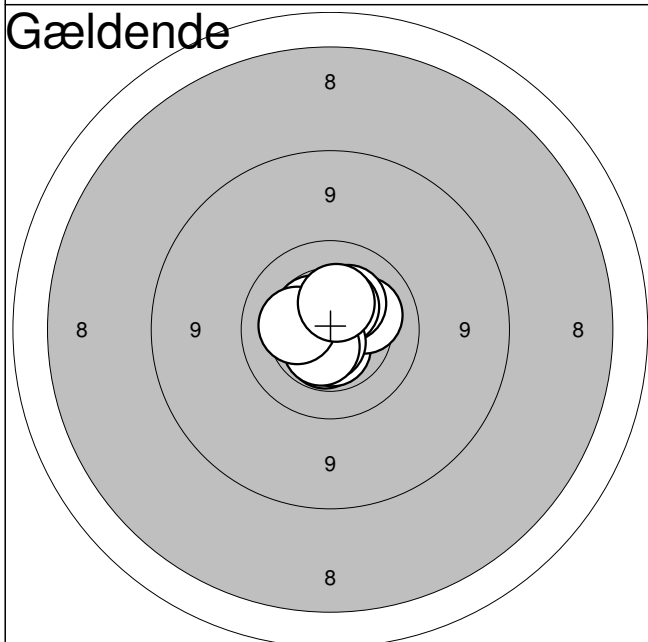

1: 10,5*

↓

2: 10,6*

↓

3: 10,5*

↗

4: 10,2

→

5: 10,3

↗

6: 10,5

↗

7: 10,7*

↓

8: 10,6*

↓

9: 10,3

↖

10: 10,4

↑

Serie: 100,0

Sum: 100,0

Gældende

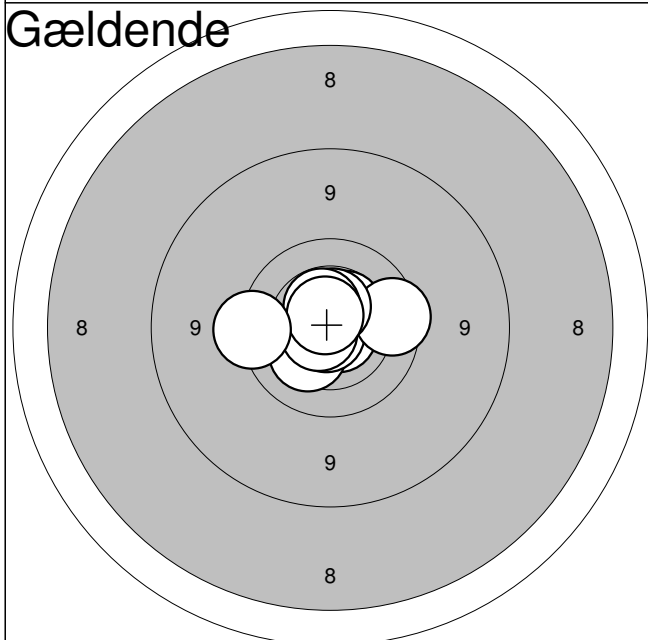

11: 10,7*

↘

12: 10,3

↘

13: 10,5

↗

14: 10,8*

↓

15: 9,8

→

16: 10,5*

↑

17: 10,5*

↑

18: 10,7*

↖

19: 10,7*

↑

20: 9,7

↖

Serie: 98,0

Sum: 198,0

Jyllandsstævne 2011

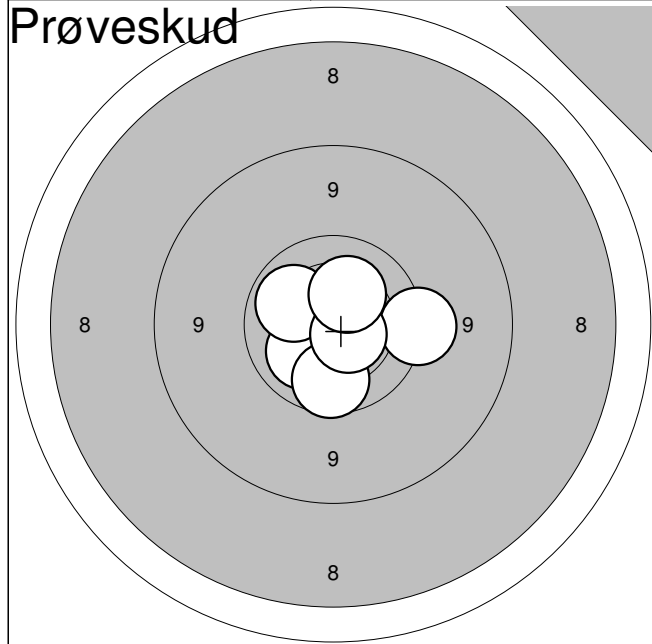

1:	9,6	→
2:	10,2	↙
3:	9,9	↓
4:	10,1	↗
5:	10,6*	↘
6:	10,3	↑

Serie:	58,0
Sum:	0,0

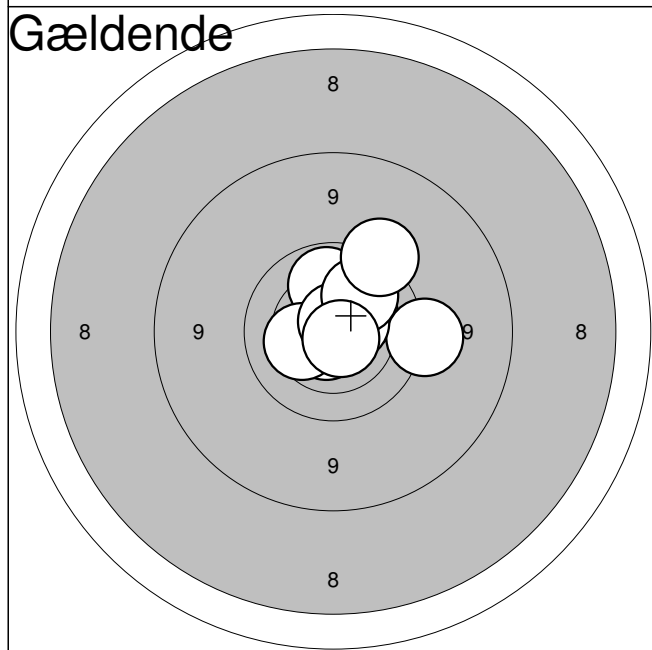

1:	10,7*	↙
2:	10,3	↗
3:	9,5	→
4:	10,6*	↗
5:	10,0	↑
6:	10,3	←
7:	10,7*	↑
8:	10,1	↗
9:	10,7*	↘
10:	9,5	↗

Serie:	98,0
Sum:	98,0

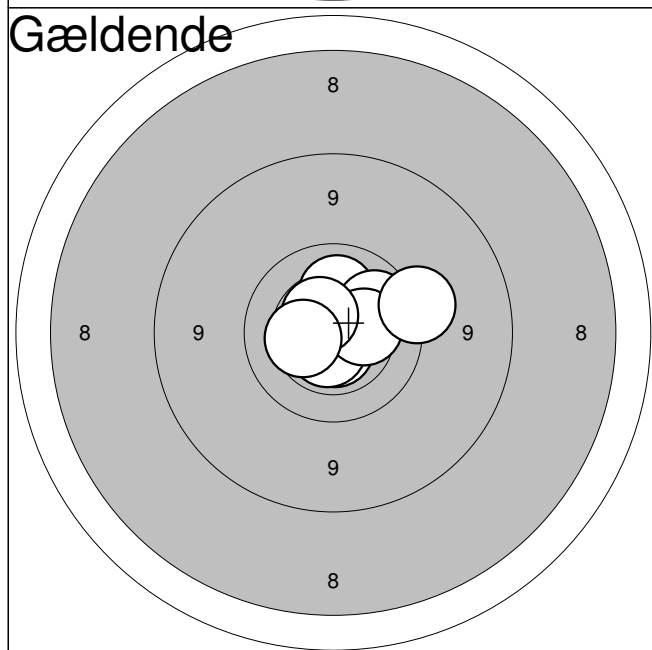

11:	10,3	↗
12:	10,6*	↓
13:	10,6*	↓
14:	10,6*	↑
15:	10,2	↑
16:	10,0	↗
17:	10,3	→
18:	10,5*	↗
19:	10,4	←
20:	9,5	→

Serie:	99,0
Sum:	197,0

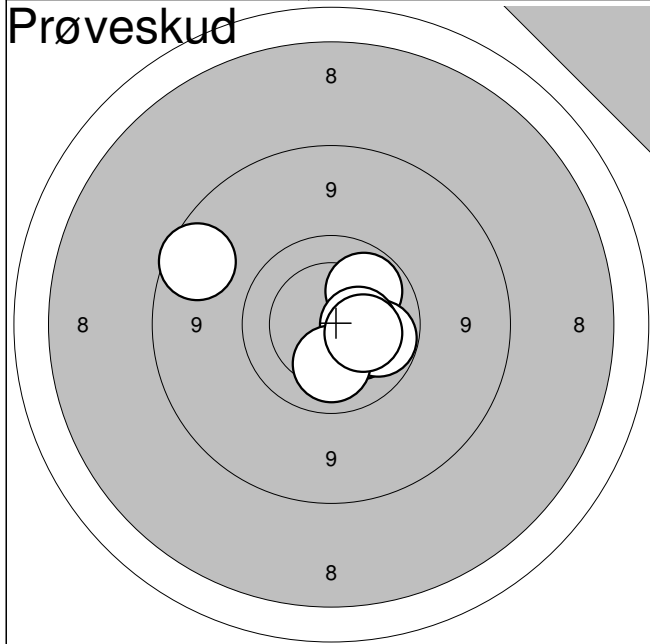

1:	8,9	↖
2:	10,3	↘
3:	10,0	↗
4:	10,0	↘
5:	10,4	→
6:	10,2	↓
7:	10,3	↘

Serie: 68,0

Sum: 0,0

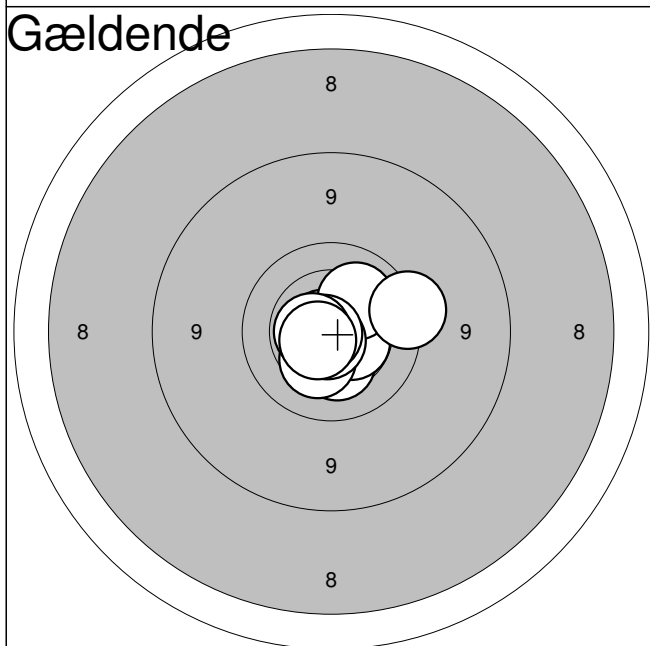

1:	10,3	↓
2:	10,8*	↖
3:	10,5*	↘
4:	10,2	↗
5:	9,6	→
6:	10,3	↓
7:	10,8*	↓
8:	10,8*	←
9:	10,6*	←
10:	10,6*	↘

Serie: 99,0

Sum: 99,0

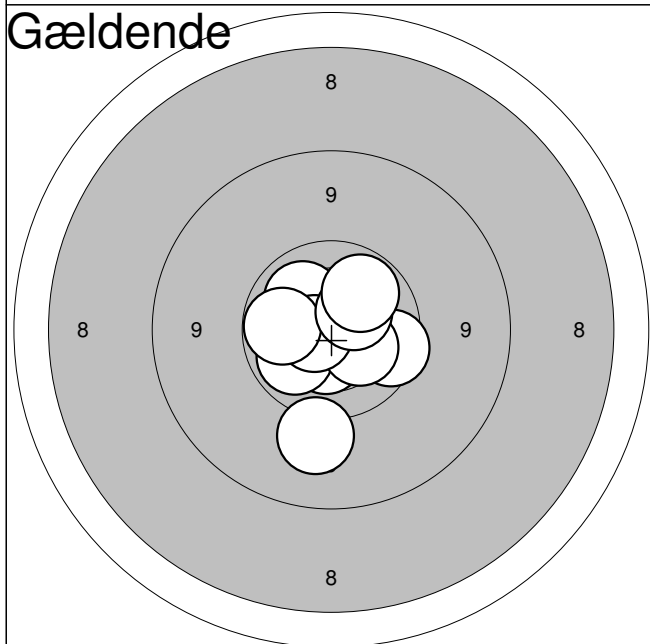

11:	10,4	↓
12:	10,1	↗
13:	10,1	↖
14:	9,8	↘
15:	10,3	↘
16:	10,6*	←
17:	10,0	←
18:	9,3	↓
19:	10,4	↗
20:	10,0	↗

Serie: 98,0

Sum: 197,0

Hold
59

Bane
7

Kasper Albrechtsen

Vester Han Herred Skytteforeni

BK3

Jyllandsstævne 2011 - riffel

Aalborg Skyttekreds

Prøveskud

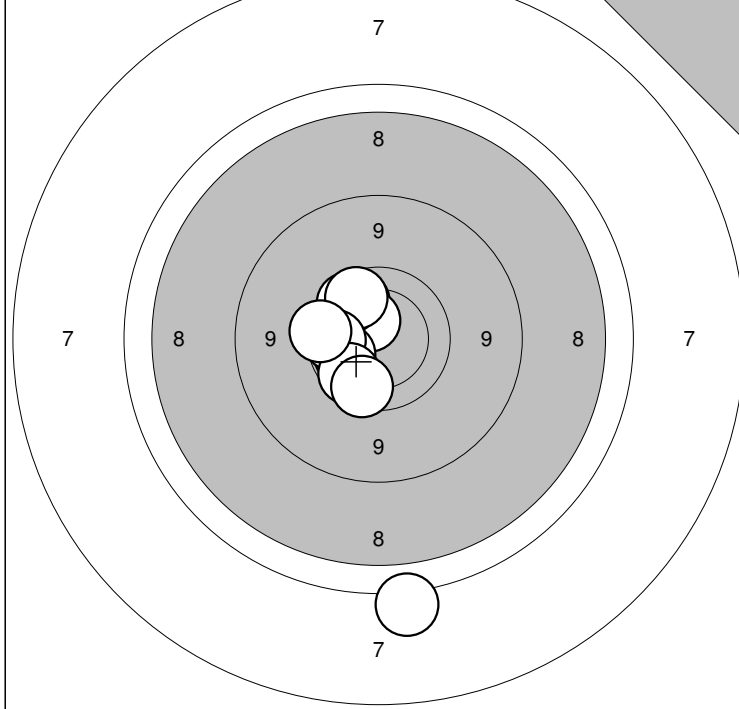

Prøveskud

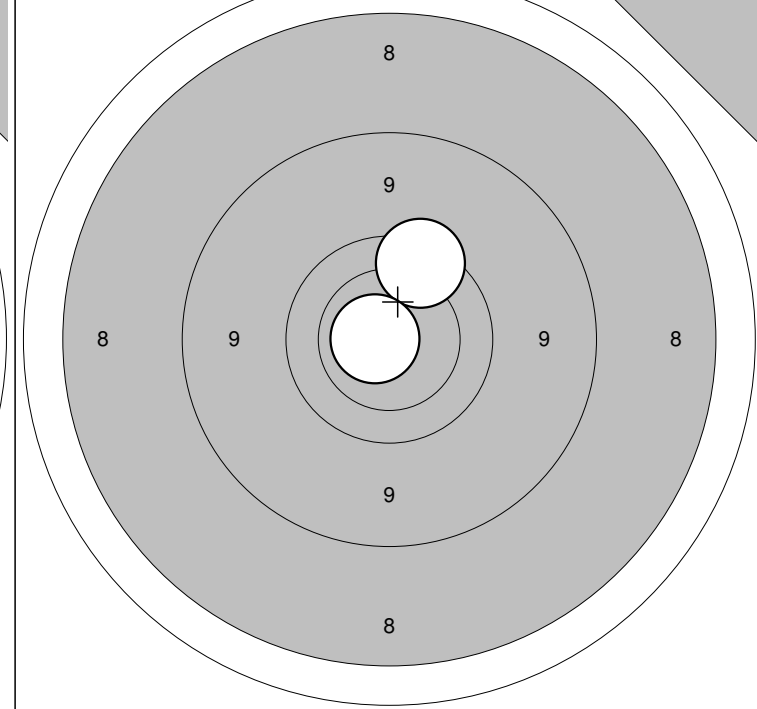

1: 7,6 ↓
2: 9,9 ↗
3: 10,5 ↗
4: 9,9 ↗
5: 9,9 ↗

6: 10,0 ←
7: 9,9 ←
8: 9,9 ↘
9: 9,8 ↓
10: 9,7 ←

Serie: 90,0
Sum: 0,0

11: 9,7 ↗
12: 10,7* ←

Serie: 19,0
Sum: 0,0

Gældende

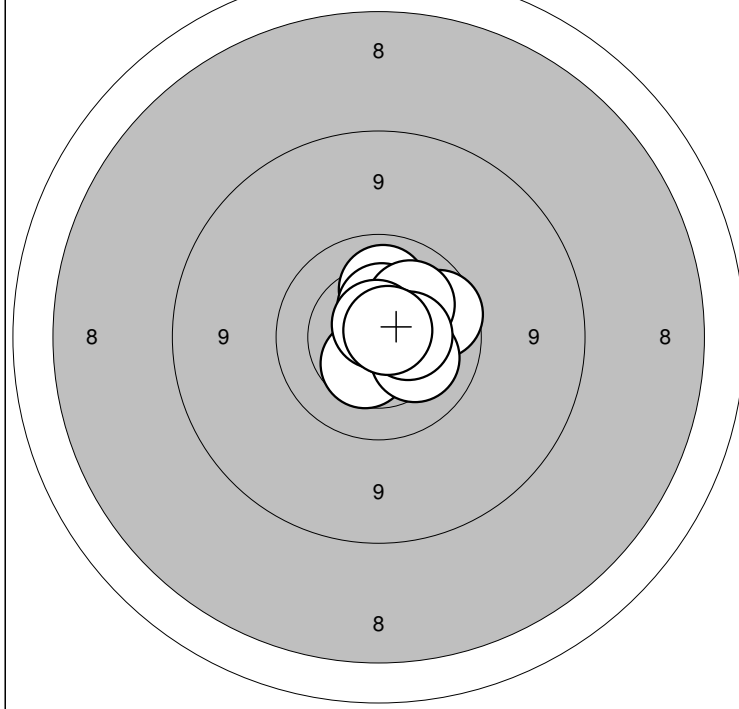

Gældende

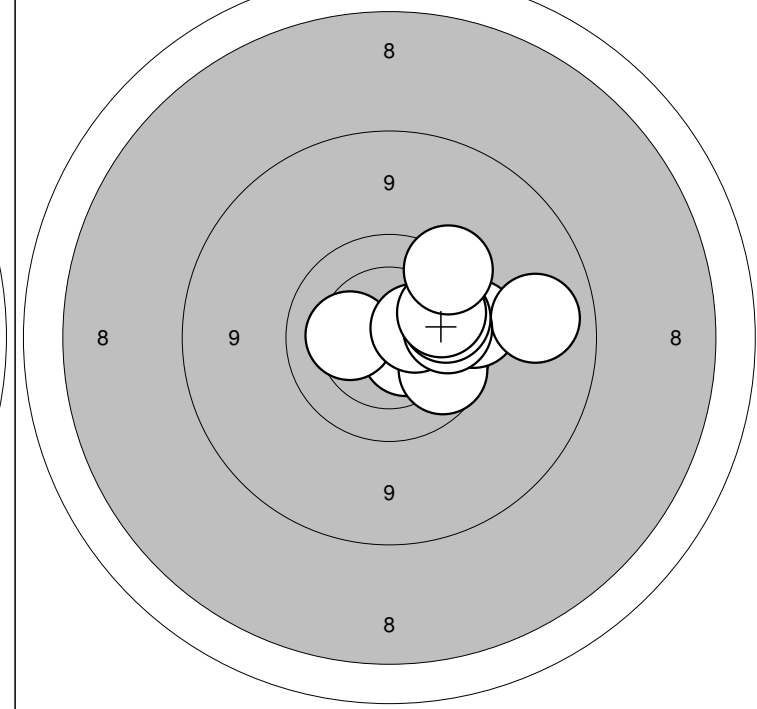

1: 10,1 ↑
2: 10,4 ↓
3: 9,9 →
4: 10,5 ↑
5: 10,2 ↗

6: 10,7* →
7: 10,7* ↑
8: 10,2 ↘
9: 10,4 →
10: 10,8* ↗

Serie: 99,0
Sum: 99,0

11: 10,6* ↘
12: 9,9 ↘
13: 9,7 →
14: 10,3 ←
15: 9,1 →

16: 10,5 →
17: 9,9 →
18: 9,9 →
19: 10,0 →
20: 9,7 ↗

Serie: 94,0
Sum: 193,0

Hold

59

Bane

8

Winnie Therkildsen

D.F.B. Aalborg

V1

Jyllandsstævne 2011 - riffel

Aalborg Skyttekreds

Prøveskud

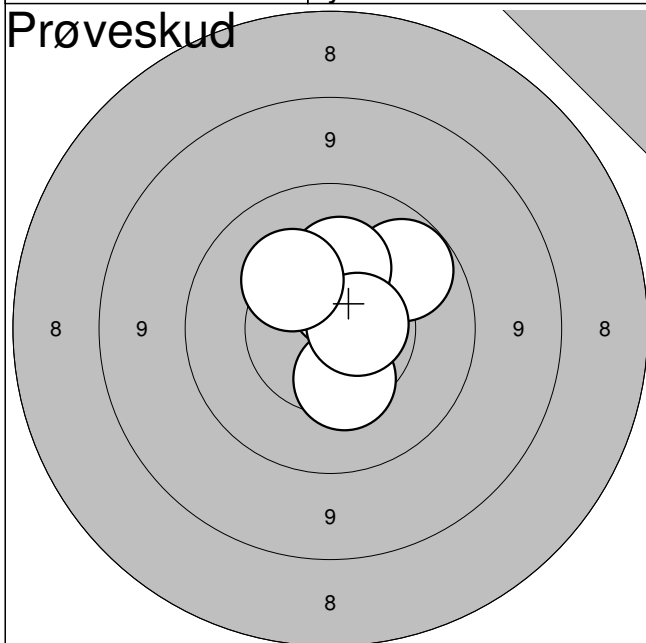

1:	10,4	↓
2:	10,5	↗
3:	10,0	↗
4:	10,6*	↑
5:	10,3	↑
6:	10,7*	→
7:	10,3	↖

Serie: 70,0

Sum: 0,0

Gældende

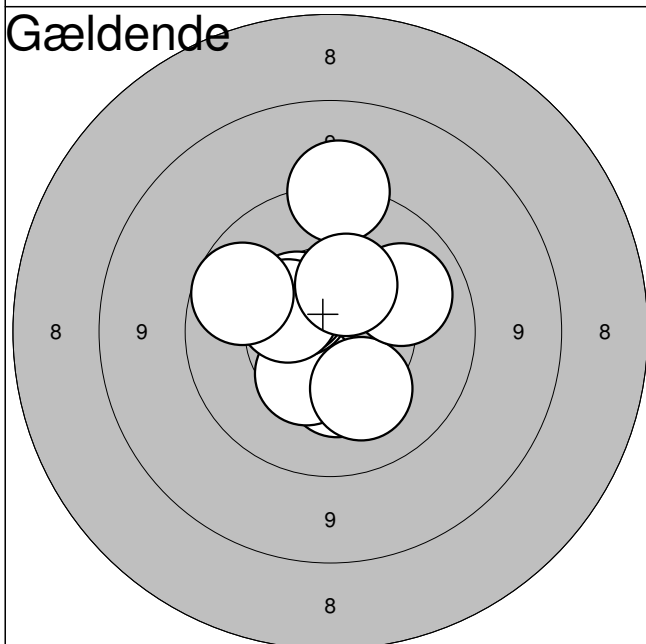

1:	10,4	↓
2:	10,4	↓
3:	10,5	↗
4:	10,3	↓
5:	10,5	↗
6:	10,1	→
7:	9,4	↑
8:	10,5	↖
9:	9,9	↖
10:	10,4	↑

Serie: 98,0

Sum: 98,0

Gældende

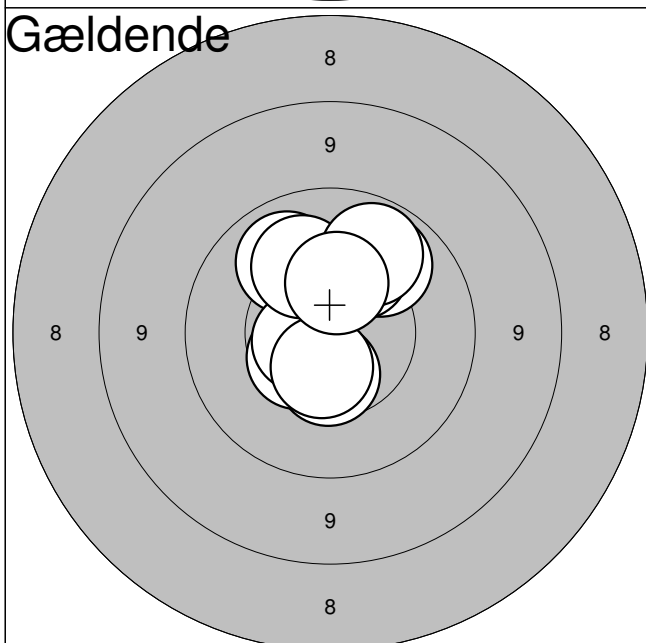

11:	10,5	↓
12:	10,5	↖
13:	10,1	↖
14:	10,1	↗
15:	10,2	↑
16:	10,7*	←
17:	10,2	↑
18:	10,6	↓
19:	10,0	↗
20:	10,4	↑

Serie: 100,0

Sum: 198,0

Jyllandsstævne 2011

Hold
59

Bane
9

Lise Kjær

Rostrup Skf.

ÅK3

Jyllandsstævne 2011 - riffel

Aalborg Skyttekreds

Prøveskud

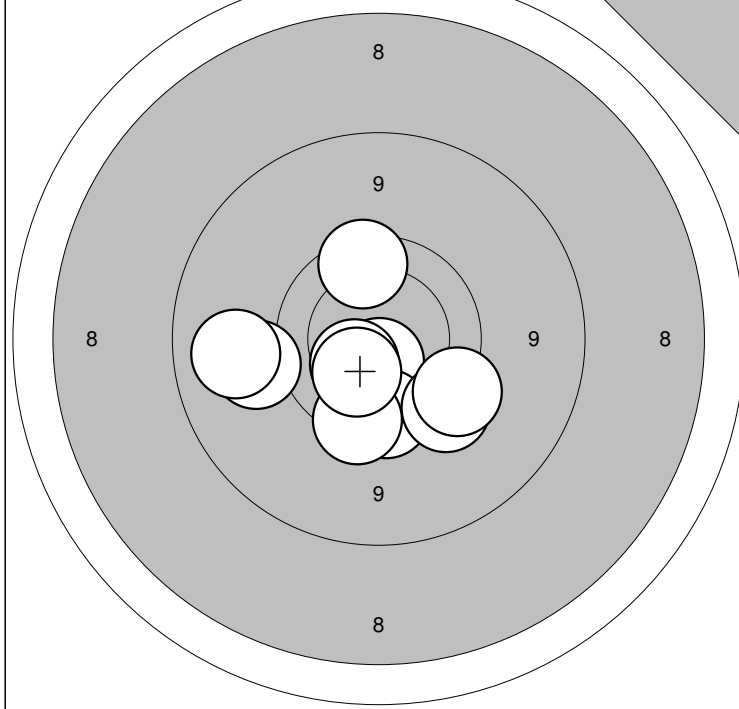

Prøveskud

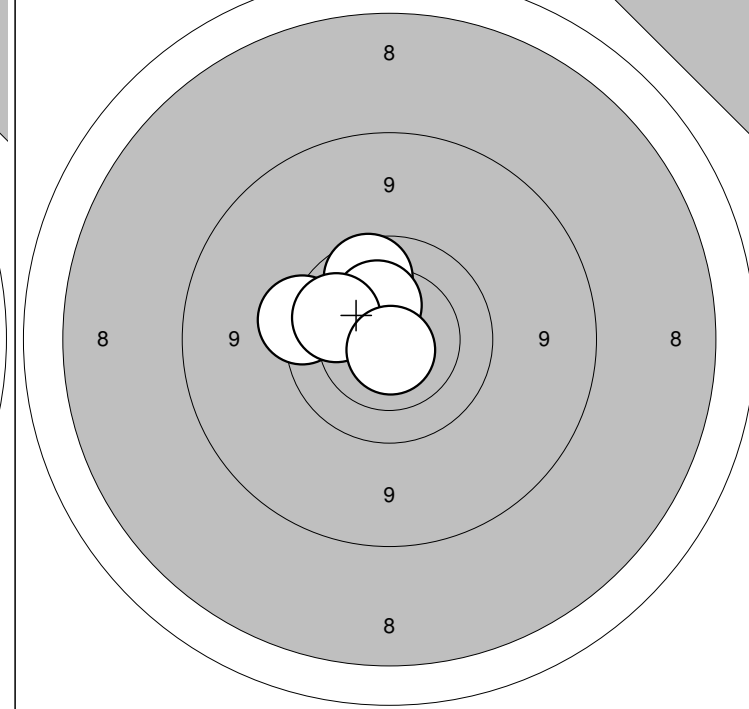

1: 9,3 ←	6: 9,6 →	Serie: 93,0
2: 10,5* ↓	7: 10,4 ↘	
3: 9,8 ↓	8: 9,1 ←	Sum: 0,0
4: 9,6 ↘	9: 10,3 ↘	
5: 9,7 ↓	10: 9,8 ↑	

11: 9,7 ←	Serie: 48,0
12: 9,9 ↑	
13: 10,3 ↑	Sum: 0,0
14: 10,0 ←	
15: 10,8* ↓	

Gældende

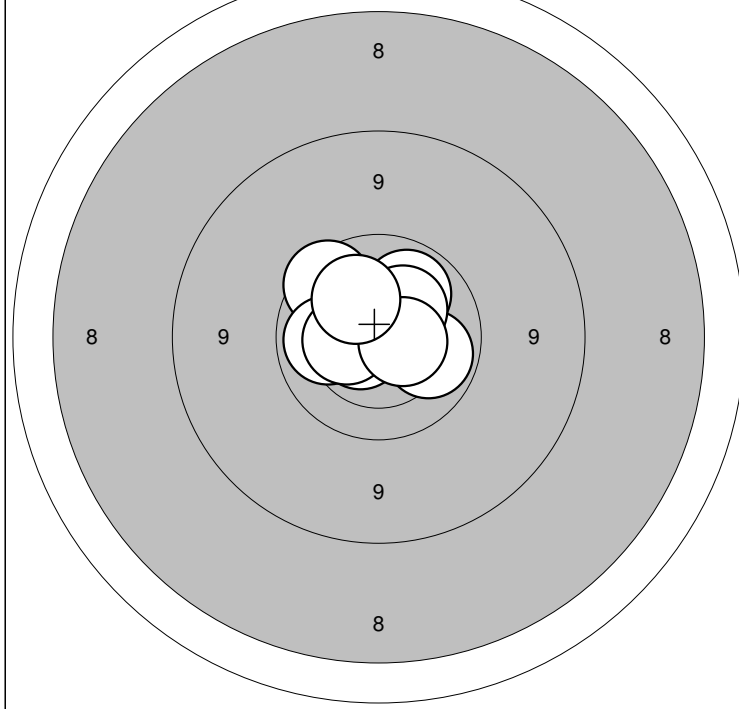

Gældende

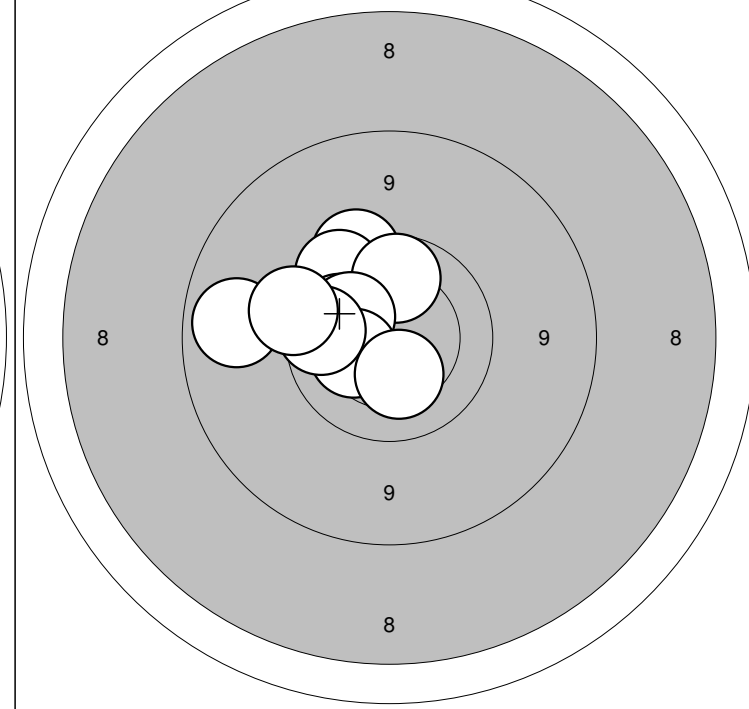

1: 10,1 ↗	6: 10,7* ↑	Serie: 99,0
2: 9,8 ↖	7: 10,3 ↗	
3: 10,1 →	8: 10,4 ←	Sum: 99,0
4: 10,6* ←	9: 10,5* →	
5: 10,1 ←	10: 10,2 ↗	

11: 9,7 ↑	16: 9,0 ←	Serie: 94,0
12: 9,7 ↗	17: 10,3 ←	
13: 9,9 ↑	18: 9,9 ←	Sum: 193,0
14: 10,1 ←	19: 10,3 ↓	
15: 10,2 ↗	20: 9,6 ←	

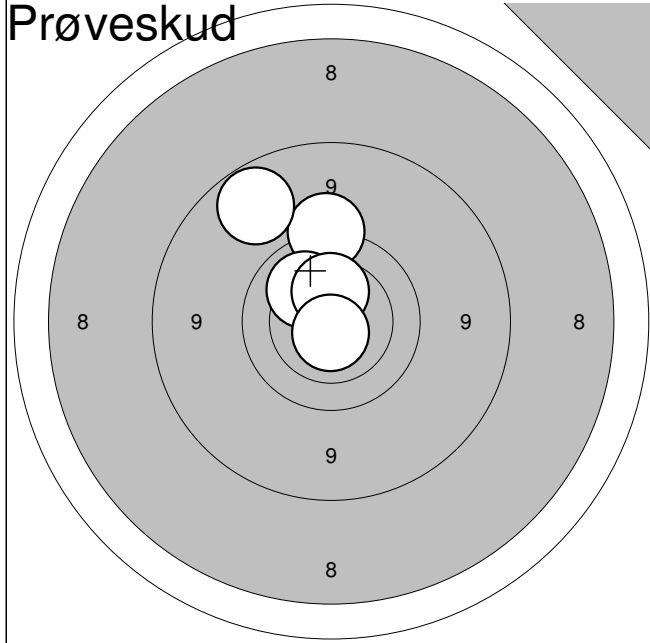

1:	9,5	↑
2:	9,0	↗
3:	10,2	↗
4:	10,4	↑
5:	10,7*	↓

Serie:	48,0
Sum:	0,0

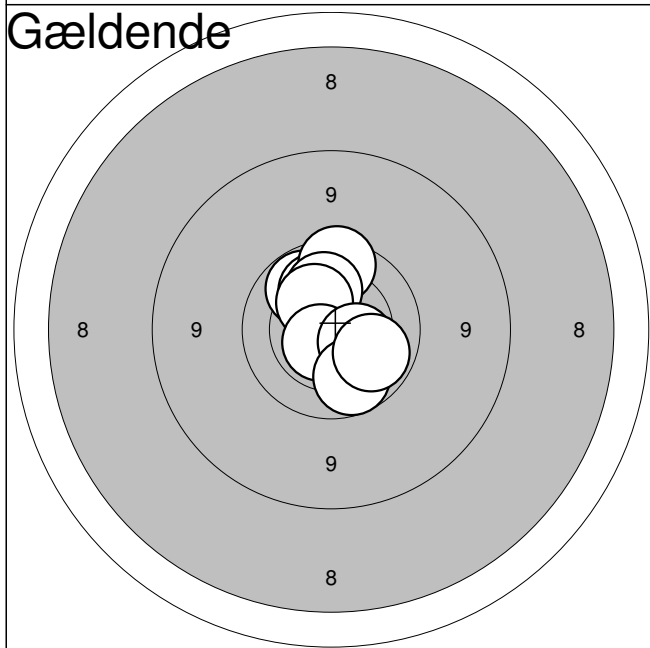

1:	10,0	↗
2:	10,2	↗
3:	9,8	↑
4:	10,2	↑
5:	10,3	↗
6:	10,1	↓
7:	10,6*	↓
8:	10,4	↓
9:	9,9	↓
10:	10,0	↓

Serie:	98,0
Sum:	98,0

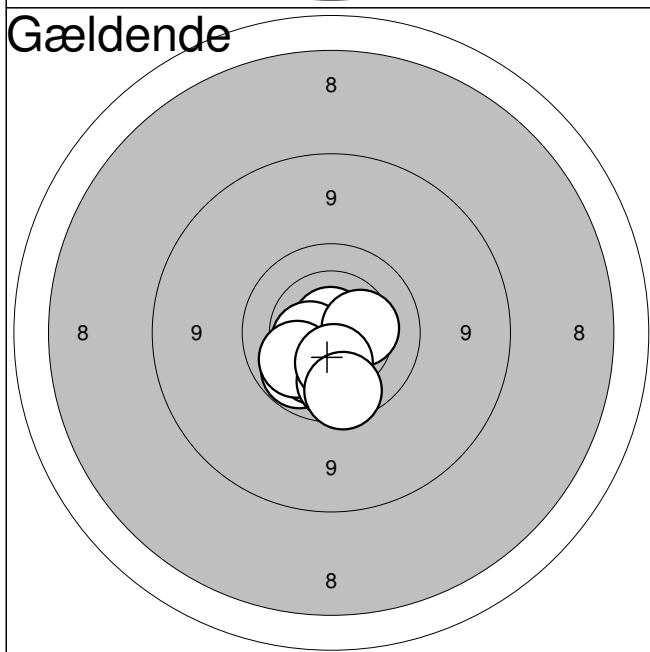

11:	10,7*	↓
12:	10,8*	↑
13:	10,0	↓
14:	10,5*	←
15:	10,2	↓
16:	10,1	↙
17:	10,4	→
18:	10,0	↓
19:	10,4	↓
20:	9,9	↓

Serie:	99,0
Sum:	197,0

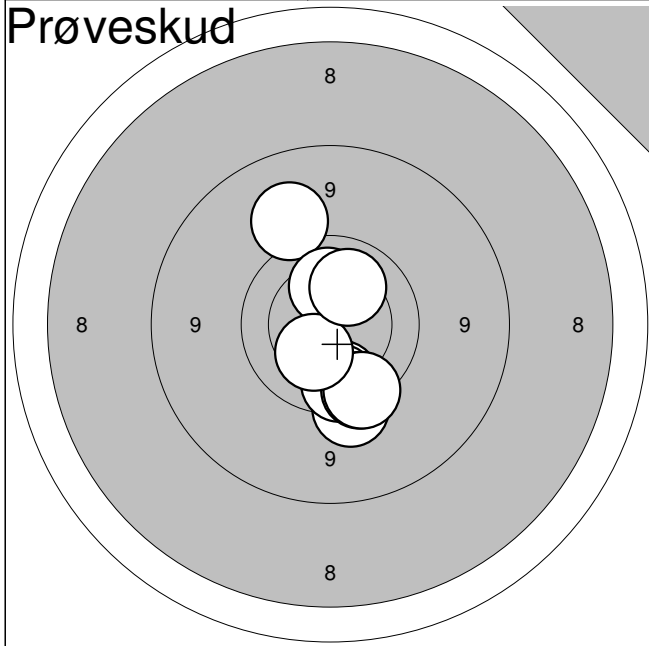

1:	9,6	↓
2:	9,3	↗
3:	10,2	↑
4:	9,9	↓
5:	9,9	↓
6:	9,7	↓
7:	9,7	↓
8:	10,3	↘
9:	10,2	↗

Serie:	84,0
Sum:	0,0

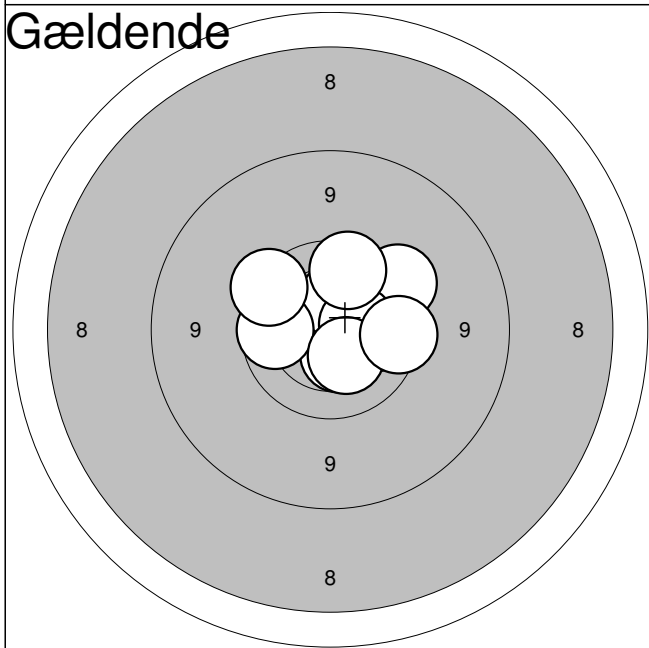

1:	10,4	↓
2:	10,4	↑
3:	9,9	←
4:	10,0	→
5:	9,6	↗
6:	10,4	→
7:	10,4	↓
8:	9,7	↗
9:	9,8	↑
10:	9,8	→

Serie:	95,0
Sum:	95,0

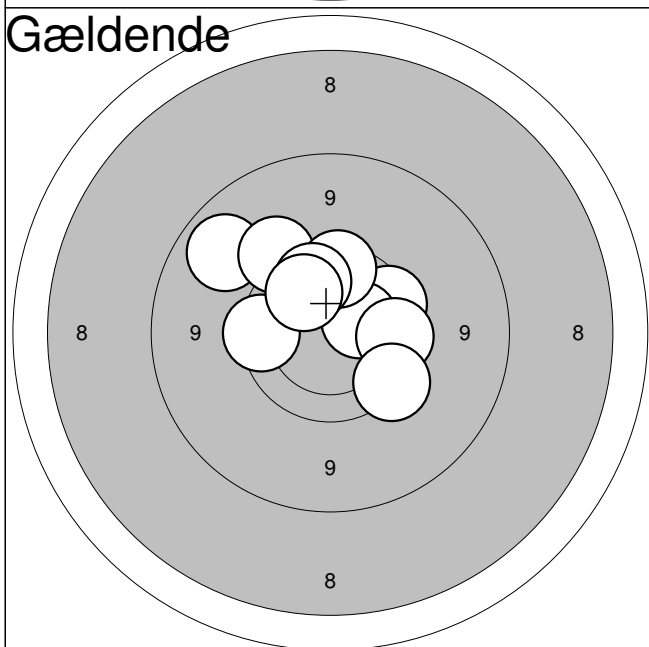

11:	9,8	←
12:	9,8	→
13:	9,1	↗
14:	9,5	↗
15:	10,3	→
16:	9,8	↑
17:	9,9	↑
18:	10,0	↗
19:	9,8	→
20:	9,6	↘

Serie:	92,0
Sum:	187,0

Fræer og Omegns Skf.

H1

Jyllandsstævne 2011 - riffel

Aalborg Skyttekreds

Prøveskud

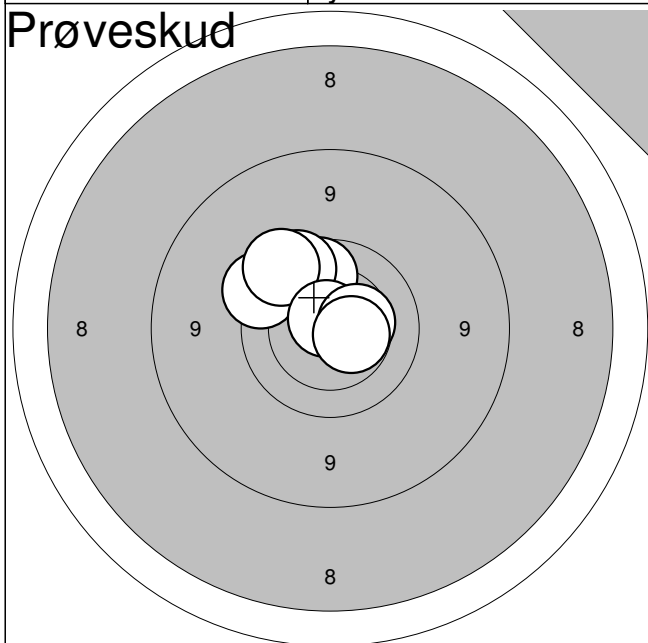

1:	9,9	↗
2:	9,8	↗
3:	9,6	↗
4:	9,7	↗
5:	10,8*	↗
6:	10,4	→
7:	10,5*	↘

Serie: 66,0

Sum: 0,0

Gældende

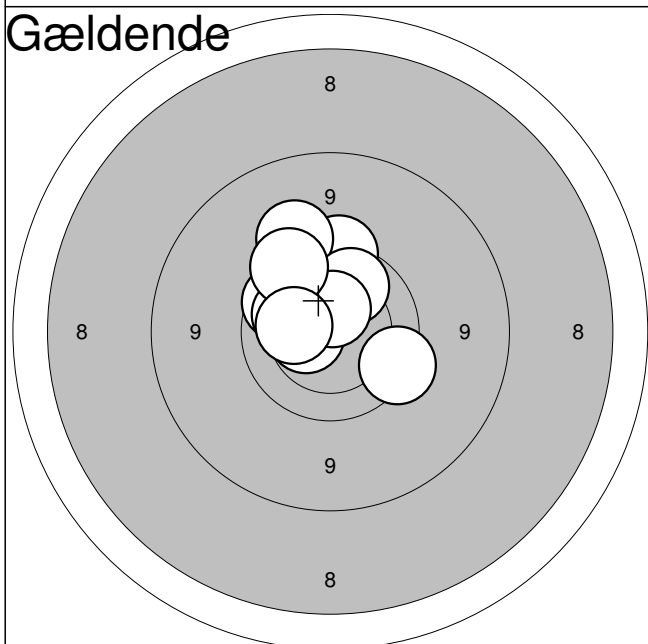

1:	9,7	↘
2:	9,7	↑
3:	9,9	↗
4:	10,1	↖
5:	9,4	↑
6:	10,0	↑
7:	10,5	←
8:	10,5*	↑
9:	9,7	↗
10:	10,2	←

Serie: 95,0

Sum: 95,0

Gældende

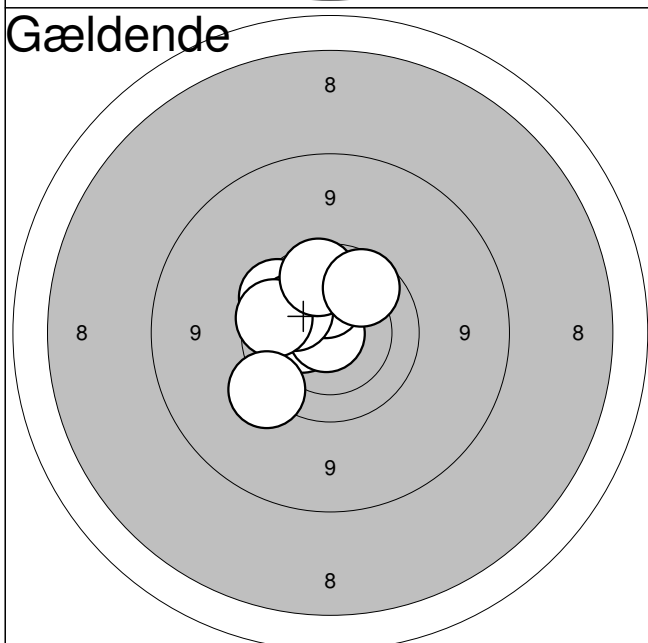

11:	10,4	←
12:	10,9*	←
13:	9,9	↗
14:	10,3	↑
15:	9,8	↗
16:	10,2	↗
17:	9,9	←
18:	9,9	↑
19:	9,9	↗
20:	9,6	↘

Serie: 94,0

Sum: 189,0

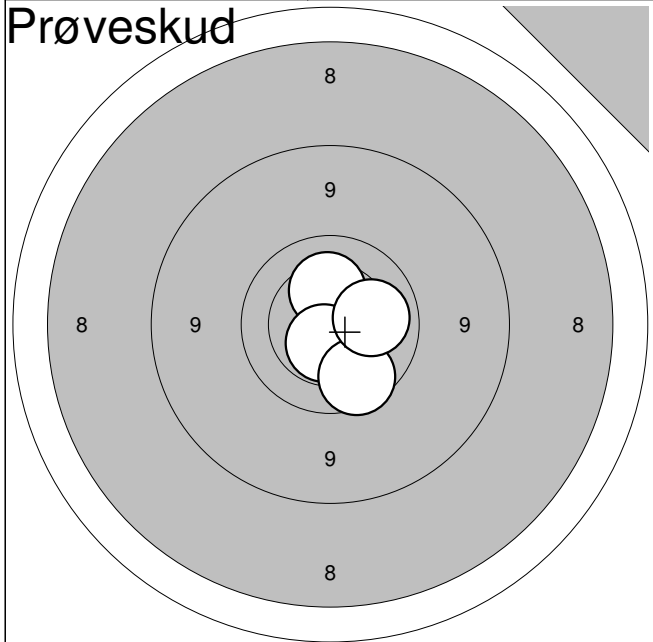

1:	10,3	↑
2:	10,6*	↓
3:	9,9	↓
4:	10,1	→

Serie:	39,0
Sum:	0,0

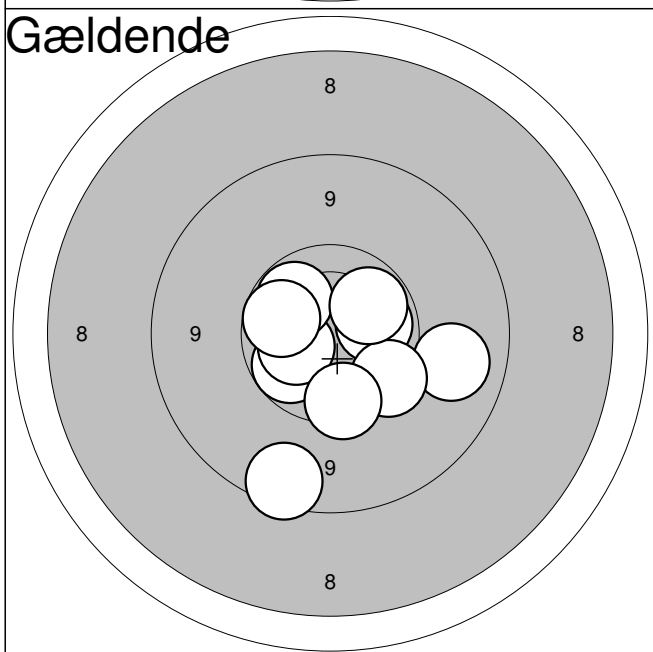

1:	10,0	↙
2:	8,8	↓
3:	10,2	↙
4:	9,1	→
5:	10,1	→
6:	10,0	↗
7:	9,7	↓
8:	9,8	↓
9:	10,0	↗
10:	10,0	↙

Serie:	95,0
Sum:	95,0

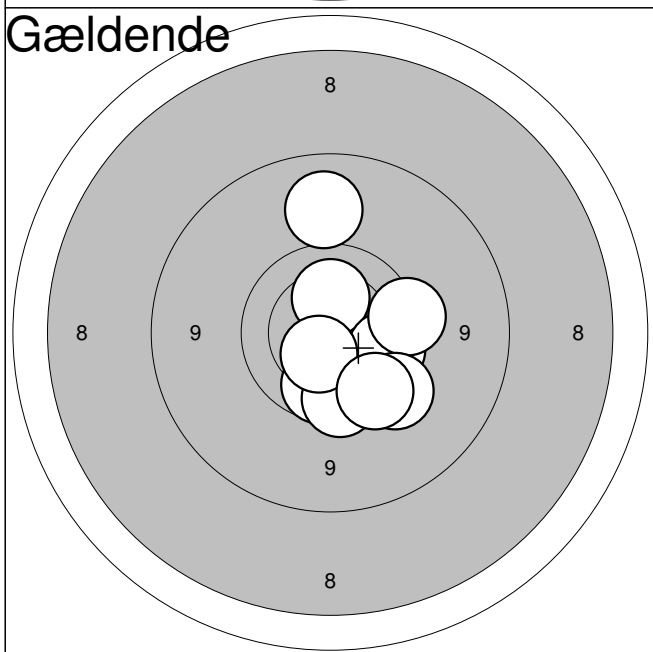

11:	10,3	↑
12:	9,6	↓
13:	9,9	↓
14:	9,9	→
15:	9,6	→
16:	9,8	↓
17:	9,1	↑
18:	9,5	↓
19:	10,5	↓
20:	9,7	↓

Serie:	92,0
Sum:	187,0

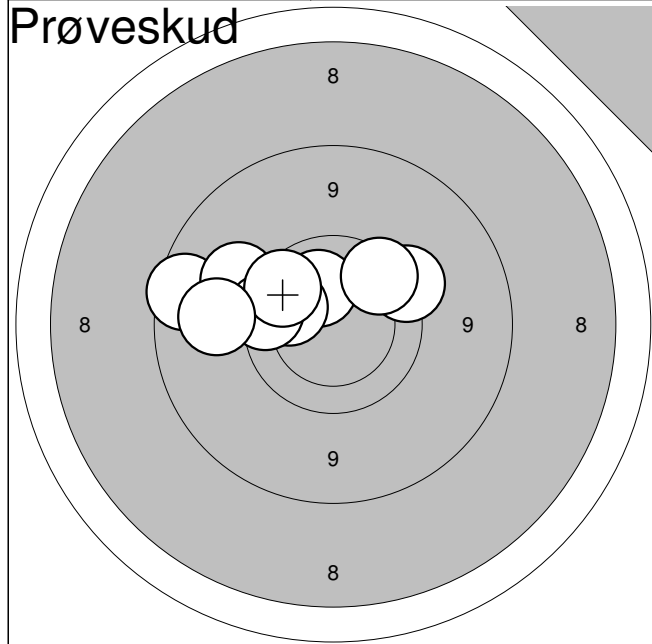

1:	9,6	↗
2:	10,2	↑
3:	9,8	↗
4:	8,9	↖
5:	9,4	↖
6:	9,4	↗
7:	10,0	↗
8:	9,8	↖
9:	9,8	↗
10:	9,2	↖

Serie: 91,0

Sum: 0,0

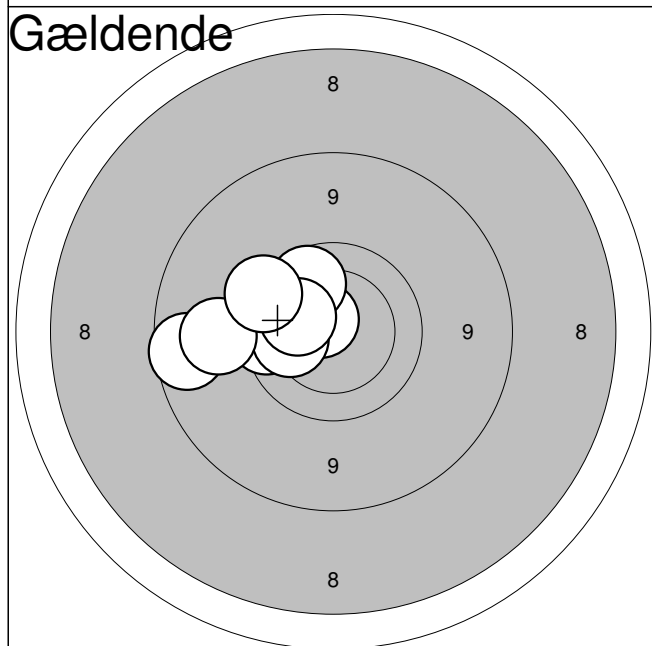

1:	10,3	↗
2:	10,3	↗
3:	10,6*	↗
4:	8,9	↖
5:	9,8	↖
6:	9,9	↗
7:	10,1	↖
8:	10,2	↗
9:	9,2	↖
10:	9,6	↗

Serie: 94,0

Sum: 94,0

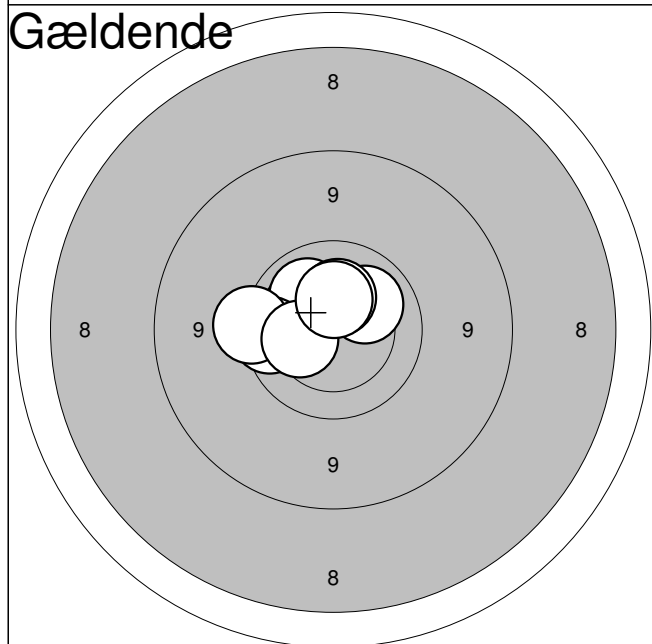

11:	10,2	↗
12:	10,4	↗
13:	10,3	↗
14:	10,1	↗
15:	9,8	↖
16:	10,2	↗
17:	9,6	↖
18:	10,3	↖
19:	10,3	↑
20:	10,4	↑

Serie: 98,0

Sum: 192,0

Hold

60

Bane

3

Marcus K. Andersen

Vester Han Herred Skytteforeni

J2

Jyllandsstævne 2011 - riffel

Aalborg Skyttekreds

Prøveskud

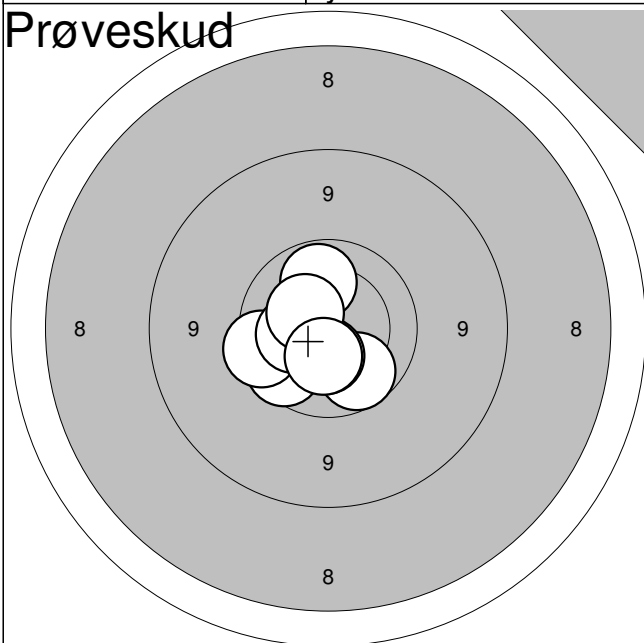

1: 9,9



2: 10,3



3: 9,9



4: 10,4



5: 9,7



6: 10,3



7: 10,0



8: 10,4



9: 10,4



Serie:

87,0

Sum:

0,0

Gældende

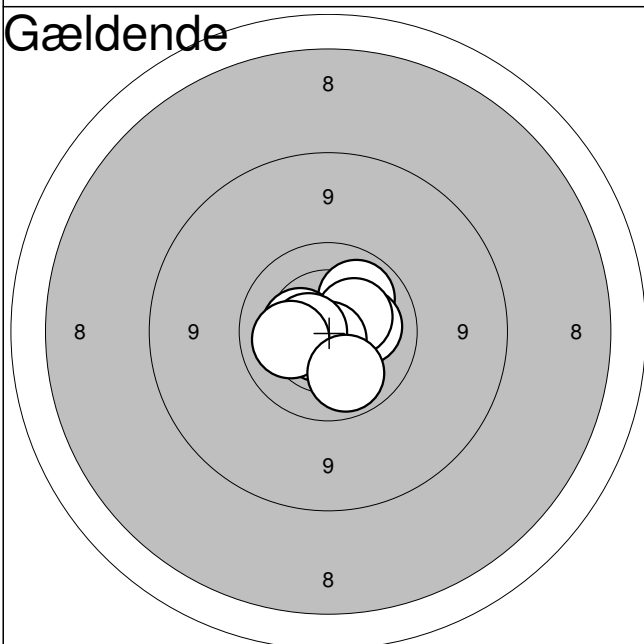

1: 10,9*



2: 10,1



3: 10,7*



4: 10,4



5: 10,2



6: 10,4



7: 10,8*



8: 10,6*



9: 10,2



10: 10,1



Serie:

100,0

Sum:

100,0

Gældende

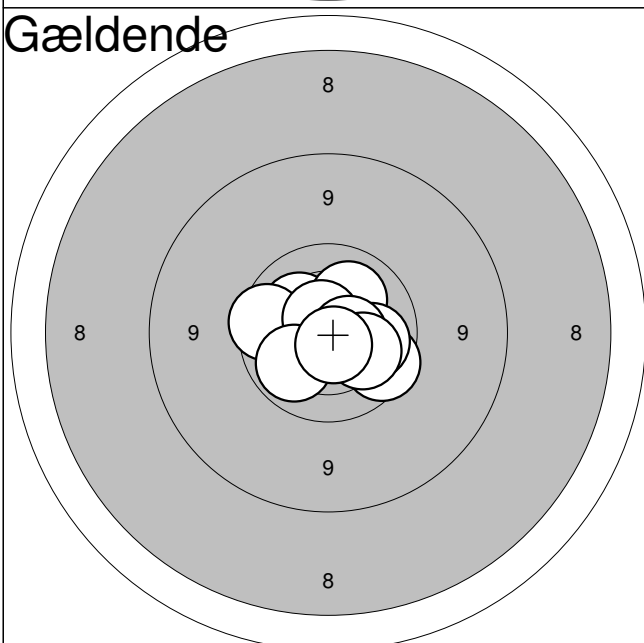

11: 10,3



12: 9,8



13: 9,8



14: 10,2



15: 10,1



16: 10,6*



17: 10,1



18: 10,5*



19: 10,2



20: 10,7*



Serie:

98,0

Sum:

198,0

Jyllandsstævne 2011

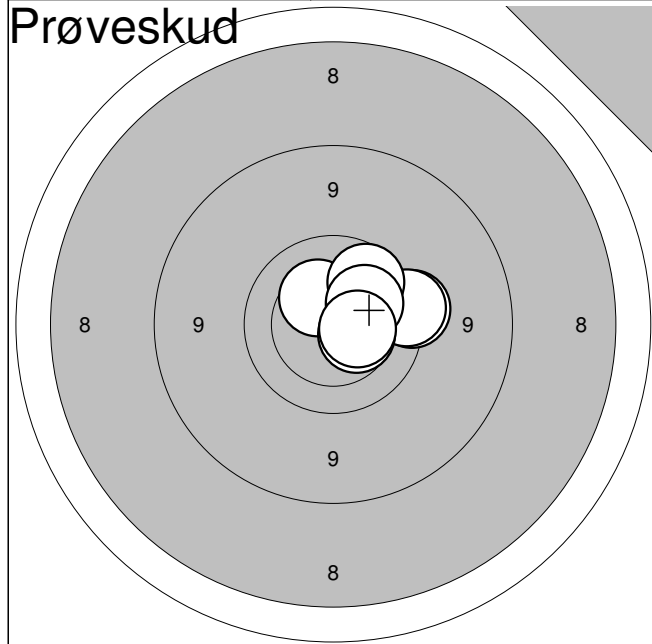

1:	10,4	↗
2:	9,6	→
3:	9,7	→
4:	10,4	↘
5:	9,9	↗
6:	10,2	↗
7:	10,5	→

Serie:	67,0
Sum:	0,0

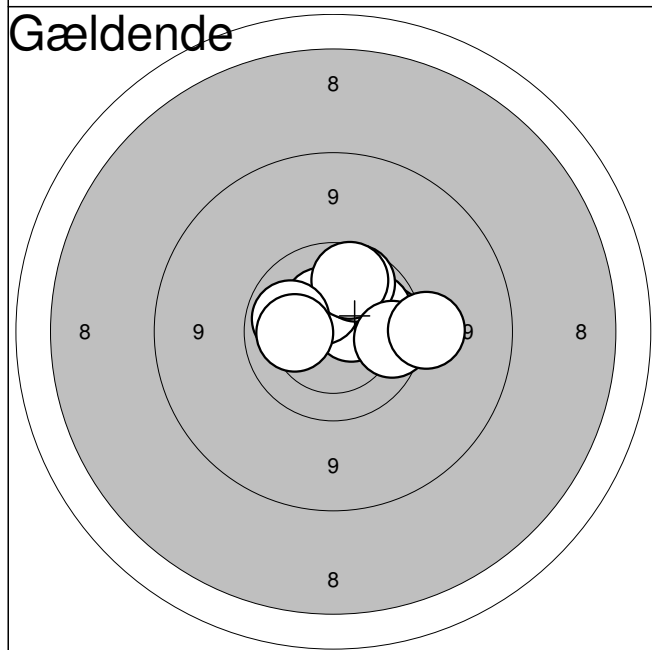

1:	9,9	→
2:	10,1	↗
3:	10,6*	↗
4:	10,4	↖
5:	9,9	↗
6:	9,9	↖
7:	9,8	→
8:	10,1	←
9:	10,2	←
10:	9,5	→

Serie:	95,0
Sum:	95,0

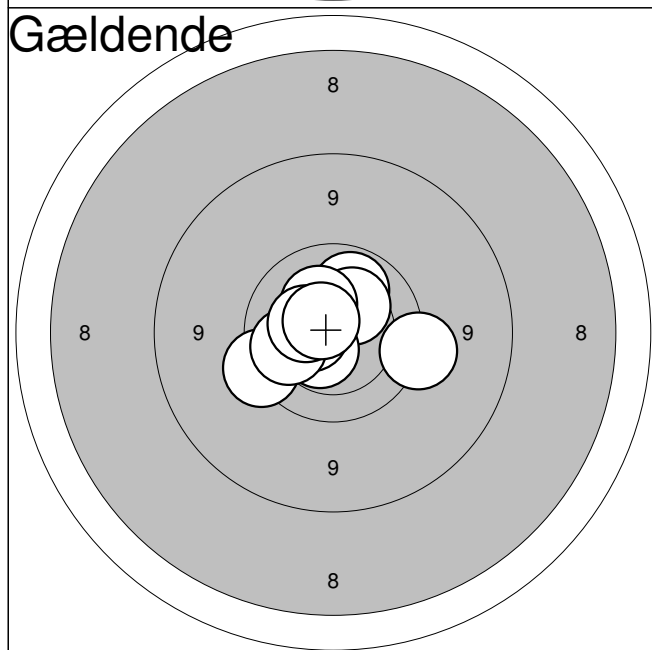

11:	10,1	↖
12:	10,3	↖
13:	10,5*	↘
14:	10,3	↖
15:	10,5*	←
16:	9,5	→
17:	9,6	←
18:	10,0	←
19:	10,4	←
20:	10,6*	↖

Serie:	98,0
Sum:	193,0

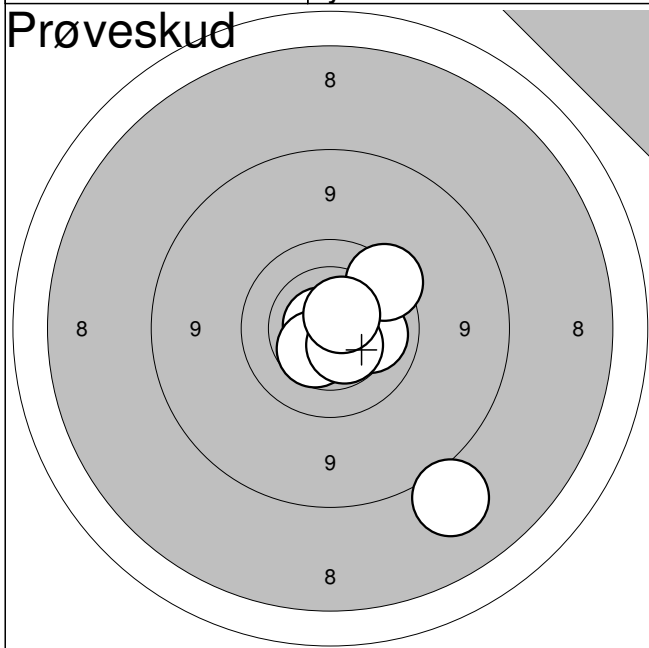

1:	10,8*	↖
2:	10,5	↘
3:	8,5	↘
4:	10,2	→
5:	9,7	↗
6:	10,5*	↘
7:	10,6*	↗

Serie:	67,0
---------------	-------------

Sum:	0,0
-------------	------------

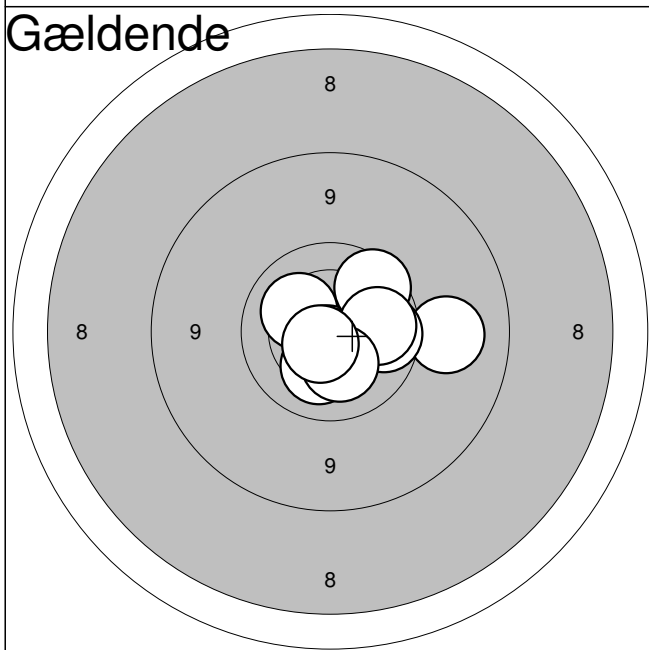

1:	10,2	↘
2:	10,2	↗
3:	9,2	→
4:	10,7*	↘
5:	9,9	→
6:	10,6*	↘
7:	9,8	↗
8:	10,0	→
9:	10,3	↘
10:	10,6*	↘

Serie:	97,0
---------------	-------------

Sum:	97,0
-------------	-------------

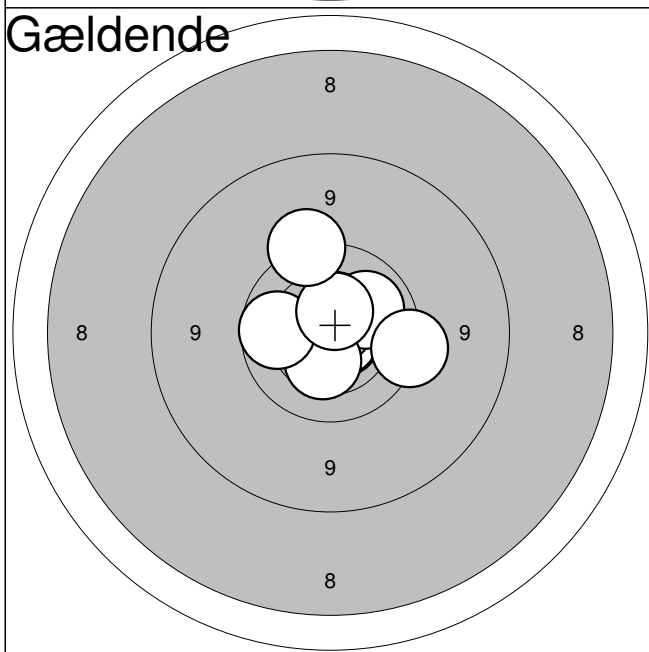

11:	10,7*	↘
12:	10,7*	↘
13:	10,8*	↗
14:	10,1	↗
15:	10,6*	↖
16:	10,4	↘
17:	9,9	↖
18:	9,6	→
19:	10,5*	↗
20:	9,5	↗

Serie:	97,0
---------------	-------------

Sum:	194,0
-------------	--------------

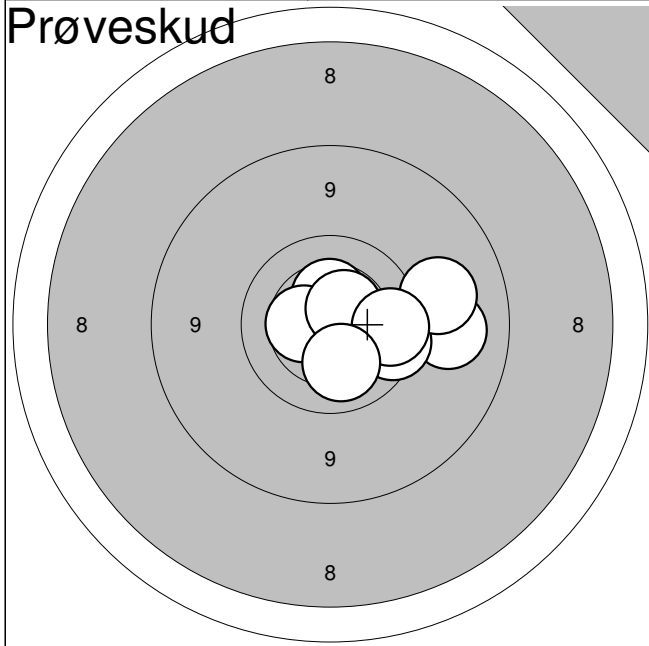

1:	10,4	↑
2:	9,2	→
3:	10,7*	↓
4:	10,6*	↗
5:	9,8	→
6:	10,4	←
7:	9,3	→
8:	10,5*	↗
9:	9,8	→
10:	10,2	↓

Serie: 96,0

Sum: 0,0

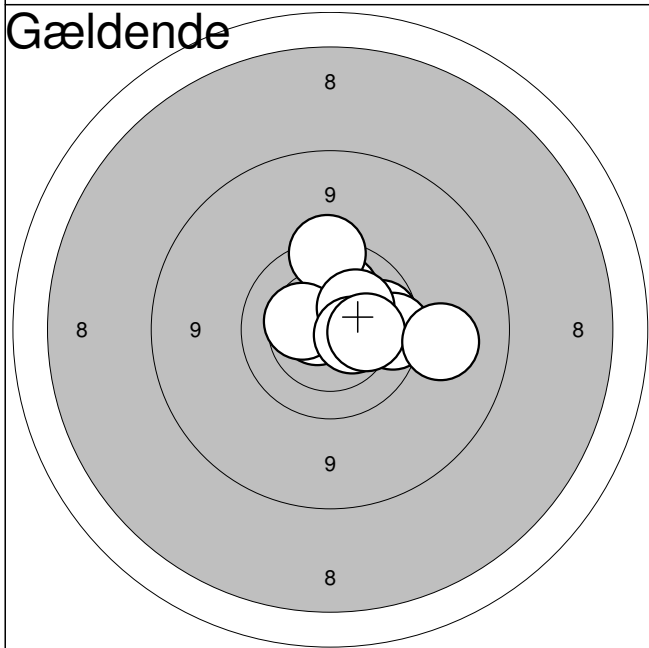

1:	9,9	→
2:	10,7*	←
3:	10,2	↑
4:	9,8	→
5:	9,7	↑
6:	10,4	←
7:	10,3	↗
8:	10,5*	→
9:	10,2	→
10:	9,3	→

Serie: 96,0

Sum: 96,0

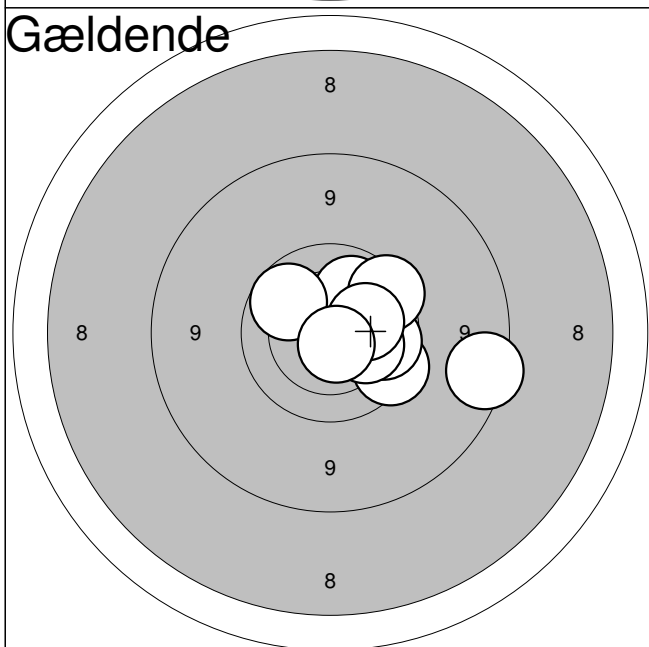

11:	9,7	↘
12:	9,9	→
13:	10,5	↗
14:	10,2	→
15:	10,1	↗
16:	9,9	↗
17:	9,8	↗
18:	10,2	→
19:	8,8	→
20:	10,7*	↓

Serie: 94,0

Sum: 190,0

Hold

60

Bane

7

Ann Olsen

Aalborg Skyttekreds

ÅK2

Jyllandsstævne 2011 - riffel

Aalborg Skyttekreds

Prøveskud

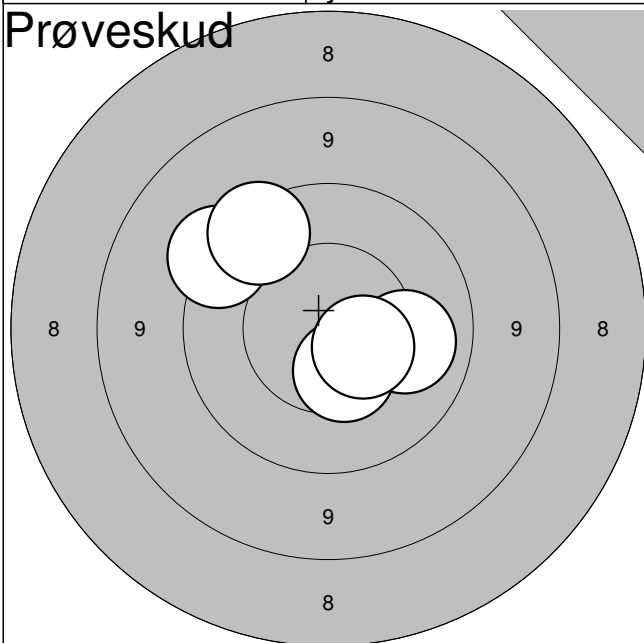

1: 9,5



2: 9,7



3: 10,1



4: 10,5



5: 10,5



Serie:

48,0

Sum:

0,0

Gældende

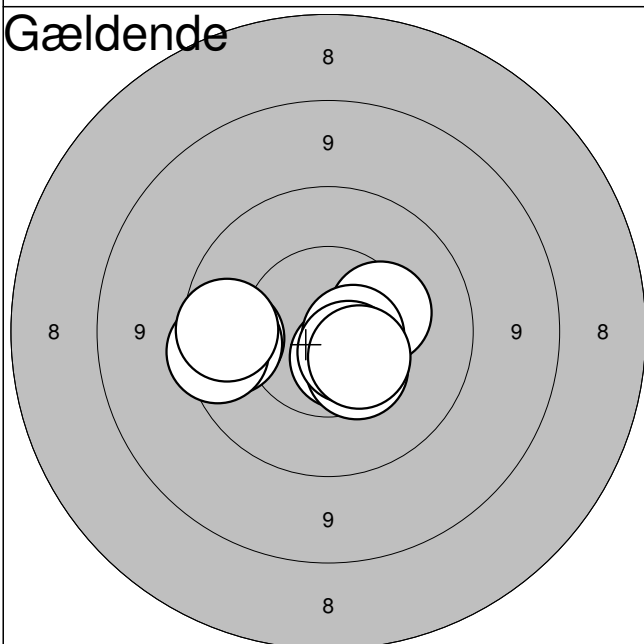

1: 10,6*



2: 9,9



3: 10,4



4: 10,5



5: 9,9



6: 9,7



7: 10,7*



8: 10,6*



9: 9,9



10: 10,5



Serie:

96,0

Sum:

96,0

Gældende

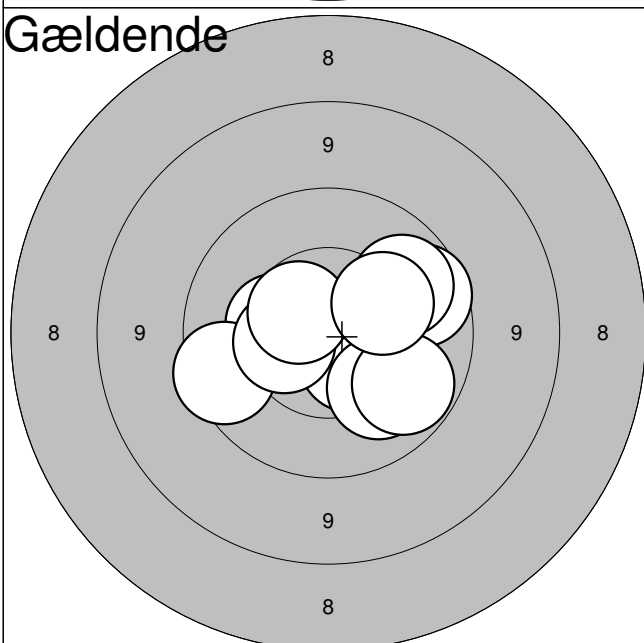

11: 10,6



12: 10,4



13: 9,8



14: 10,2



15: 9,9



16: 10,0



17: 10,5



18: 10,0



19: 10,6



20: 10,3



Serie:

98,0

Sum:

194,0

Jyllandsstævne 2011

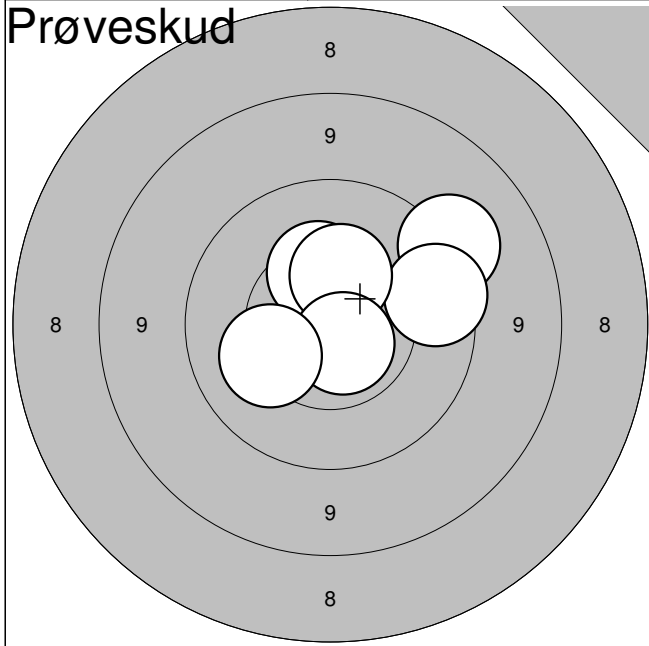

1:	9,4	↗
2:	9,8	→
3:	10,4	↑
4:	10,4	↑
5:	10,7*	↘
6:	10,2	↖

Serie: 58,0

Sum: 0,0

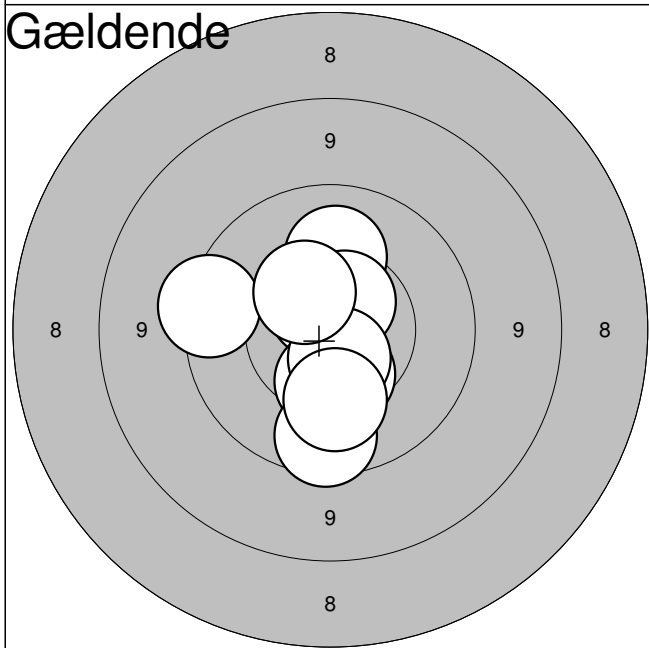

1:	10,7*	↗
2:	10,4	↘
3:	10,2	↑
4:	10,5	↘
5:	10,6*	↗
6:	10,6*	↘
7:	9,8	↘
8:	10,2	↘
9:	9,6	↖
10:	10,5	↗

Serie: 98,0

Sum: 98,0

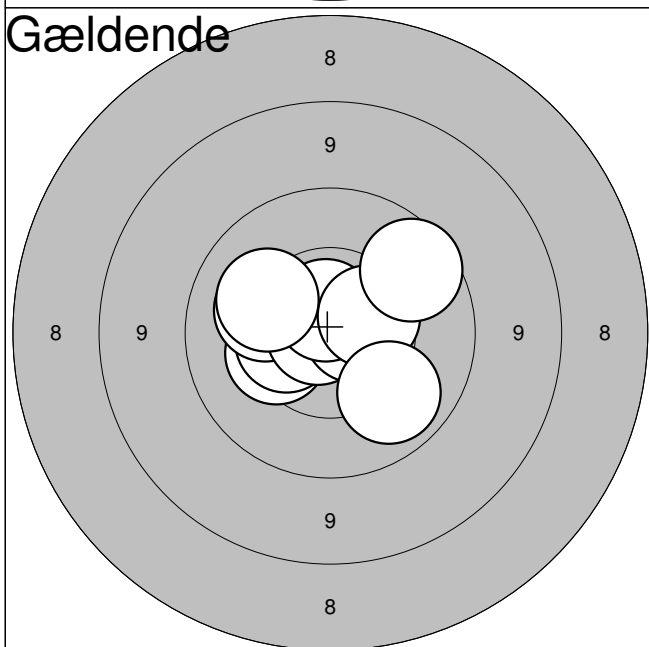

11:	10,3	↖
12:	10,5	↖
13:	10,2	↖
14:	10,8*	↖
15:	10,7*	→
16:	10,7*	↑
17:	10,5	→
18:	10,1	↘
19:	10,2	↖
20:	9,9	↗

Serie: 99,0

Sum: 197,0

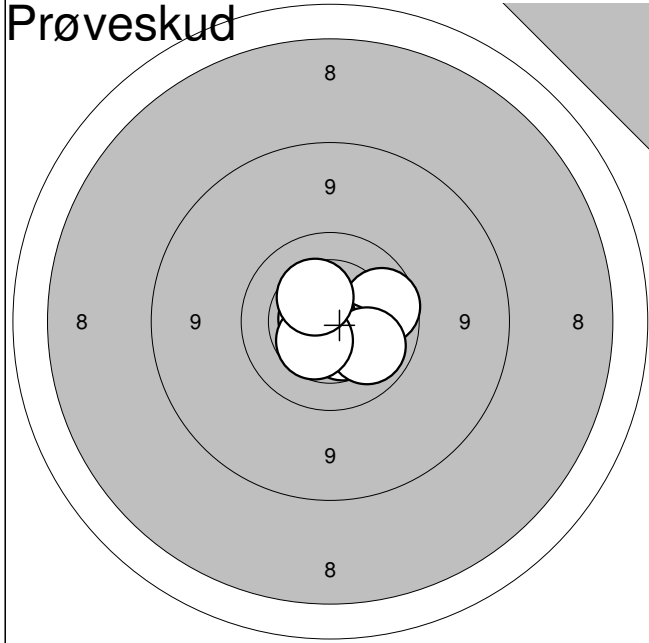

1:	9,9	→
2:	10,5	↓
3:	10,7*	←
4:	10,1	↓
5:	10,5	↓
6:	10,4	↑

Serie:	59,0
Sum:	0,0

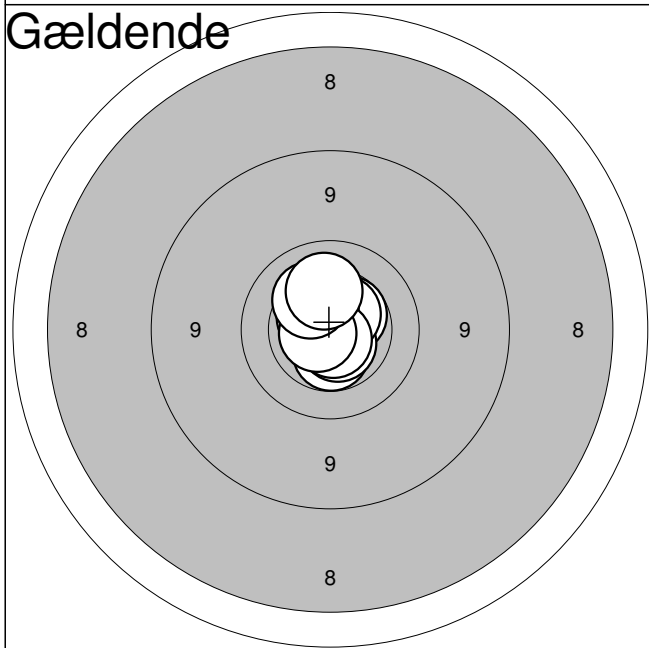

1:	10,5*	↗
2:	10,6*	↗
3:	10,5*	↓
4:	10,6*	↓
5:	10,6*	↗
6:	10,5*	↗
7:	10,7*	↓
8:	10,7*	←
9:	10,3	↗
10:	10,2	↑

Serie:	100,0
Sum:	100,0

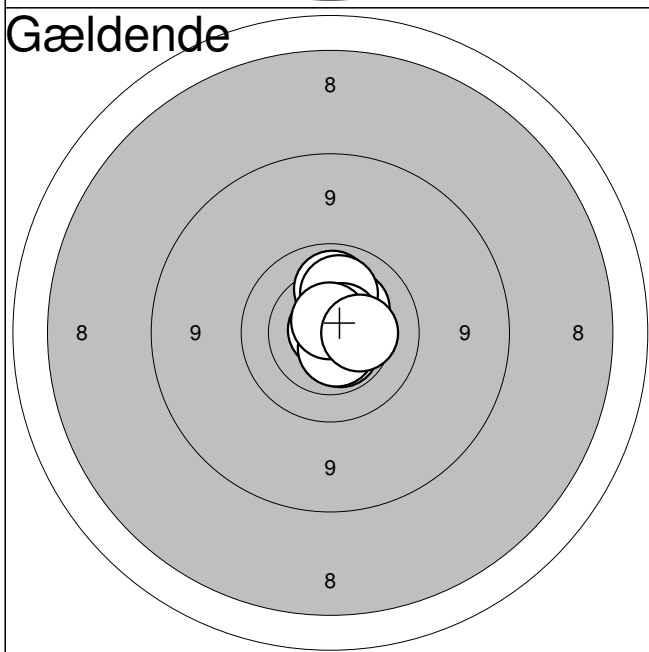

11:	10,8*	↗
12:	10,6*	↓
13:	10,3	↗
14:	10,1	↑
15:	10,2	↑
16:	10,6*	↗
17:	10,9*	↗
18:	10,6*	↓
19:	10,7*	↑
20:	10,4	→

Serie:	100,0
Sum:	200,0

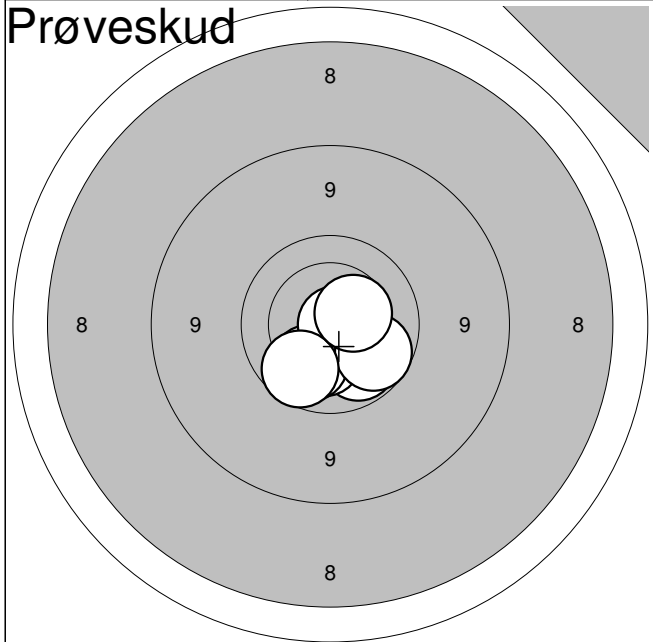

1:	10,0	↘
2:	10,5	→
3:	10,3	↘
4:	10,1	↘
5:	10,8*	→
6:	9,9	↘
7:	9,9	↘
8:	10,4	→

Serie: 78,0

Sum: 0,0

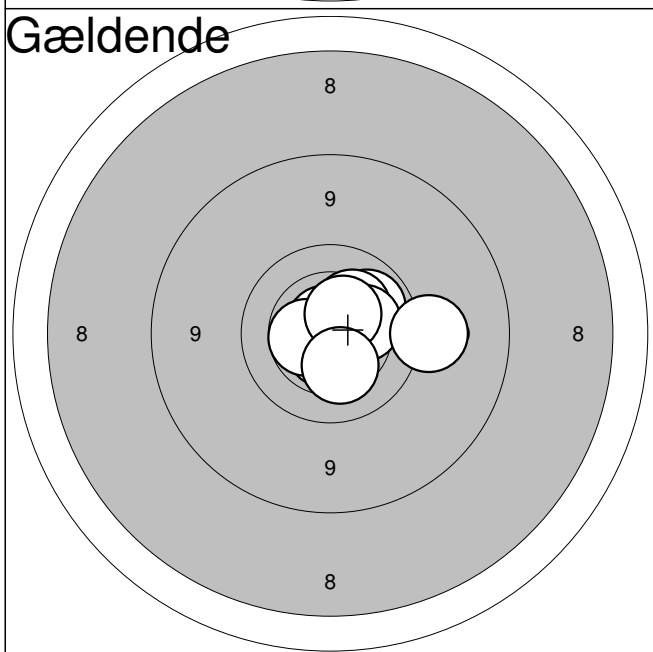

1:	10,1	↗
2:	10,6*	↘
3:	10,3	↗
4:	10,8*	↗
5:	10,3	→
6:	10,8*	↗
7:	9,4	→
8:	10,5*	←
9:	10,5*	↗
10:	10,3	↘

Serie: 99,0

Sum: 99,0

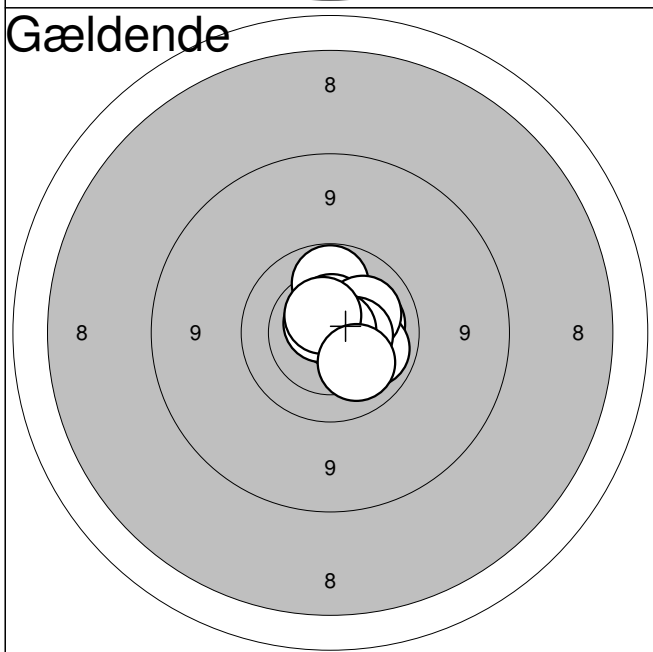

11:	10,0	↑
12:	10,2	→
13:	10,1	→
14:	10,6*	↑
15:	10,2	↗
16:	10,5	→
17:	10,8*	↗
18:	10,7*	↗
19:	10,6*	↗
20:	10,2	↘

Serie: 100,0

Sum: 199,0

Hold
60

Bane
11

Camilla K. Frydkjær

Hjørring Skytteforening

UNG

Jyllandsstævne 2011 - riffel

Aalborg Skyttekreds

Prøveskud

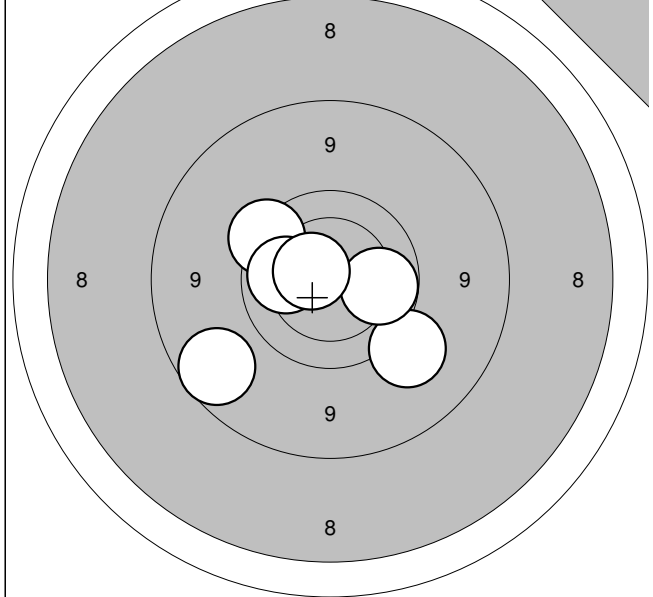

1:	9,7	↗
2:	10,1	←
3:	8,9	↘
4:	9,4	↘
5:	10,0	→
6:	10,6*	↗

Serie: 56,0

Sum: 0,0

Gældende

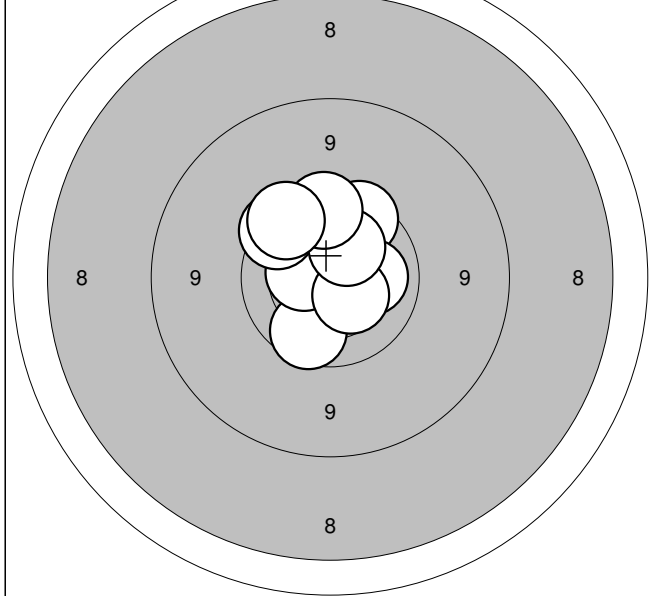

1:	9,8	↗
2:	10,3	↑
3:	10,2	→
4:	9,9	↘
5:	10,4	←
6:	10,4	↘
7:	9,7	↗
8:	10,3	↗
9:	9,8	↑
10:	9,7	↗

Serie: 95,0

Sum: 95,0

Gældende

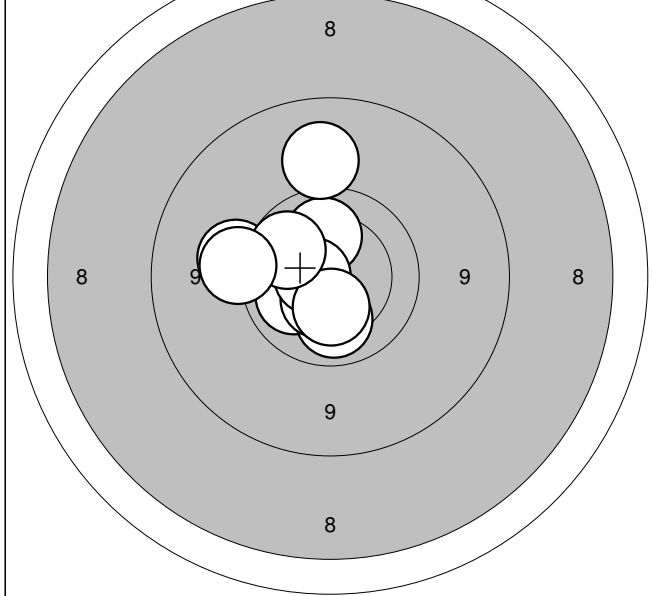

11:	10,2	↑
12:	10,2	←
13:	10,1	↘
14:	9,2	↑
15:	10,4	↘
16:	10,6*	←
17:	9,5	←
18:	10,4	↘
19:	10,0	↗
20:	9,5	←

Serie: 97,0

Sum: 192,0

Jyllandsstævne 2011

Hold

60

Bane

12

Allan Prior

D.F.B. Aalborg

V1

Jyllandsstævne 2011 - riffel

Aalborg Skyttekreds

Prøveskud

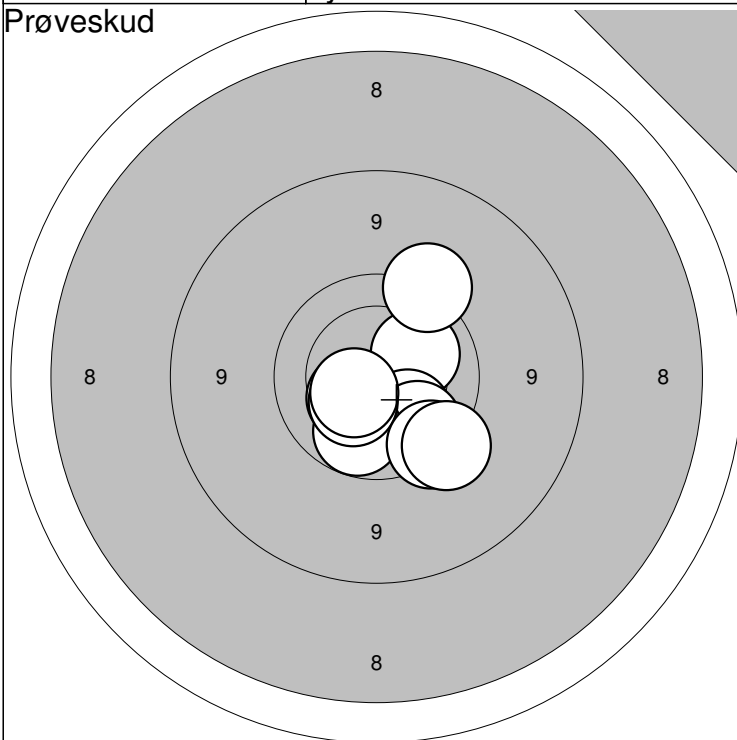

Prøveskud

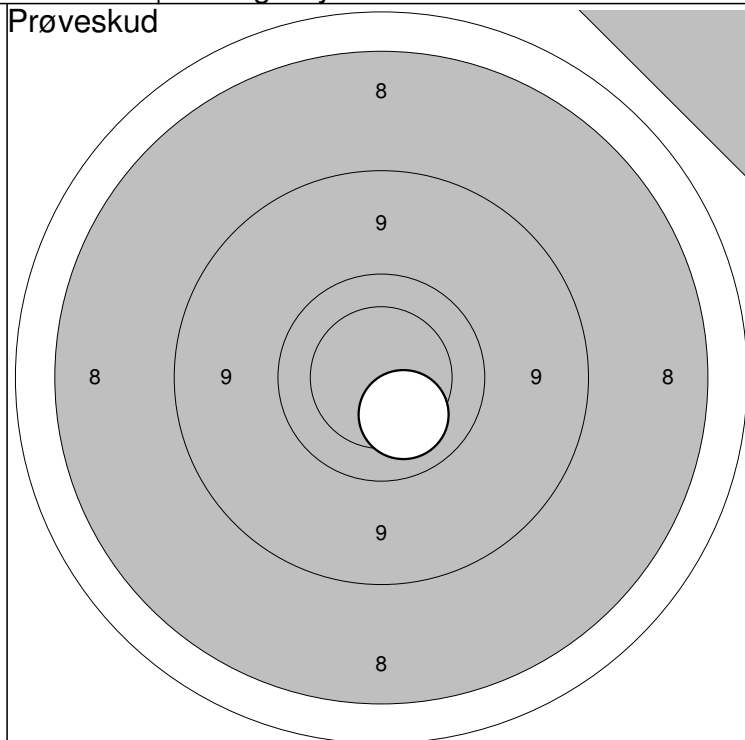

1:10,2



6:10,4



Serie: 96,0

11:10,2



Serie: 10,0

2:10,1



7:10,5



Sum: 0,0

Sum: 0,0

3: 9,9



8: 9,7



4:10,0



9: 9,5



5:10,4



10: 9,6



Gældende

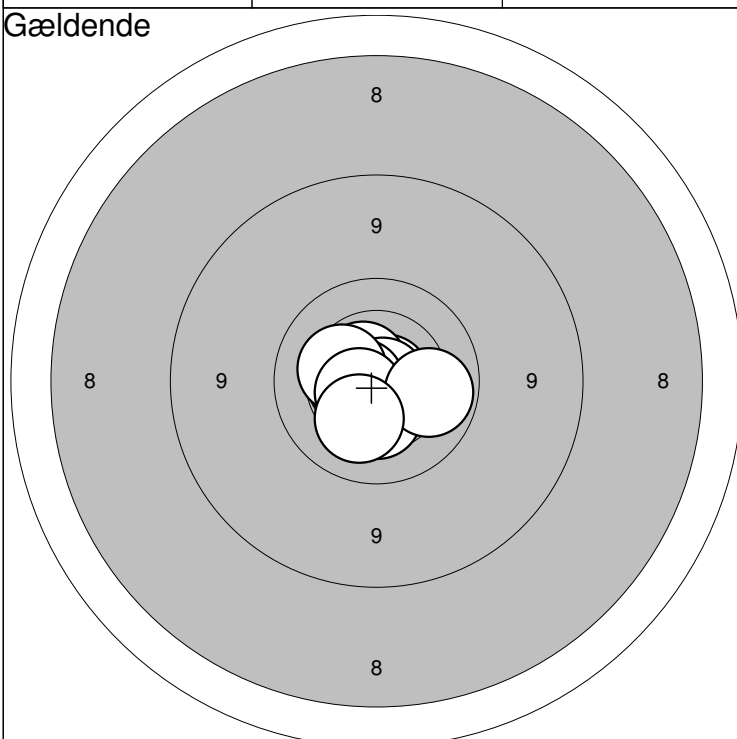

Gældende

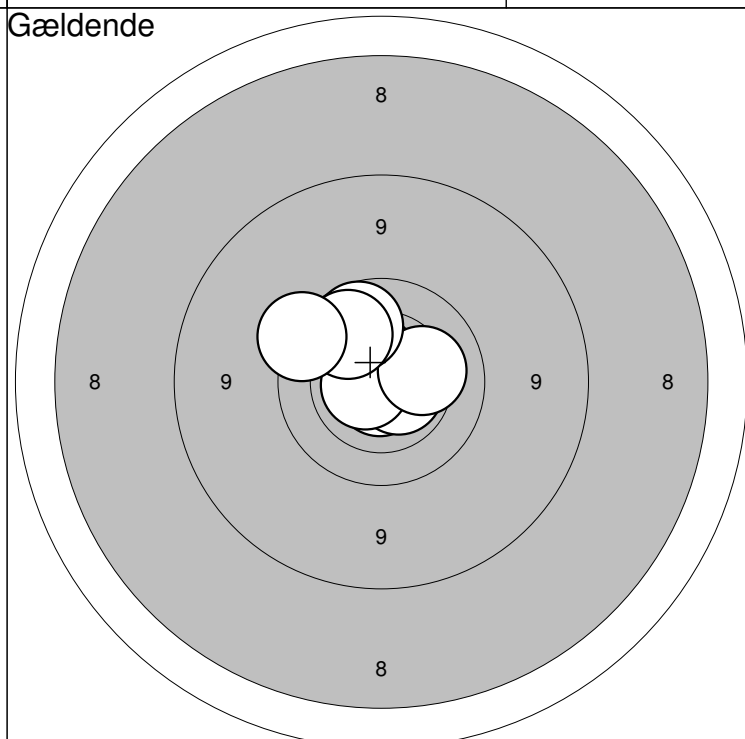

1:10,8*



6:10,4



Serie: 100,0

11:10,8*



16:10,7*



Serie: 98,0

2:10,5*



7:10,3



12:10,7*



17:10,2



3:10,6*



8:10,6*



Sum: 100,0

13:10,5*



18: 9,9



Sum: 198,0

4:10,8*



9:10,0



14:10,6*



19:10,0



5:10,7*



10:10,2



15:10,4



20: 9,6



Jyllandsstævne 2011

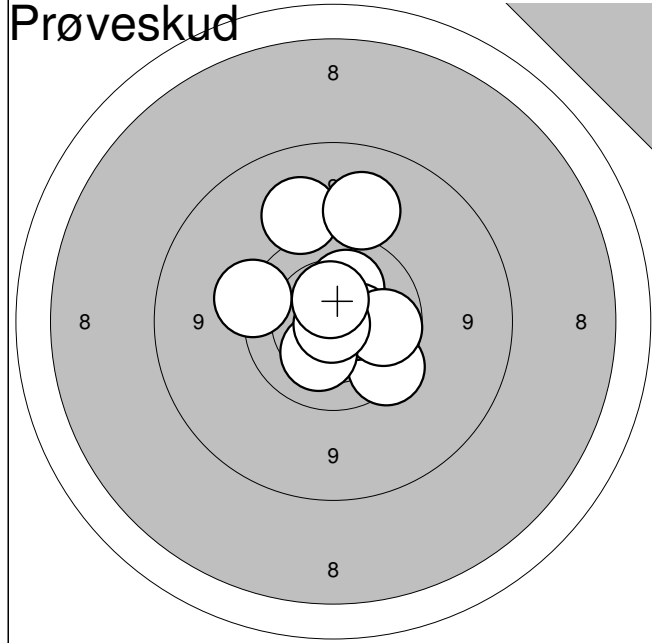

1:	10,3	↑
2:	9,7	↓
3:	10,5	→
4:	9,9	→
5:	9,3	↑
6:	10,3	↓
7:	9,2	↑
8:	9,6	←
9:	10,9*	↓
10:	10,5*	↑

Serie:	95,0
Sum:	0,0

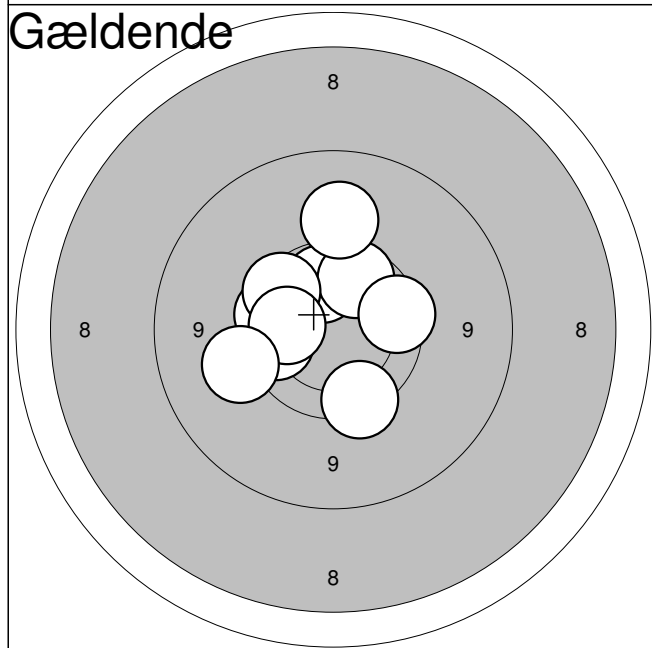

1:	9,9	←
2:	10,0	↑
3:	9,9	↑
4:	9,8	←
5:	9,3	↑
6:	9,8	↗
7:	9,8	→
8:	10,0	←
9:	9,4	←
10:	9,7	↓

Serie:	92,0
Sum:	92,0

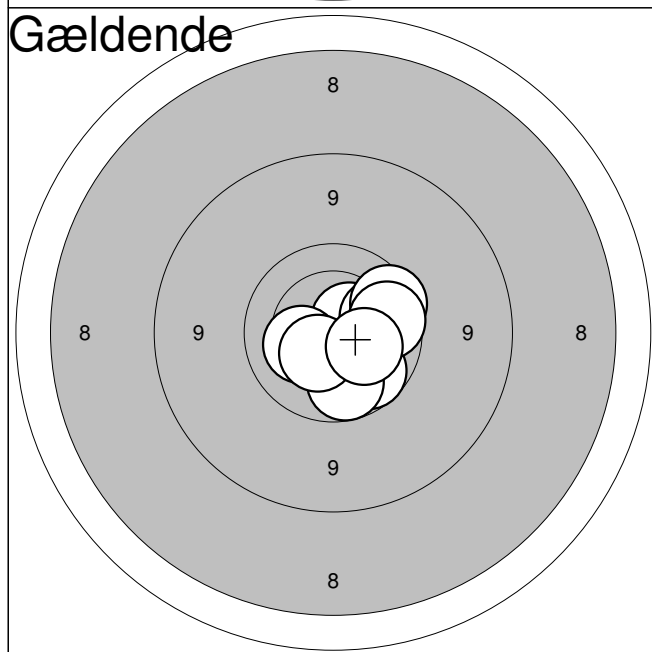

11:	10,5*	→
12:	9,9	↓
13:	10,6*	↗
14:	10,0	→
15:	10,3	←
16:	9,9	↓
17:	9,8	↗
18:	9,9	→
19:	10,4	↓
20:	10,3	↘

Serie:	96,0
Sum:	188,0

Ulsted Skf.

ÅK1

Jyllandsstævne 2011 - riffel

Aalborg Skyttekreds

Prøveskud

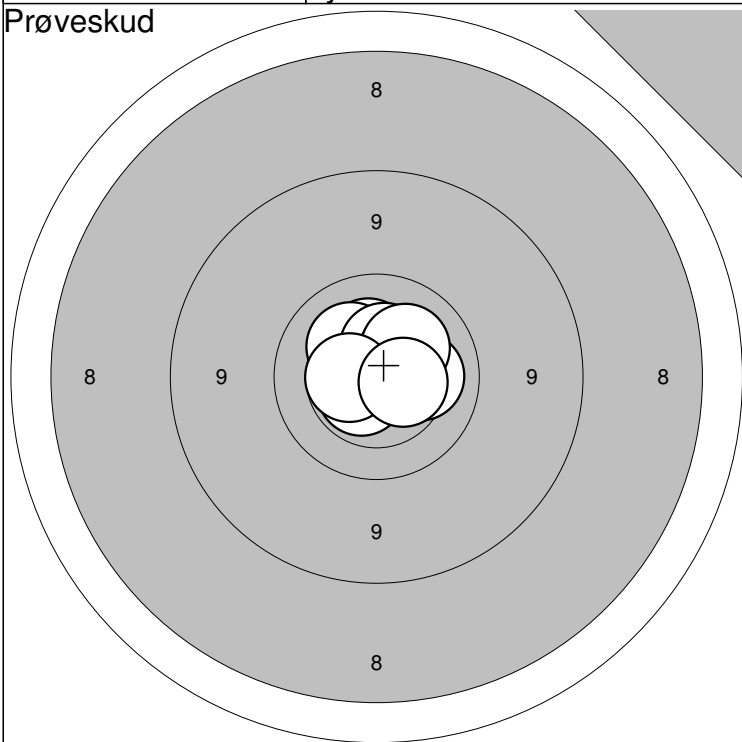

Prøveskud

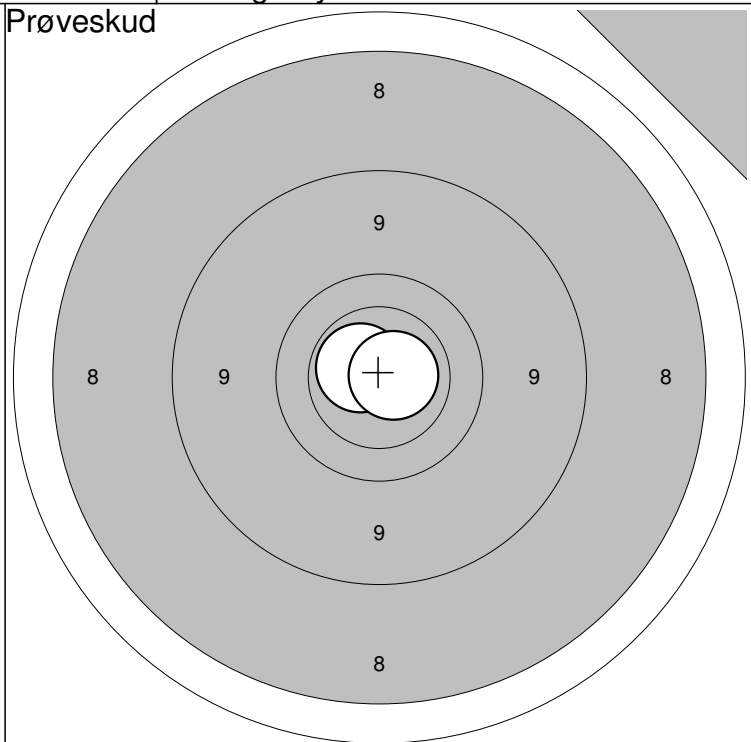

1:10,4

↑

6:10,4

↗

Serie: 100,0

2:10,3

↖

7:10,3

↗

11:10,6*

↖

Serie: 20,0

3:10,4

↑

8:10,6*

↙

12:10,7*

→

4:10,7*

→

9:10,5

←

Sum: 0,0

5:10,2

→

10:10,5*

→

Sum: 0,0

Gældende

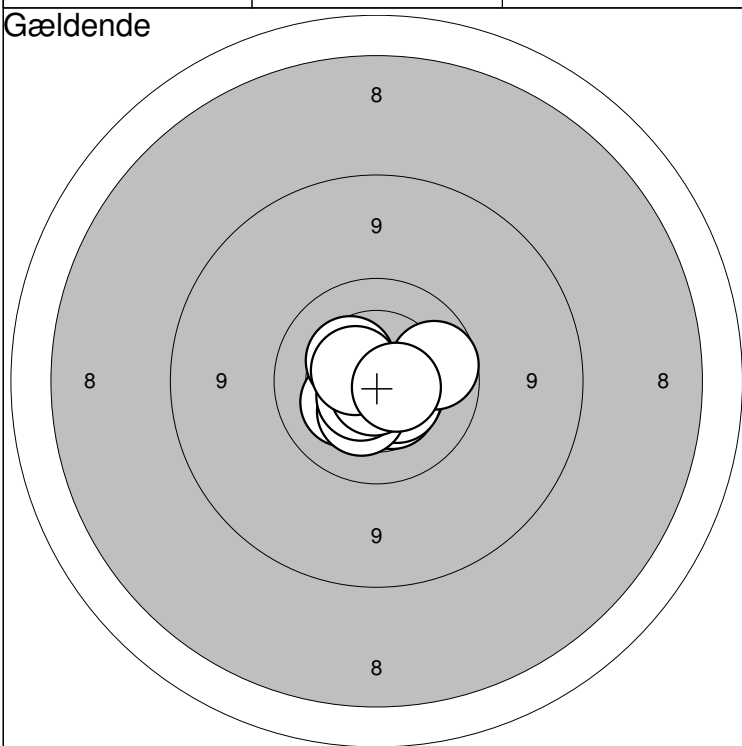

Gældende

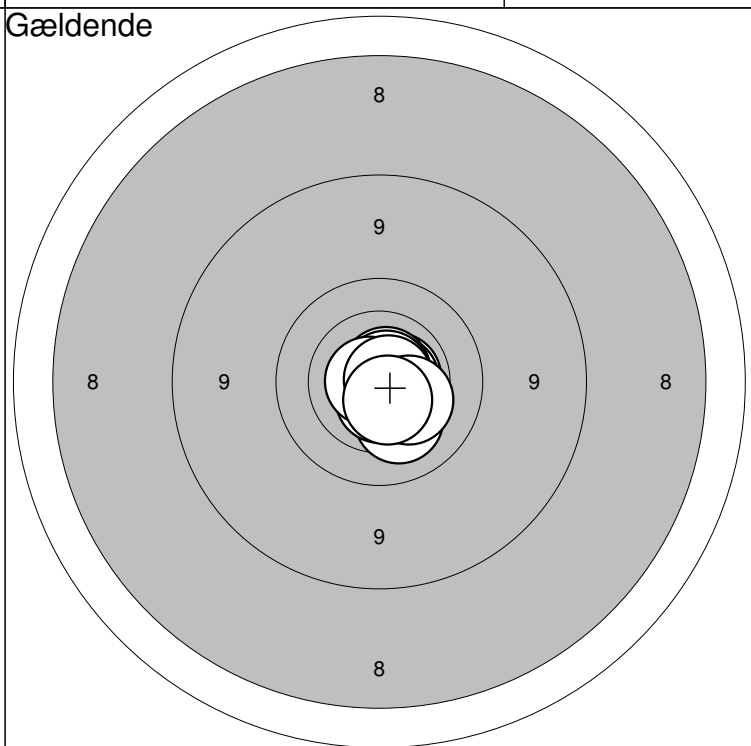

1:10,5

↘

6:10,4

↖

Serie: 99,0

11:10,6*

→

16:10,8*

↗

Serie: 100,0

2:10,3

↙

7:10,8*

↘

12:10,2

↘

17:10,8*

←

3:10,5*

↘

8:10,6*

↖

Sum: 99,0

13:10,7*

→

18:10,8*

→

Sum: 199,0

4:10,4

↘

9: 9,9

→

14:10,7*

↘

19:10,4

↘

5:10,6*

↙

10:10,6*

→

15:10,7*

↗

20:10,6*

↘

Vilsted Skf.

ÅK1

Jyllandsstævne 2011 - riffel

Aalborg Skyttekreds

Prøveskud

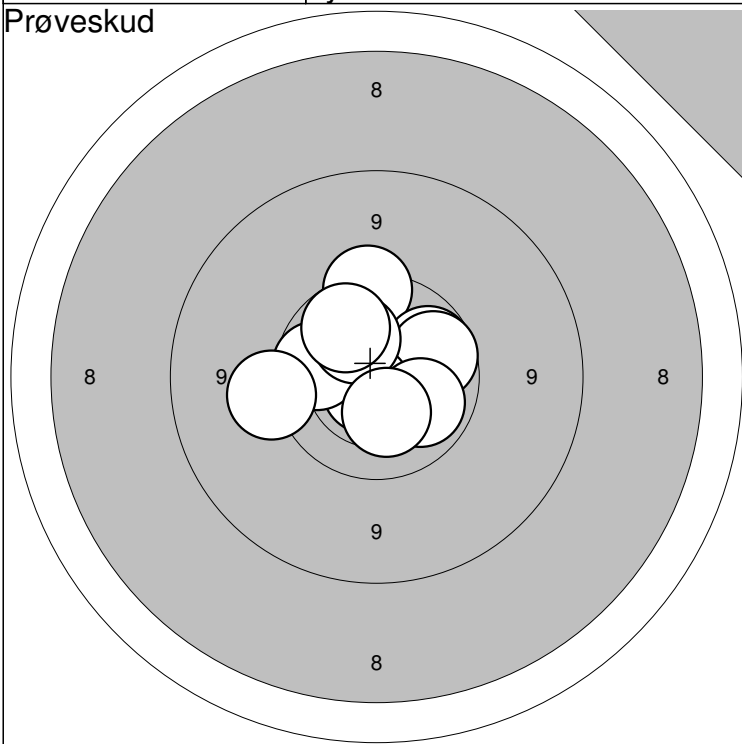

Prøveskud

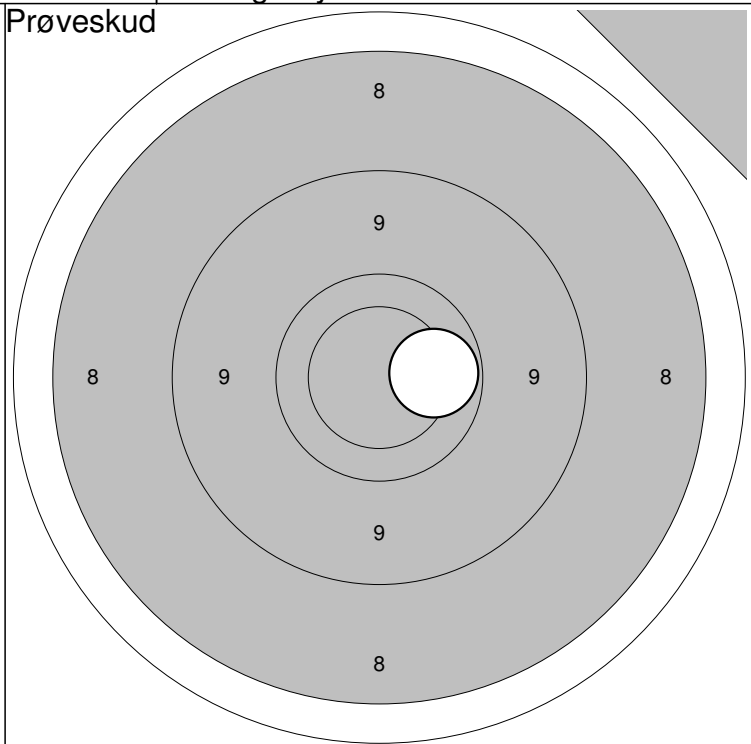

1: 9,7	↑	6: 9,5	←	Serie: 96,0
2: 10,0	↗	7: 10,2	↗	
3: 9,9	↗	8: 10,0	↗	Sum: 0,0
4: 10,7*	↘	9: 10,1	↘	
5: 9,9	←	10: 10,3	↘	

11: 10,0	→			Serie: 10,0
				Sum: 0,0

Gældende

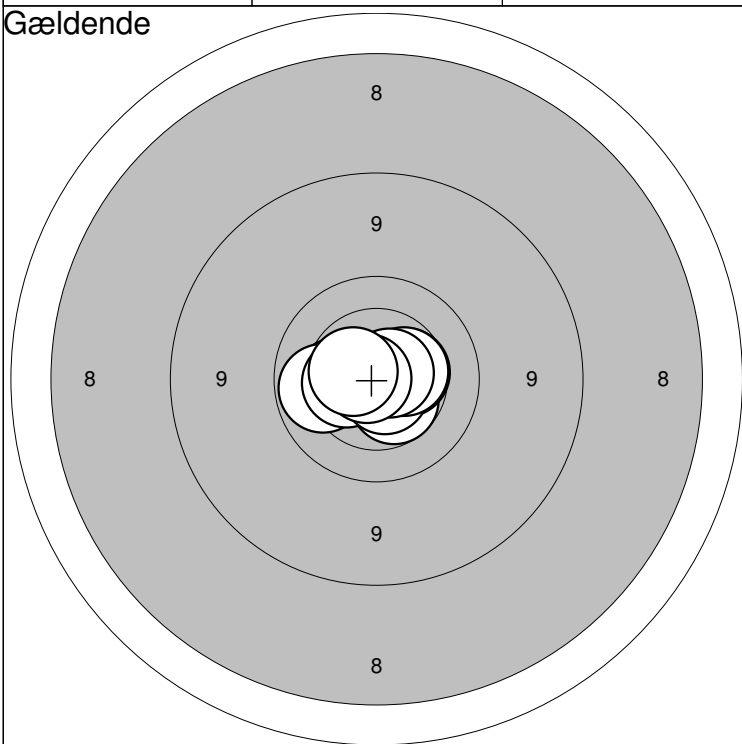

Gældende

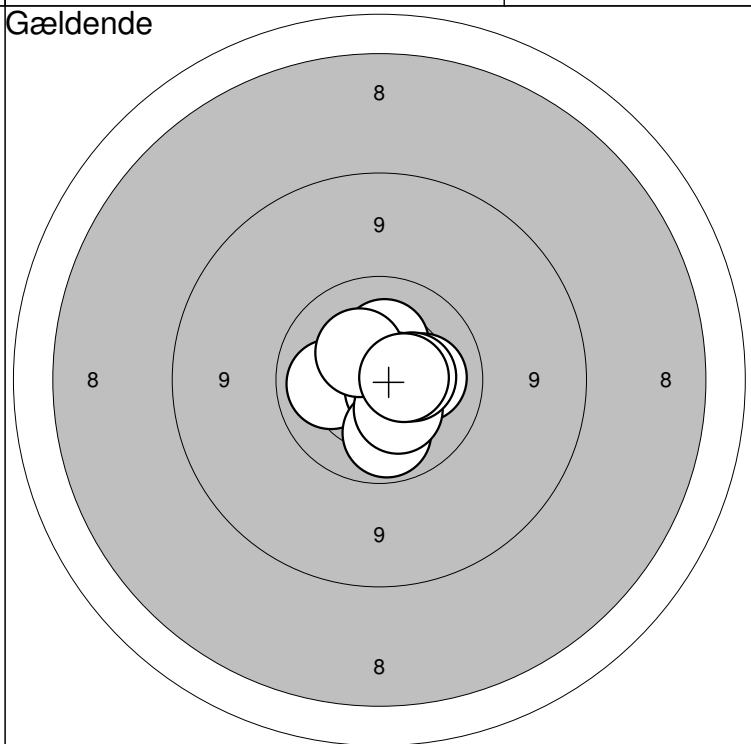

1: 10,3	←	6: 10,7*	↘	Serie: 100,0
2: 10,5	↘	7: 10,5	→	
3: 10,4	→	8: 10,7*	↗	Sum: 100,0
4: 10,0	←	9: 10,8*	←	
5: 10,4	←	10: 10,5*	←	

11: 10,3	↑	16: 10,2	→	Serie: 100,0
12: 10,1	←	17: 10,4	↘	
13: 10,7*	→	18: 10,4	→	Sum: 200,0
14: 10,7*	↘	19: 10,4	↗	
15: 10,0	↘	20: 10,5*	→	

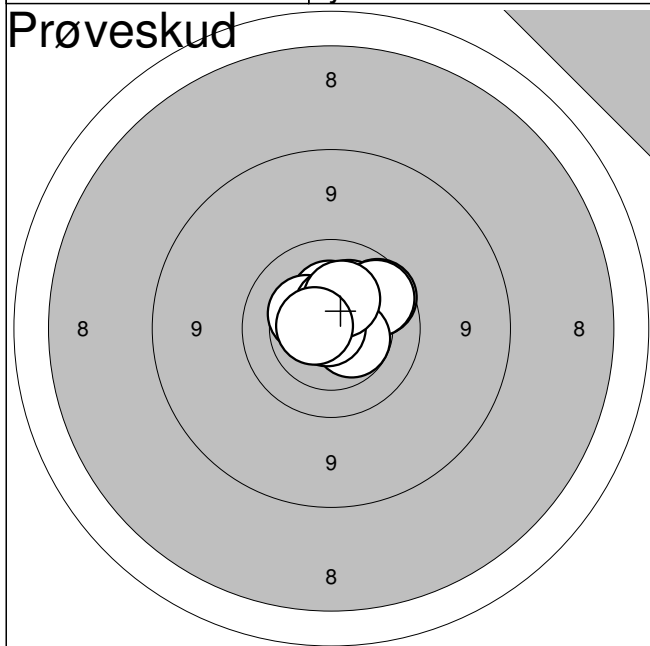

1:	9,9	↗
2:	10,3	↗
3:	9,9	↗
4:	10,4	↑
5:	10,5*	↘
6:	10,4	↗
7:	10,5*	↑
8:	10,9*	←
9:	10,3	↗
10:	10,6*	←

Serie: 98,0

Sum: 0,0

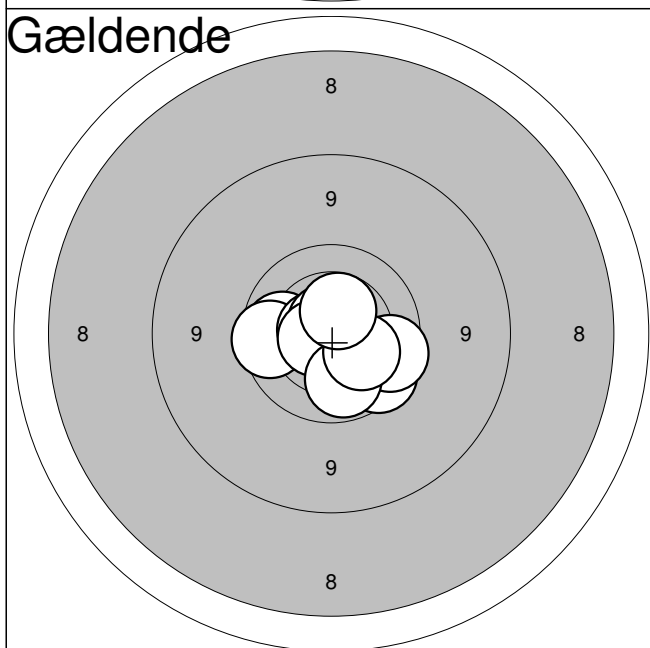

1:	10,0	←
2:	9,8	←
3:	10,6*	←
4:	10,7*	↗
5:	10,7*	←
6:	9,8	↘
7:	9,8	→
8:	10,0	↘
9:	10,2	↘
10:	10,5	↗

Serie: 97,0

Sum: 97,0

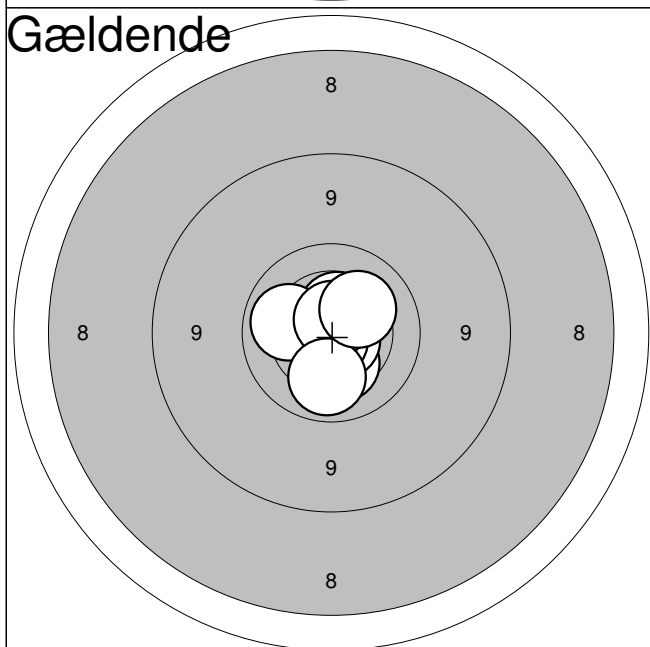

11:	10,8*	→
12:	10,4	↓
13:	10,5*	↗
14:	10,3	↓
15:	10,7*	↘
16:	10,8*	↓
17:	10,1	←
18:	10,7*	↑
19:	10,1	↓
20:	10,3	↗

Serie: 100,0

Sum: 197,0

Vilsted Skf.

ÅK2

Jyllandsstævne 2011 - riffel

Aalborg Skyttekreds

Prøveskud

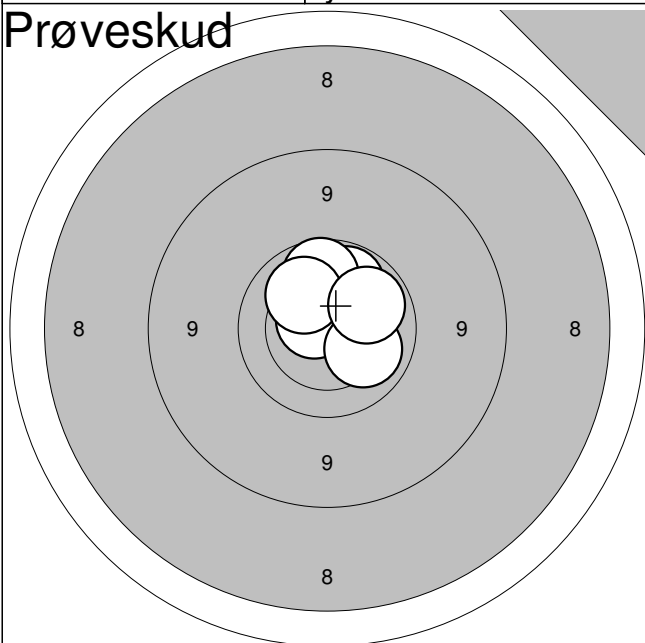

1:	10,0	↗
2:	9,9	↑
3:	10,7*	↗
4:	10,1	↘
5:	10,2	↗
6:	10,1	↗

Serie: 59,0

Sum: 0,0

Gældende

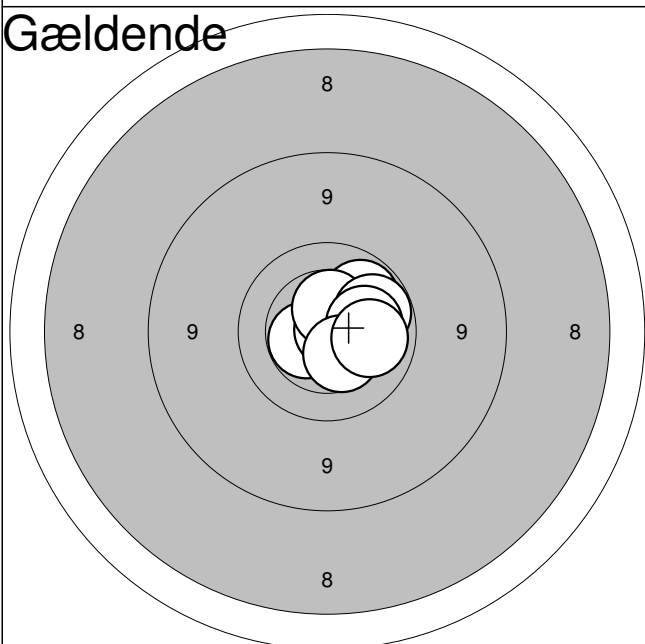

1:	10,3	→
2:	10,5*	→
3:	10,5*	←
4:	10,8*	→
5:	10,0	↗
6:	10,5*	↑
7:	10,0	→
8:	10,2	→
9:	10,4	↘
10:	10,1	→

Serie: 100,0

Sum: 100,0

Gældende

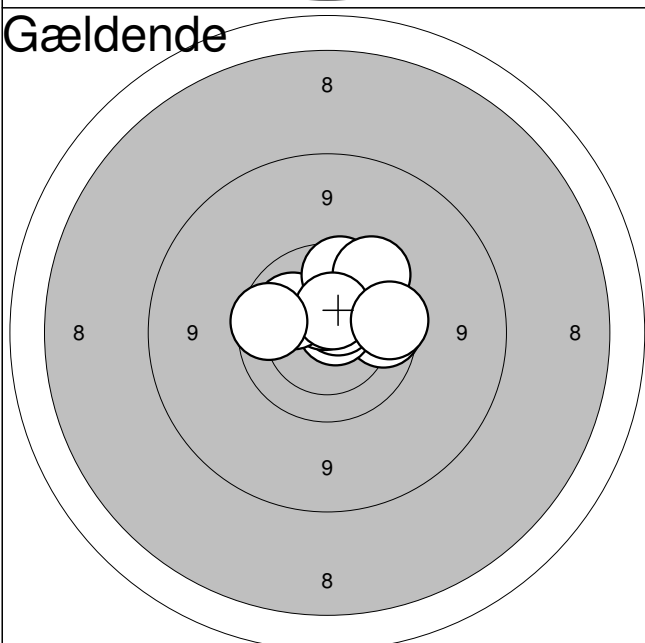

11:	9,9	→
12:	10,7*	↗
13:	10,6*	↗
14:	10,5*	↑
15:	10,2	↖
16:	9,9	↑
17:	9,7	↗
18:	10,5*	↑
19:	9,8	→
20:	9,9	←

Serie: 95,0

Sum: 195,0

Aalborg Skyttekreds

ÅK2

Jyllandsstævne 2011 - riffel

Aalborg Skyttekreds

Prøveskud

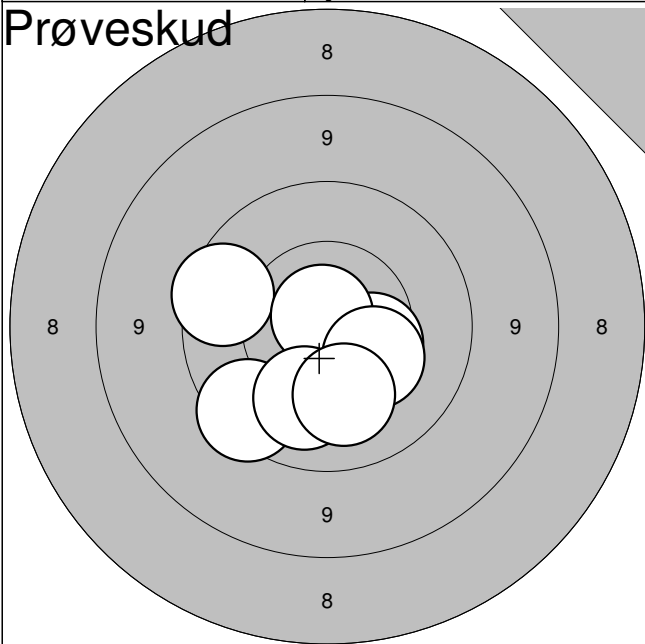

1:	10,5	↘
2:	9,8	↗
3:	10,4	→
4:	10,8*	↗
5:	9,7	↘
6:	10,4	↘
7:	10,2	↘
8:	10,2	↘

Serie: 78,0

Sum: 0,0

Gældende

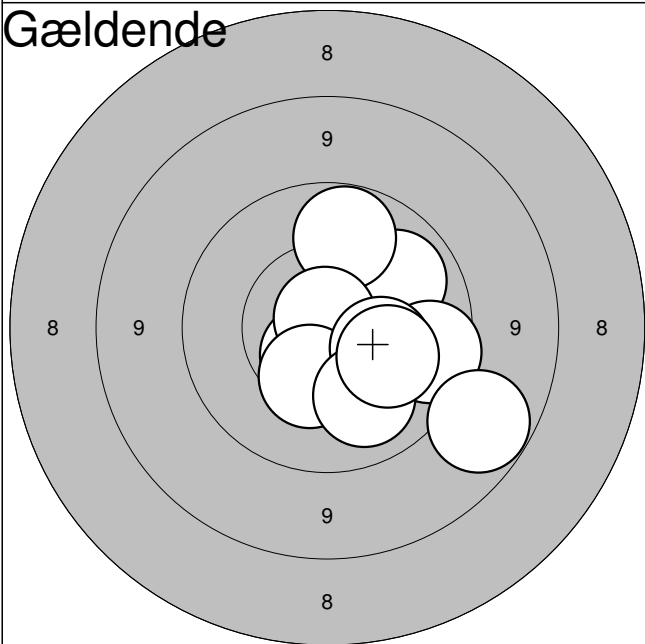

1:	10,6*	↘
2:	10,1	↗
3:	9,8	→
4:	10,0	↗
5:	10,8*	↗
6:	10,4	↘
7:	9,0	↘
8:	10,3	→
9:	10,1	↘
10:	10,2	→

Serie: 98,0

Sum: 98,0

Gældende

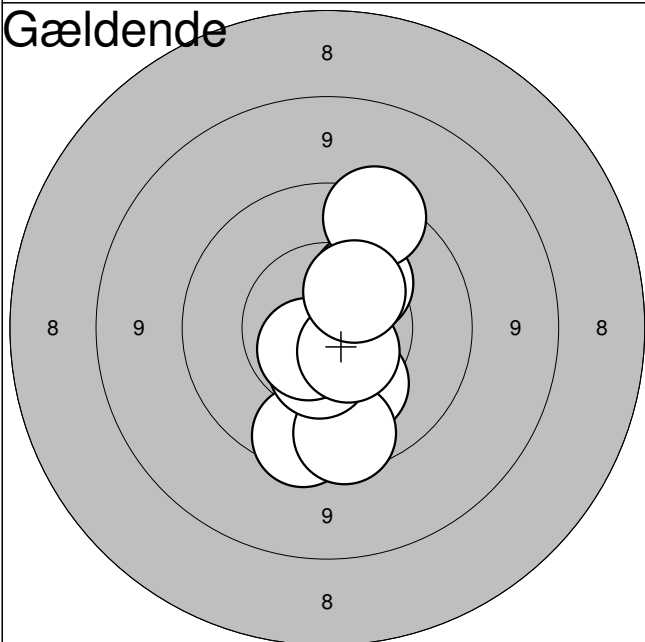

11:	10,4	↗
12:	10,3	↘
13:	9,8	↘
14:	10,6*	↘
15:	9,8	↘
16:	10,5	↘
17:	10,7*	↘
18:	9,6	↗
19:	10,6*	↘
20:	10,5	↗

Serie: 97,0

Sum: 195,0

Fræer og Omegns Skf.

ÅK3

Jyllandsstævne 2011 - riffel

Aalborg Skyttekreds

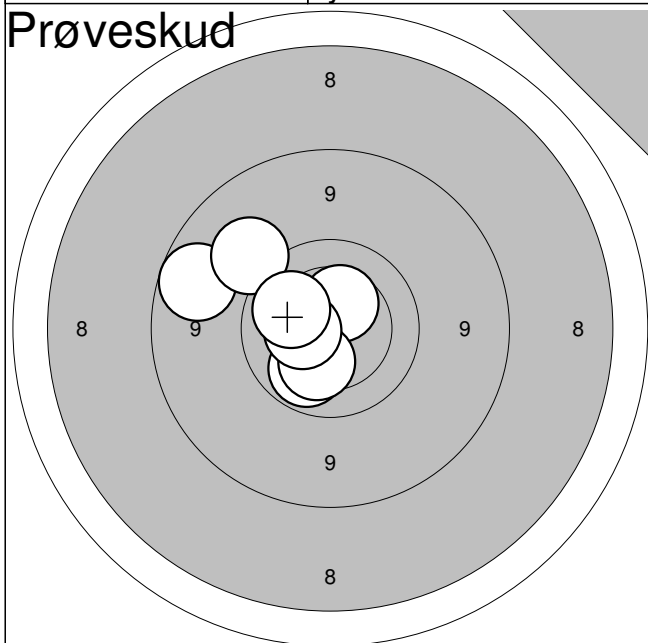
Prøveskud

1:	9,0	↖
2:	9,3	↗
3:	10,4	↗
4:	10,0	↘
5:	10,2	↘
6:	10,4	↖
7:	10,1	↖

Serie:	68,0
---------------	-------------

Sum:	0,0
-------------	------------

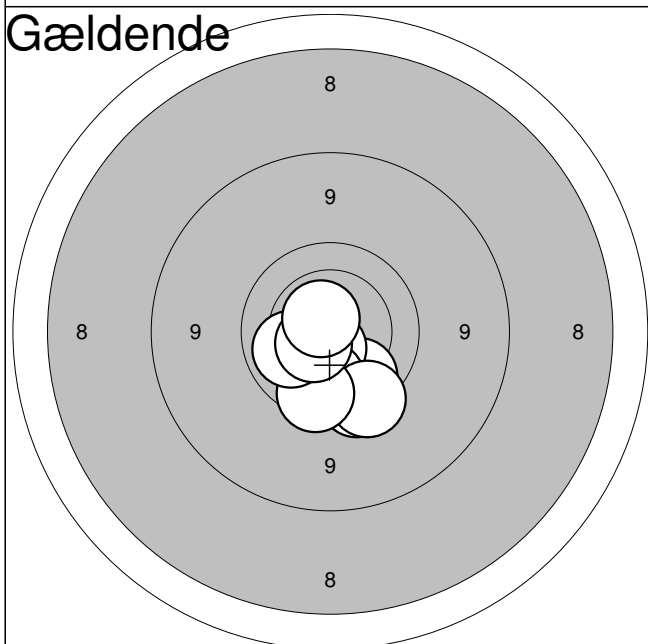
Gældende

1:	9,7	↘
2:	9,9	↘
3:	10,6*	↘
4:	10,5	↖
5:	10,0	↘
6:	9,7	↘
7:	9,8	↘
8:	10,1	↖
9:	10,6*	↖
10:	10,6*	↗

Serie:	96,0
---------------	-------------

Sum:	96,0
-------------	-------------

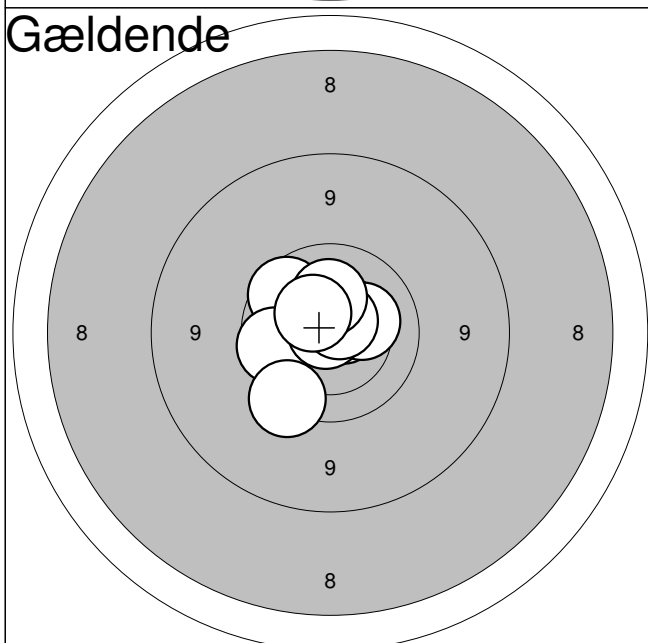
Gældende

11:	10,7*	↗
12:	10,6*	↗
13:	9,9	↗
14:	9,9	↖
15:	10,3	↗
16:	10,9*	↖
17:	10,7*	↗
18:	10,3	↗
19:	10,4	↗
20:	9,6	↘

Serie:	97,0
---------------	-------------

Sum:	193,0
-------------	--------------

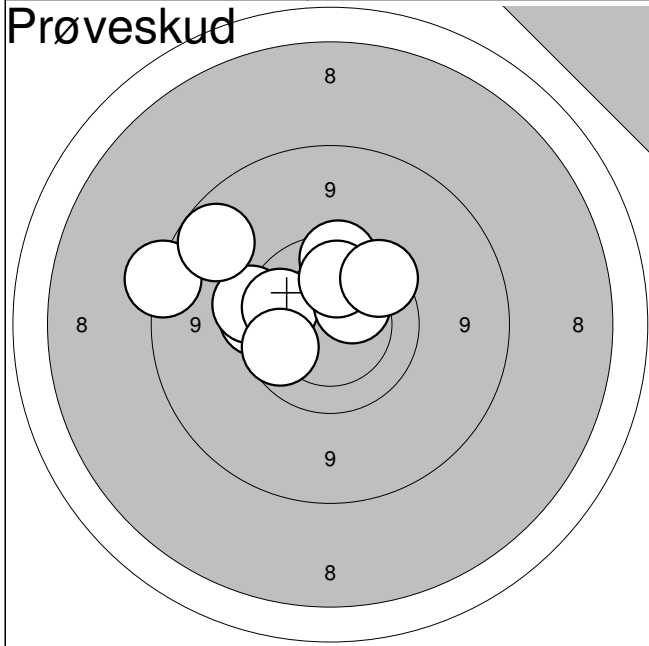

1:	9,7	←
2:	8,7	←
3:	9,6	←
4:	9,0	↗
5:	9,9	←
6:	9,8	↑
7:	10,4	↗
8:	10,1	↑
9:	9,8	↗
10:	9,9	←

Serie:	91,0
Sum:	0,0

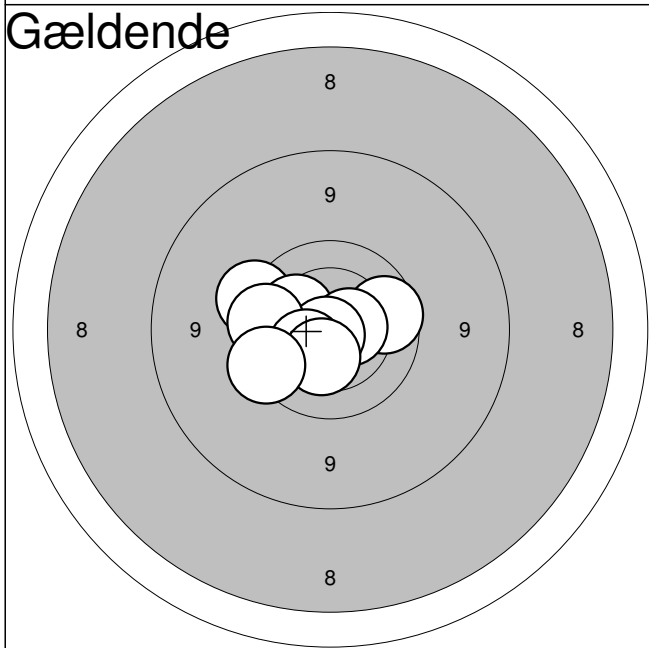

1:	9,6	←
2:	9,9	→
3:	10,0	←
4:	10,2	←
5:	10,6*	→
6:	10,8*	↓
7:	9,8	←
8:	10,4	↓
9:	10,4	↓
10:	9,7	←

Serie:	96,0
Sum:	96,0

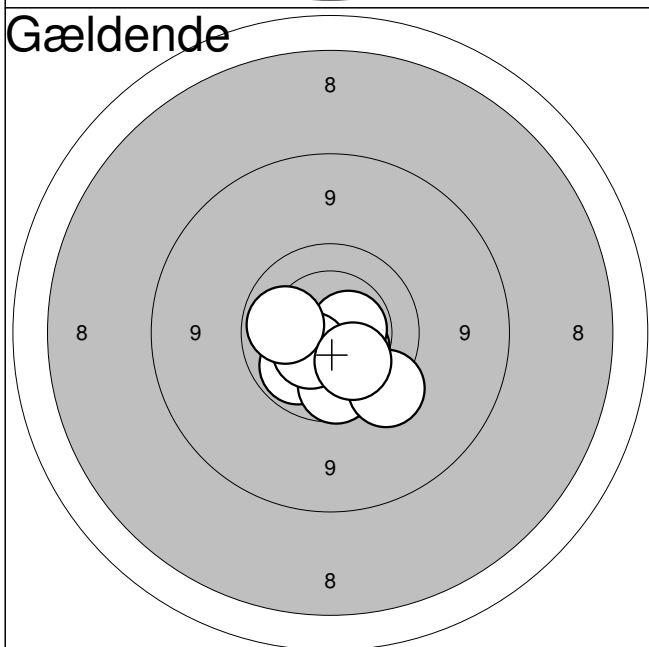

11:	10,0	↘
12:	10,4	↘
13:	10,7*	↘
14:	10,5*	↘
15:	10,6*	→
16:	9,9	↓
17:	10,4	↘
18:	10,1	←
19:	9,6	↘
20:	10,2	↘

Serie:	98,0
Sum:	194,0

Fræer og Omegns Skf.

J2

Jyllandsstævne 2011 - riffel

Aalborg Skyttekreds

Prøveskud

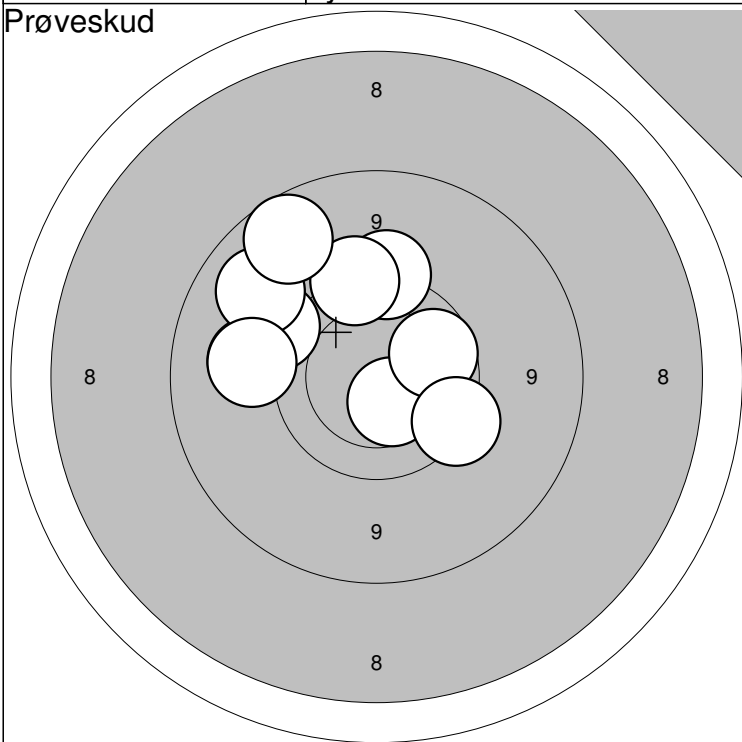

Prøveskud

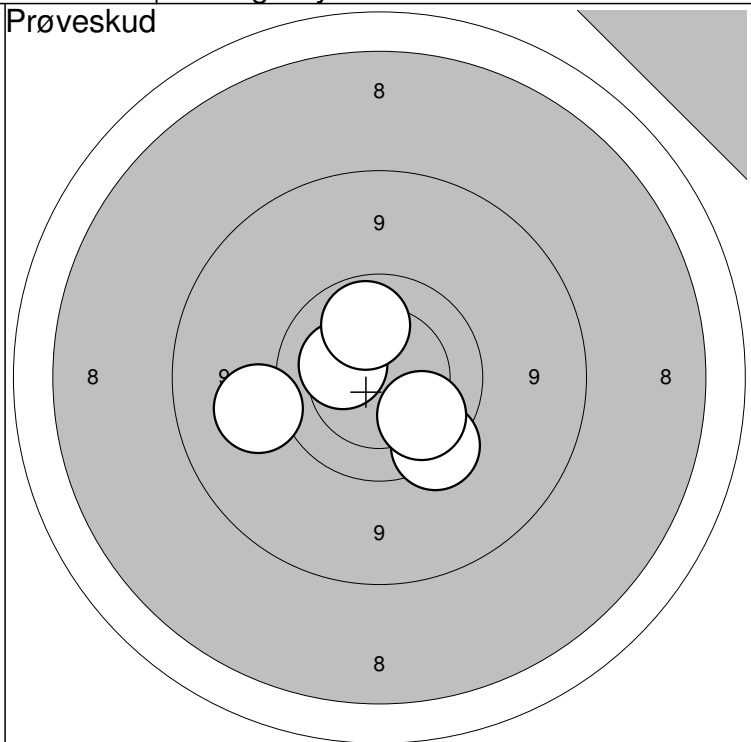

1: 9,3 ←

2: 9,5 ↑

3: 9,6 ↑

4: 10,5 ↓

5: 9,9 →

6: 9,4 ↗

7: 9,1 ↗

8: 8,9 ↗

9: 9,6 ↓

10: 9,3 ←

Serie: 90,0

Sum: 0,0

11: 9,3 ←

12: 9,7 ↓

13: 10,3 ↖

14: 10,0 ↑

15: 10,0 ↓

Serie: 48,0

Sum: 0,0

Gældende

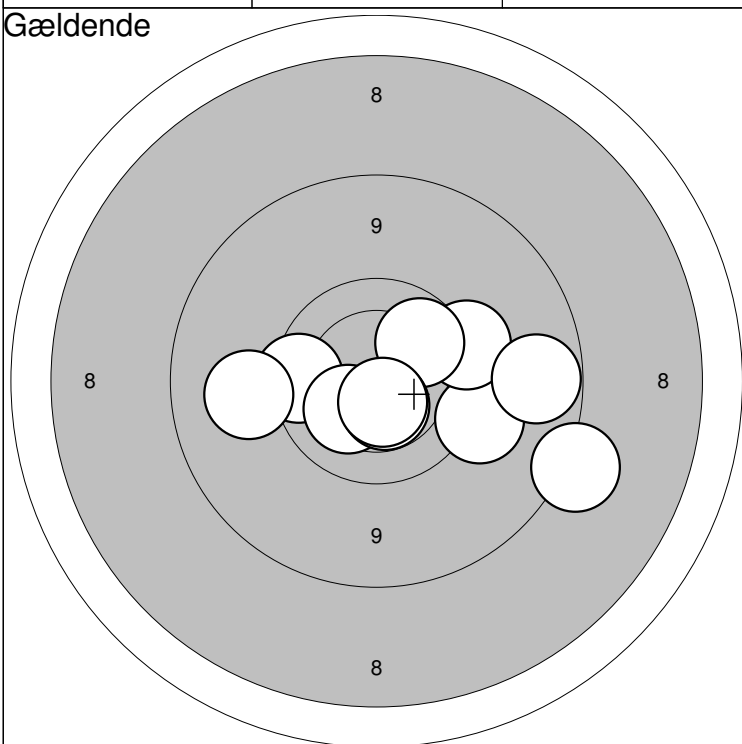

Gældende

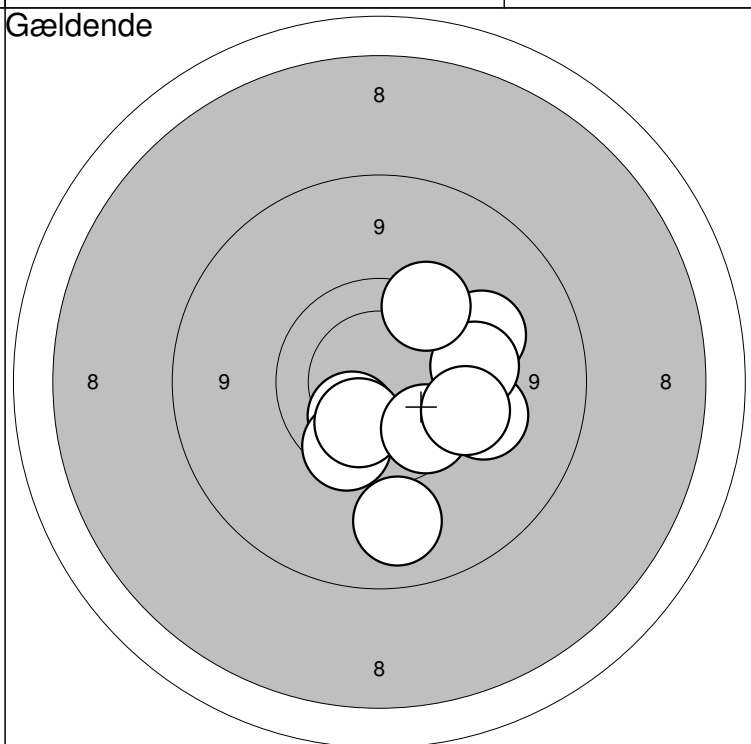

1: 9,5 →

2: 9,8 ←

3: 9,3 ←

4: 9,6 →

5: 10,0 ↗

6: 9,0 →

7: 10,3 ↓

8: 10,5* ↓

9: 10,6* ↓

10: 8,6 →

Serie: 93,0

Sum: 93,0

11: 9,4 ↗

12: 9,5 →

13: 9,6 →

14: 10,2 ↓

15: 9,8 ↓

16: 9,2 ↓

17: 10,2 ↓

18: 9,9 ↓

19: 9,7 ↗

20: 9,6 →

Serie: 92,0

Sum: 185,0

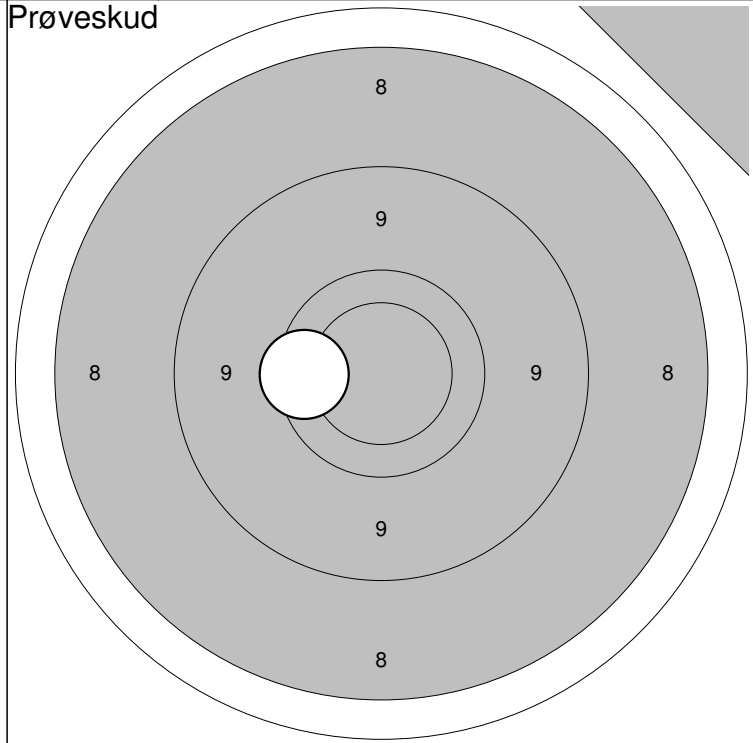
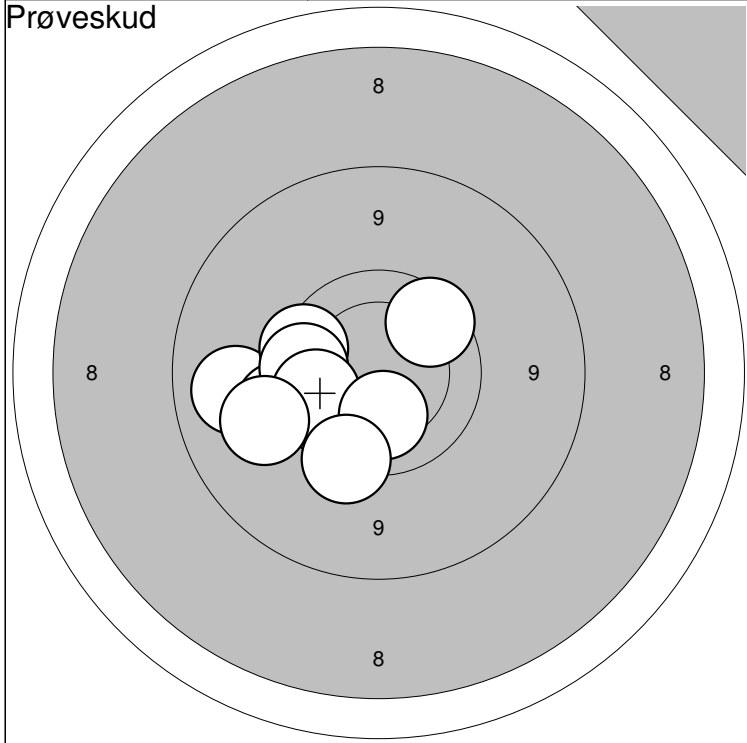

1: 9,1 ←	6: 9,9 ←	Serie: 91,0
2: 9,9 ↙	7:10,2 ↓	
3: 9,5 ←	8: 9,8 ↗	Sum: 0,0
4: 9,8 ↖	9: 9,6 ↓	
5: 9,8 ←	10: 9,3 ←	

11: 9,8 ←	Serie: 9,0
	Sum: 0,0

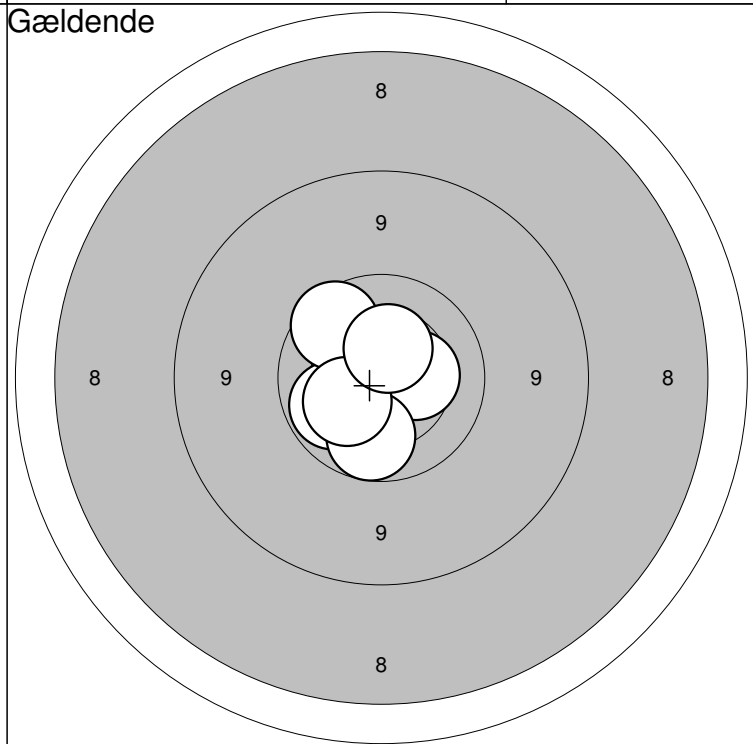
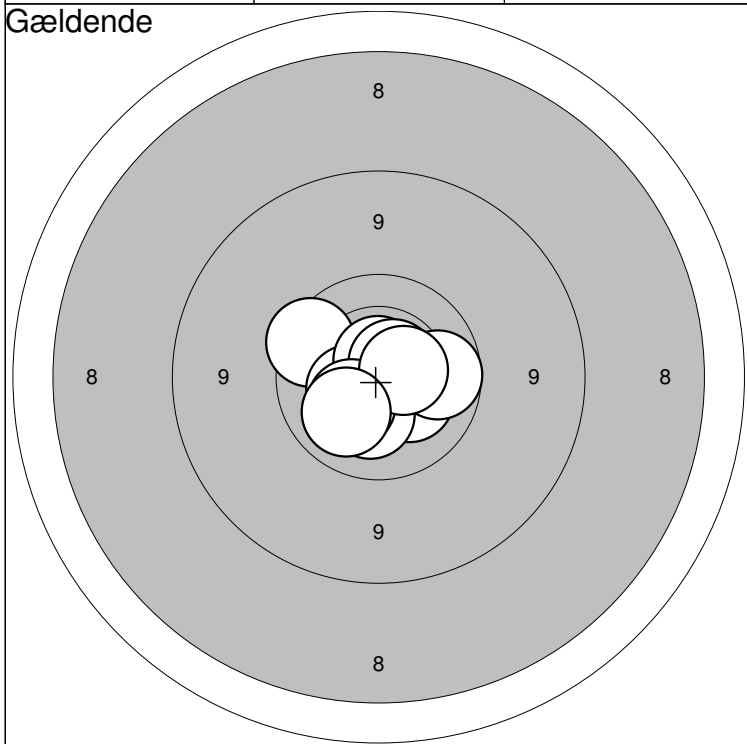

1: 9,8 ↖	6:10,6* ↗	Serie: 98,0
2:10,3 ↘	7: 9,9 →	
3:10,4 ↙	8:10,3 ↘	Sum: 98,0
4:10,3 ↓	9:10,5* →	
5:10,7* ↑	10:10,1 ↙	

11:10,0 ↖	16:10,7* →	Serie: 98,0
12:10,5 ↙	17:10,4 →	
13:10,8* ↓	18: 9,9 ↓	Sum: 196,0
14:10,5 ↙	19:10,2 ↖	
15: 9,9 ↘	20:10,4 ↑	

Fræer og Omegns Skf.

V2

Jyllandsstævne 2011 - riffel

Aalborg Skyttekreds

Prøveskud

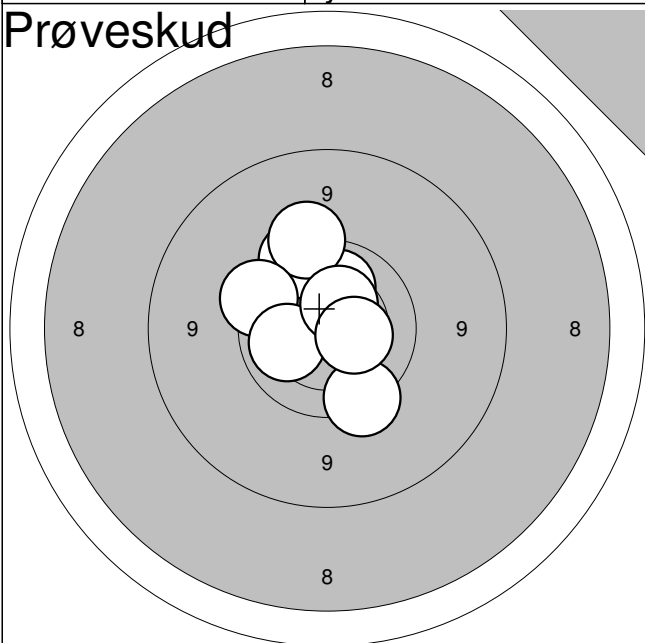

1:	9,7	↘
2:	10,1	↗
3:	9,7	↗
4:	9,5	↗
5:	9,7	↖
6:	10,1	↖
7:	10,4	↗
8:	10,4	→

Serie: 76,0

Sum: 0,0

Gældende

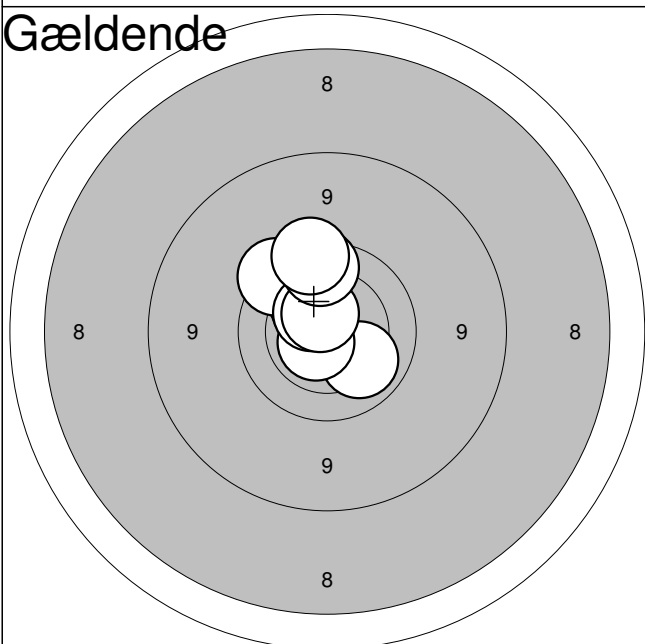

1:	10,4	↗
2:	9,8	↗
3:	10,2	↗
4:	10,1	↘
5:	10,6*	↘
6:	9,7	↗
7:	10,5	↗
8:	10,6*	↗
9:	9,8	↗
10:	9,7	↗

Serie: 96,0

Sum: 96,0

Gældende

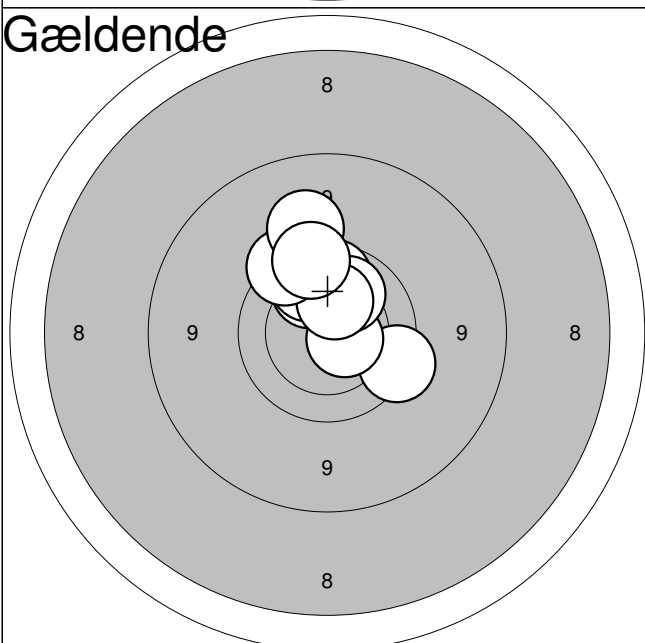

11:	9,7	↘
12:	9,9	↗
13:	10,6*	↘
14:	10,1	↗
15:	10,0	↗
16:	9,9	↗
17:	10,3	↗
18:	9,7	↗
19:	9,3	↗
20:	9,7	↗

Serie: 94,0

Sum: 190,0

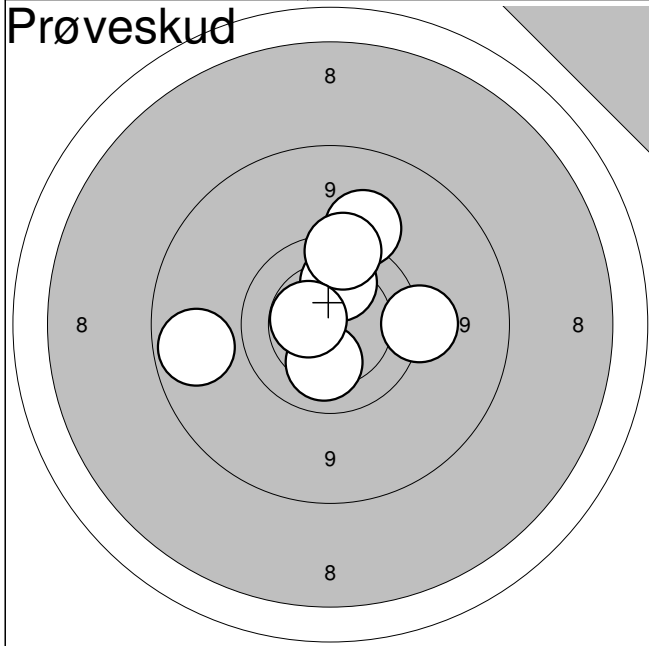

1:	9,0	←
2:	10,1	↑
3:	9,4	↑
4:	9,7	↑
5:	10,2	↓
6:	9,5	→
7:	10,5*	←

Serie:	66,0
Sum:	0,0

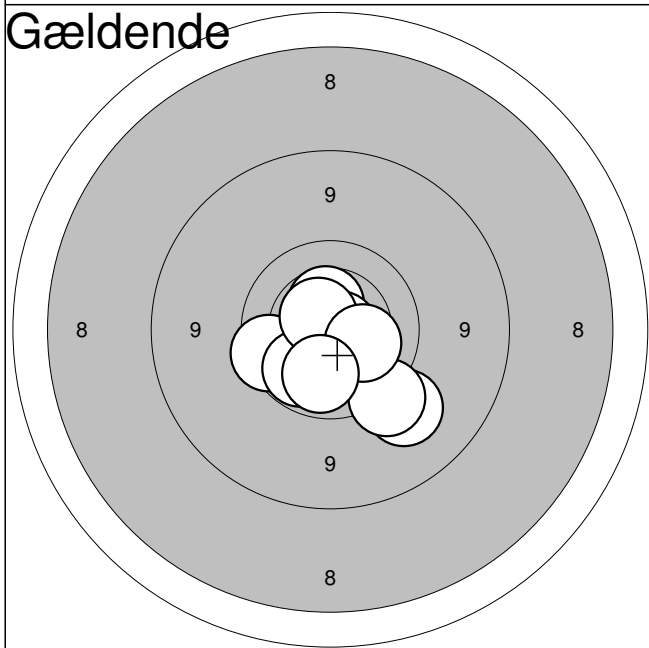

1:	10,3	↓
2:	9,8	←
3:	9,3	↓
4:	10,5	↑
5:	10,0	↓
6:	10,8*	→
7:	9,5	↓
8:	10,6*	↗
9:	10,3	→
10:	10,1	↓

Serie:	97,0
Sum:	97,0

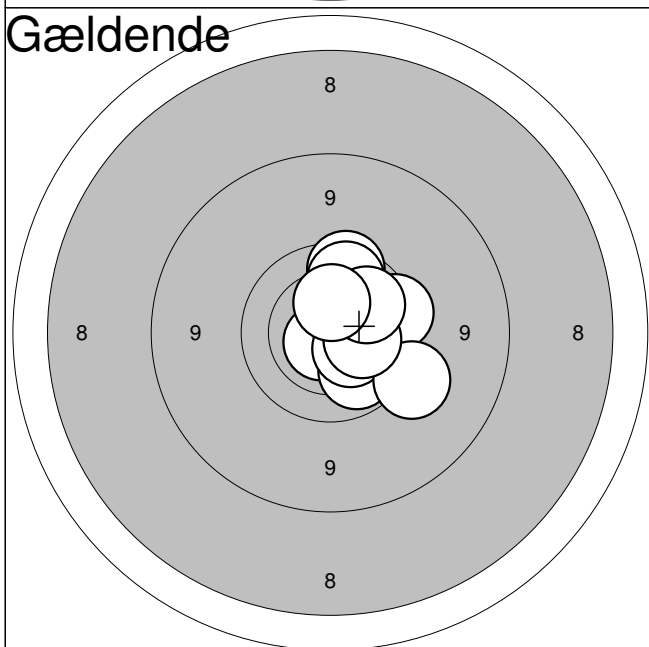

11:	9,8	↑
12:	9,8	→
13:	10,7*	↓
14:	10,0	↓
15:	10,4	↓
16:	9,5	↓
17:	9,9	↑
18:	10,3	→
19:	10,0	↗
20:	10,4	↑

Serie:	96,0
Sum:	193,0

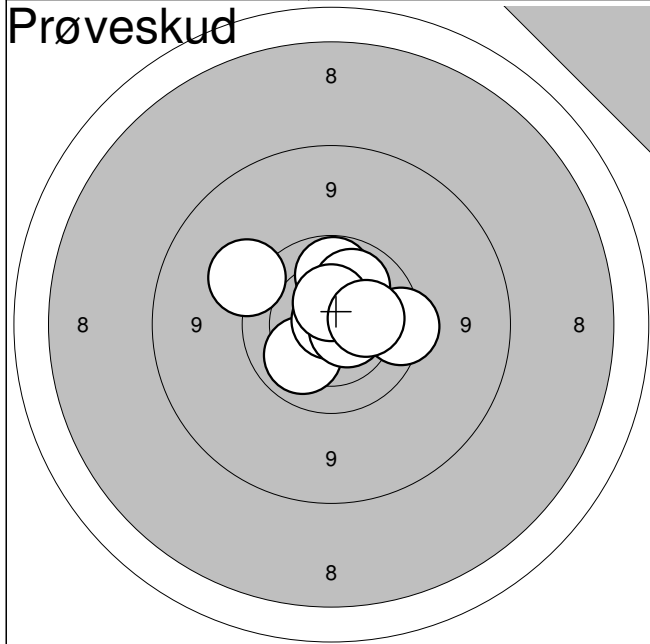

1:	10,1	↘
2:	10,9*	↑
3:	10,6*	→
4:	9,7	→
5:	10,0	↑
6:	9,4	↖
7:	10,6*	→
8:	10,1	↗
9:	10,5*	↑
10:	10,2	→

Serie: 98,0

Sum: 0,0

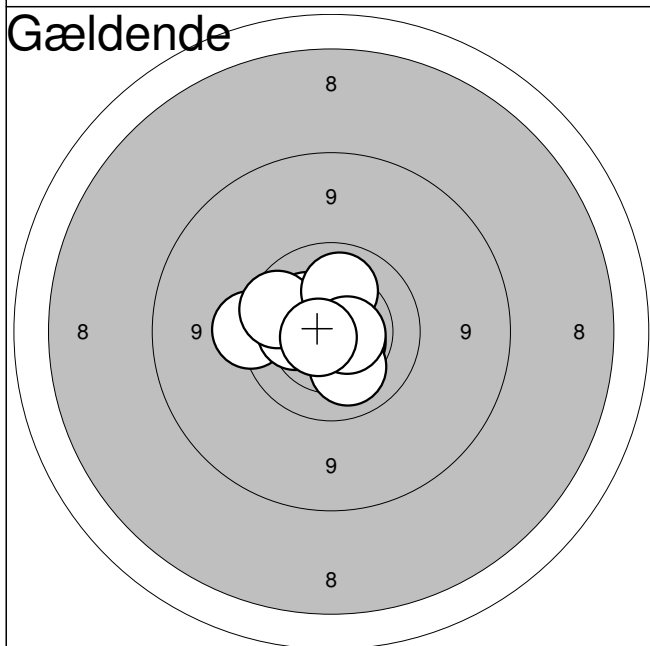

1:	10,8*	↑
2:	9,6	←
3:	10,6*	↘
4:	10,3	←
5:	10,3	↗
6:	9,9	↖
7:	10,1	↑
8:	10,2	↘
9:	10,6*	→
10:	10,7*	↙

Serie: 98,0

Sum: 98,0

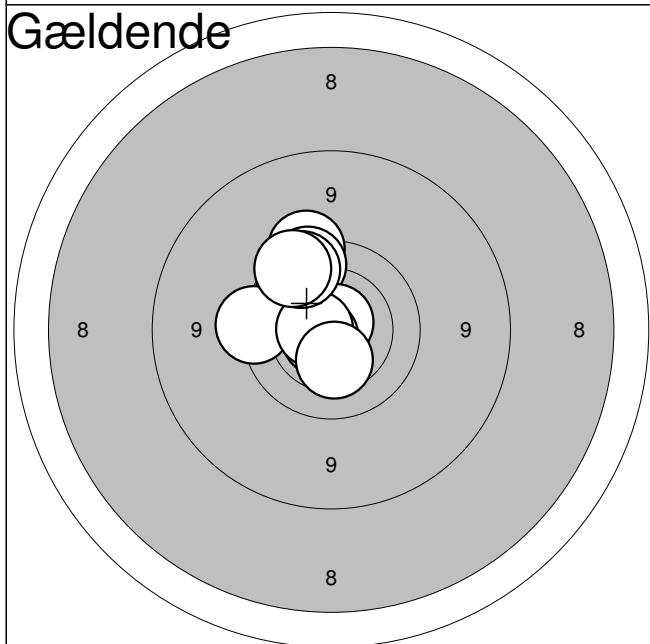

11:	10,0	↗
12:	9,6	↑
13:	9,8	↗
14:	10,8*	↗
15:	10,7*	↖
16:	9,7	←
17:	10,6*	←
18:	9,8	↗
19:	9,7	↗
20:	10,3	↘

Serie: 95,0

Sum: 193,0

Hold

62

Bane

3

Casper Krogh Frydkjær

Hjørring Skytteforening

J1

Jyllandsstævne 2011 - riffel

Aalborg Skyttekreds

Prøveskud

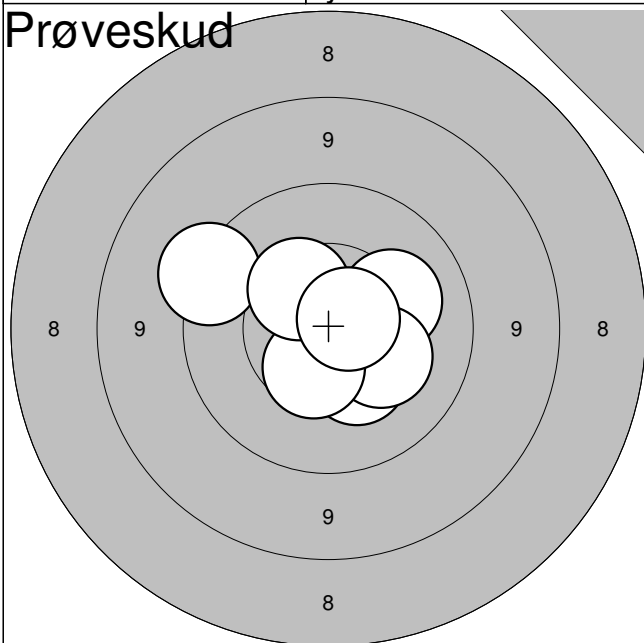

1:	10,4	↘
2:	9,5	↗
3:	10,2	→
4:	10,3	↘
5:	10,5	↘
6:	10,4	↗
7:	10,7*	→

Serie: 69,0

Sum: 0,0

Gældende

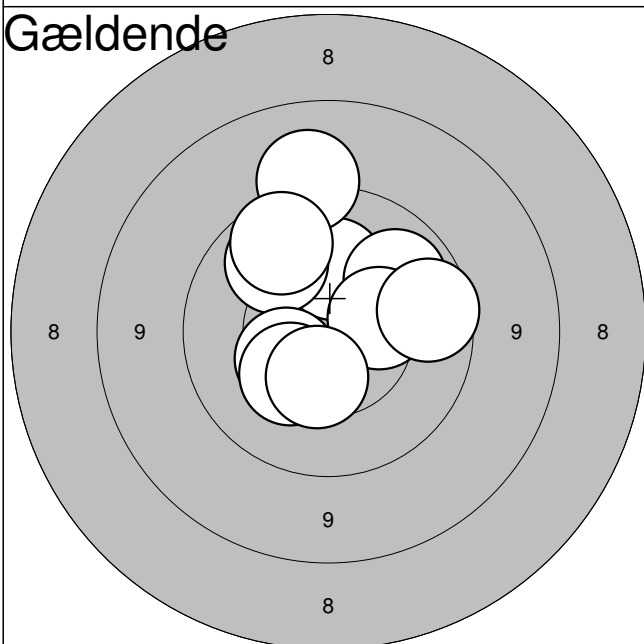

1:	10,3	↑
2:	10,0	↗
3:	10,1	↗
4:	9,3	↑
5:	9,9	↗
6:	10,4	→
7:	10,4	↘
8:	9,9	→
9:	10,3	↘
10:	10,4	↓

Serie: 97,0

Sum: 97,0

Gældende

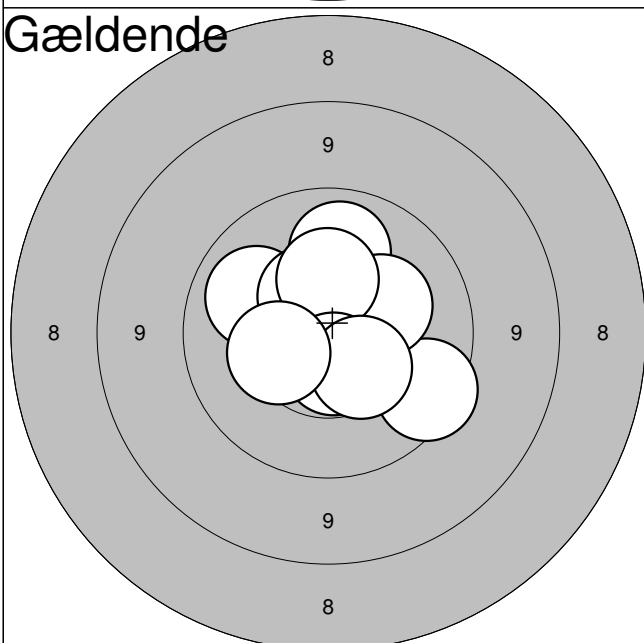

11:	10,7*	↗
12:	10,1	↗
13:	10,1	↑
14:	10,5	↗
15:	9,7	↘
16:	10,3	↗
17:	10,4	↑
18:	10,6*	↘
19:	10,4	↘
20:	10,4	↙

Serie: 99,0

Sum: 196,0

Jyllandsstævne 2011

Hold

62

Bane

4

Søren Otte

Hjørring Skytteforening

J2

Jyllandsstævne 2011 - riffel

Aalborg Skyttekreds

Prøveskud

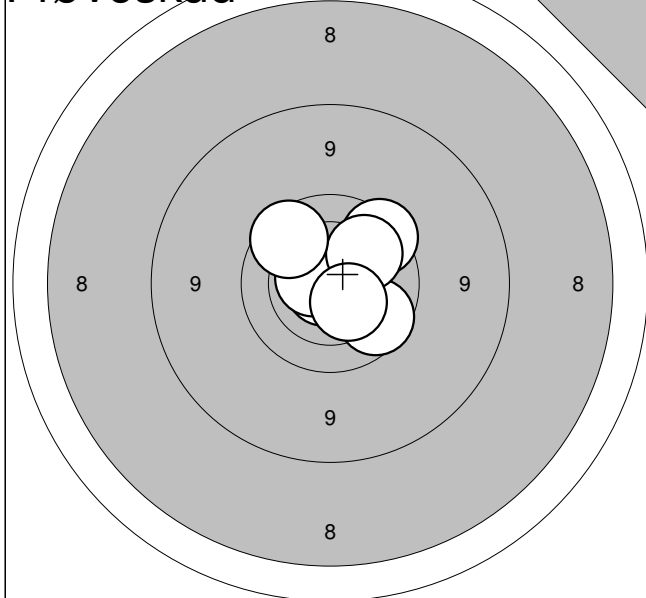

1:	9,9	↘
2:	9,8	↗
3:	10,8*	↙
4:	10,6*	↖
5:	10,1	↗
6:	9,9	↗
7:	10,4	↘

Serie: 67,0

Sum: 0,0

Gældende

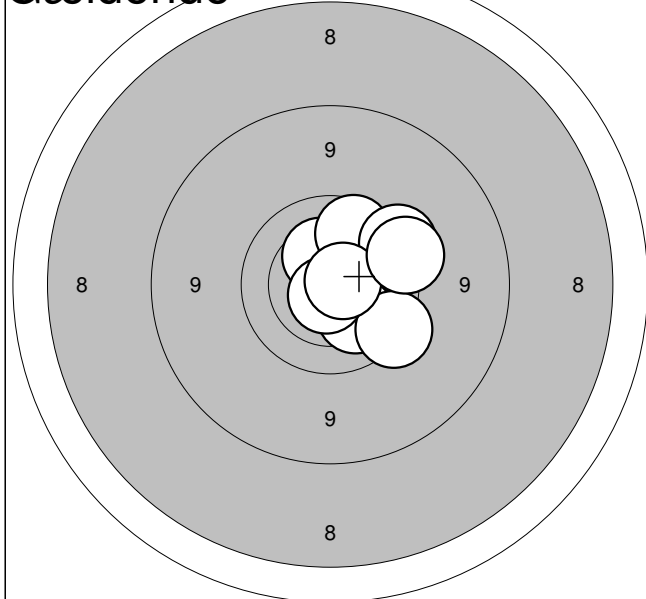

1:	10,5*	→
2:	10,6*	↗
3:	10,2	↘
4:	10,4	↗
5:	9,9	↗
6:	9,6	↘
7:	10,7*	↘
8:	9,6	↗
9:	10,7*	→
10:	9,6	→

Serie: 96,0

Sum: 96,0

Gældende

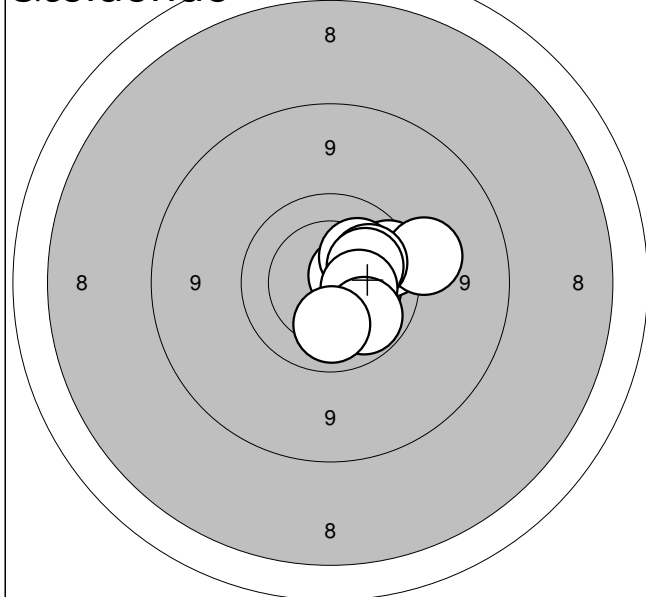

11:	10,6*	→
12:	10,3	→
13:	9,8	→
14:	9,4	→
15:	10,2	↗
16:	10,1	↗
17:	10,2	↗
18:	10,4	→
19:	10,0	↘
20:	10,1	↓

Serie: 98,0

Sum: 194,0

Jyllandsstævne 2011

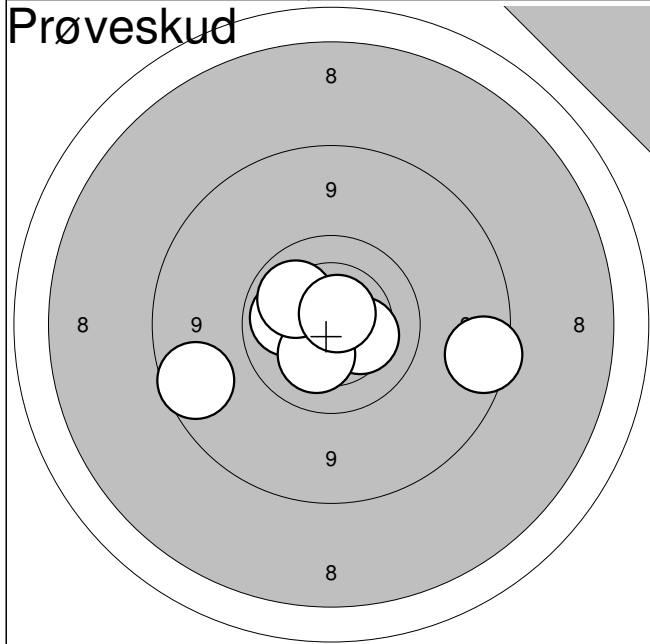

1:	8,9	↙
2:	10,3	→
3:	10,1	↙
4:	10,3	↘
5:	10,1	↗
6:	10,7*	↗
7:	8,8	→

Serie: 66,0

Sum: 0,0

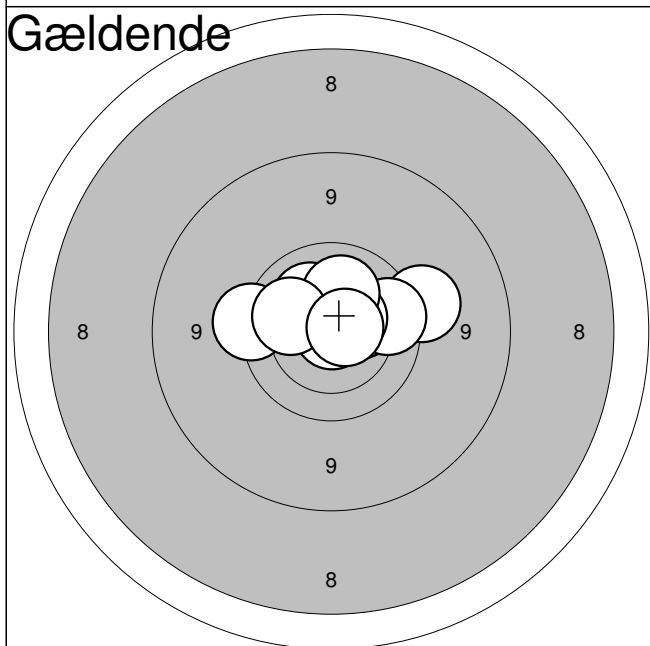

1:	9,5	→
2:	9,6	↙
3:	10,4	→
4:	10,9*	↗
5:	10,2	↗
6:	9,9	→
7:	10,5*	↗
8:	10,2	↑
9:	10,1	↙
10:	10,7*	→

Serie: 97,0

Sum: 97,0

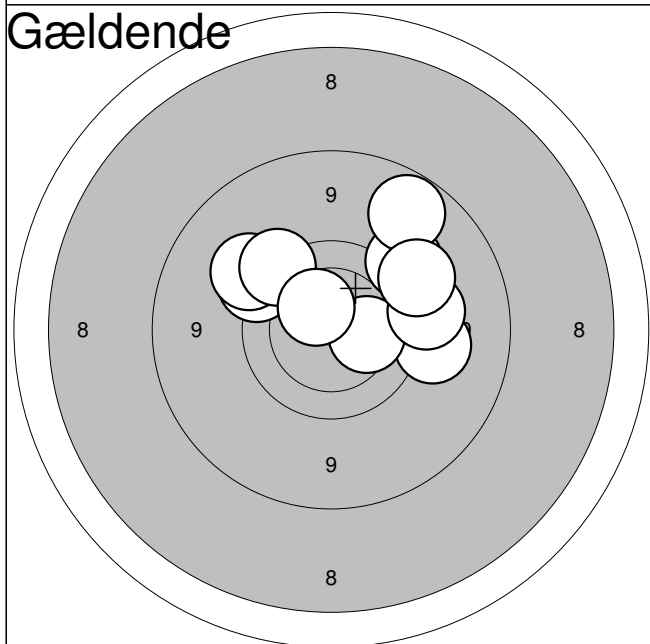

11:	9,4	→
12:	10,2	→
13:	9,4	↗
14:	9,6	↗
15:	9,4	↗
16:	9,4	→
17:	9,0	↗
18:	9,6	↗
19:	9,4	↗
20:	10,4	↗

Serie: 92,0

Sum: 189,0

Hold

62

Bane

6

Birgit Prior

D.F.B. Aalborg

V1

Jyllandsstævne 2011 - riffel

Aalborg Skyttekreds

Prøveskud

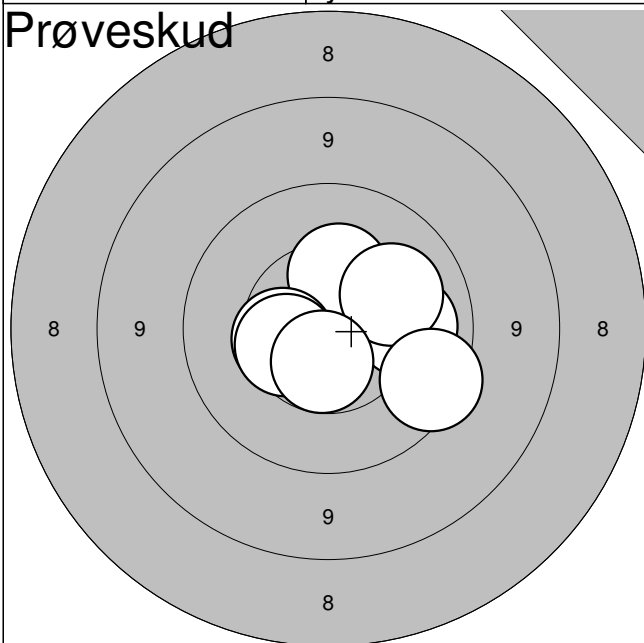

1:	10,1	→
2:	10,4	↑
3:	10,2	↗
4:	10,5	←
5:	10,5	←
6:	9,7	↘
7:	10,6*	↓

Serie: 69,0

Sum: 0,0

Gældende

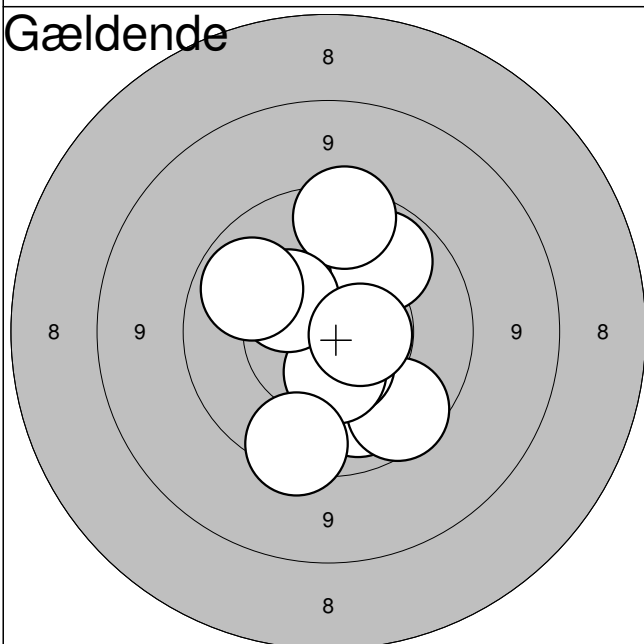

1:	10,1	↓
2:	9,8	↓
3:	10,6	↓
4:	10,0	↗
5:	9,7	↑
6:	10,5	↓
7:	9,7	↓
8:	10,4	↗
9:	10,0	↗
10:	10,6*	→

Serie: 97,0

Sum: 97,0

Gældende

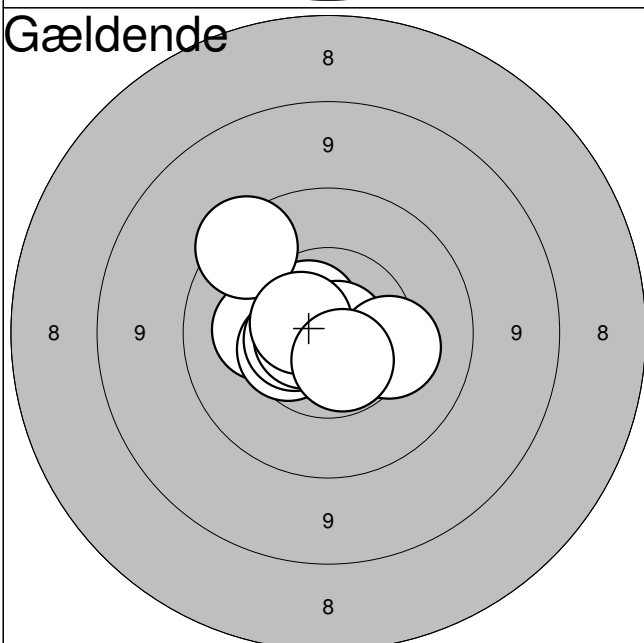

11:	10,3	←
12:	10,7*	↗
13:	10,9*	→
14:	9,7	↗
15:	10,5	←
16:	10,6*	←
17:	10,7*	←
18:	10,6*	↖
19:	10,3	→
20:	10,6*	↓

Serie: 99,0

Sum: 196,0

Jyllandsstævne 2011

Hold

62

Bane

7

Allan Prior

D.F.B. Aalborg

V1

Jyllandsstævne 2011 - riffel

Aalborg Skyttekreds

Prøveskud

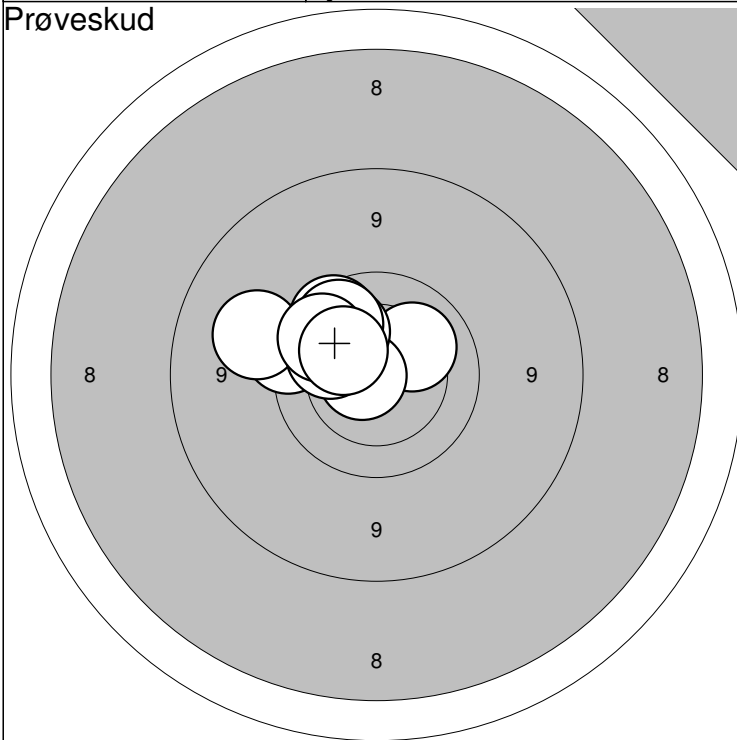

Prøveskud

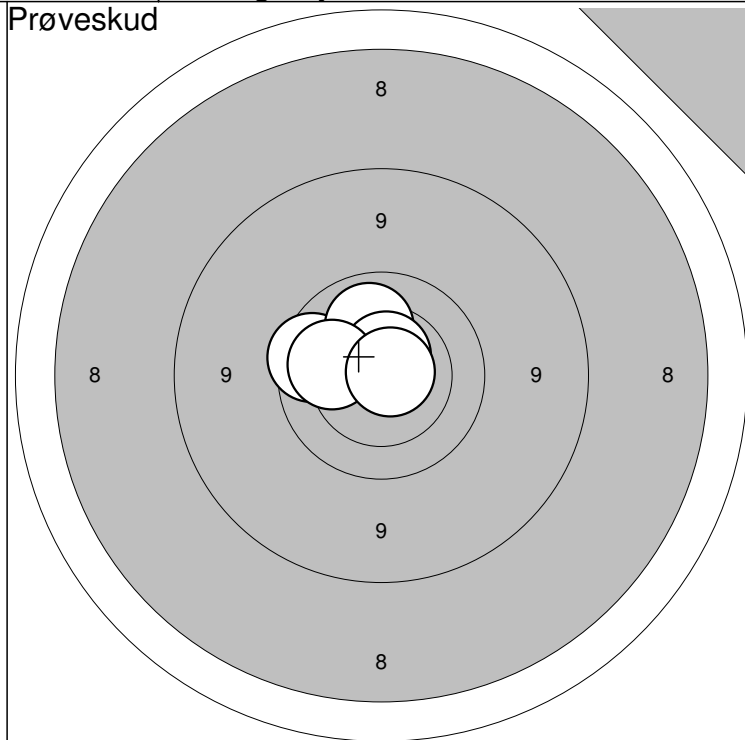

1:10,2 ↗

2: 9,8 ↗

3: 9,6 ↖

4:10,7* ↖

5:10,1 ↗

6: 9,9 ↗

7: 9,3 ↖

8:10,1 ↗

9: 9,9 ↗

10:10,3 ↗

Serie: 95,0

Sum: 0,0

11: 9,8 ↖

12:10,1 ↗

13:10,6* ↗

14:10,1 ↖

15:10,8* ↗

Serie: 49,0

Sum: 0,0

Gældende

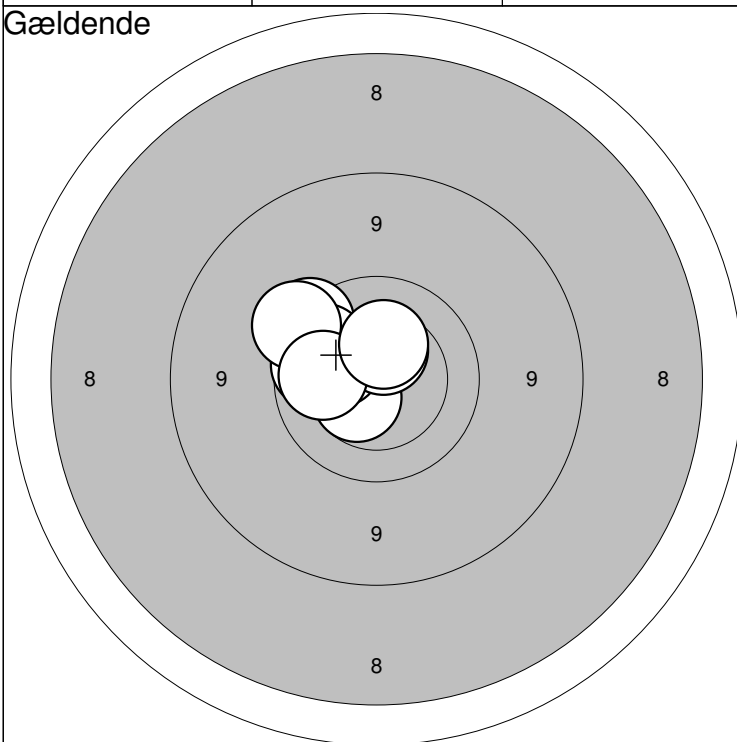

Gældende

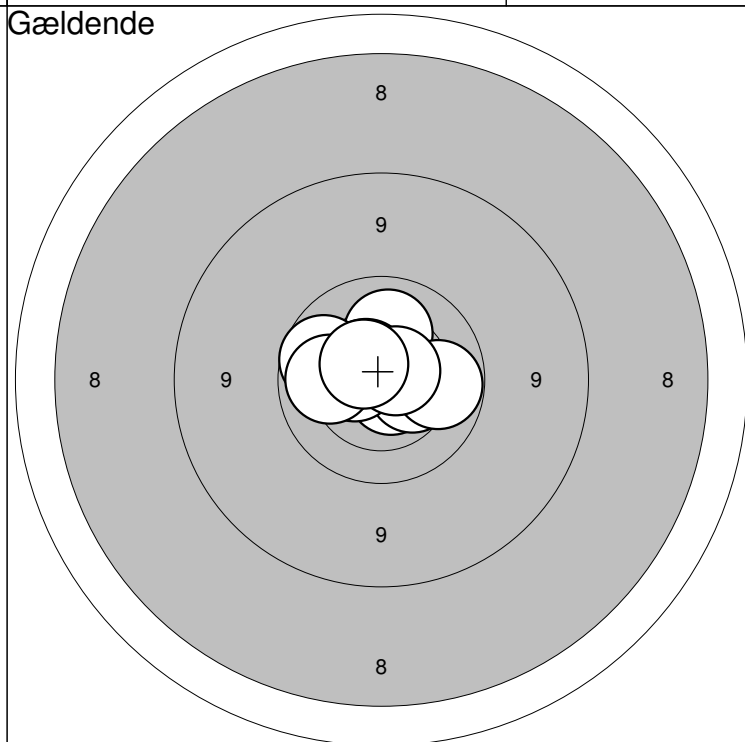

1:10,5* ↖

2: 9,9 ↖

3:10,2 ↖

4: 9,9 ↖

5: 9,7 ↗

6: 9,9 ↗

7: 9,6 ↗

8:10,5 ↗

9:10,0 ↖

10:10,4 ↗

Serie: 95,0

Sum: 95,0

11:10,2 ↗

12:10,6* ↗

13:10,7* ↘

14:10,4 ↗

15:10,0 ↗

16:10,5* ↖

17: 9,9 ↖

18:10,7* ↗

19:10,1 ↖

20:10,6* ↗

Serie: 99,0

Sum: 194,0

Jyllandsstævne 2011

Hold
62Bane
8**Niels H. Overgaard**

Skytteklubben DSB/ASF

UNG

Jyllandsstævne 2011 - riffel

Aalborg Skyttekreds

Prøveskud

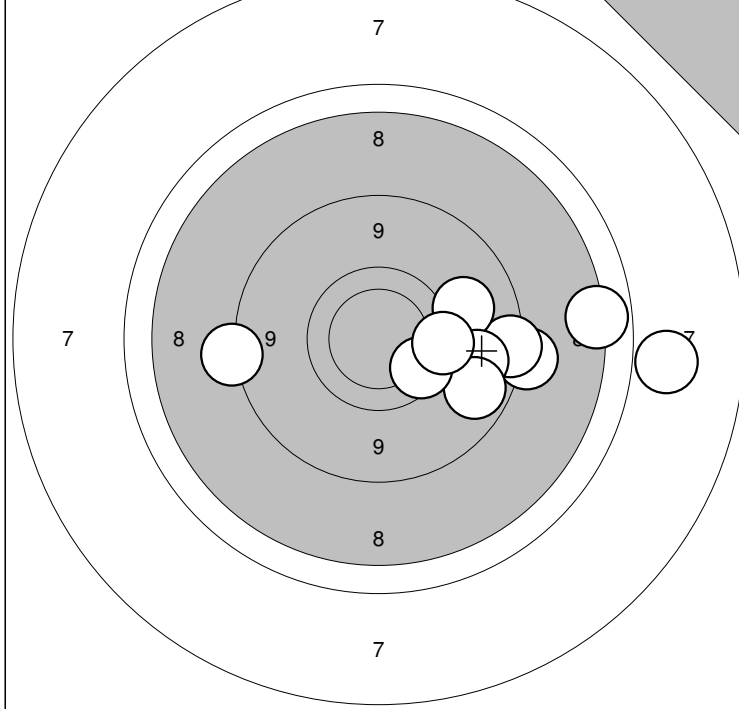

Prøveskud

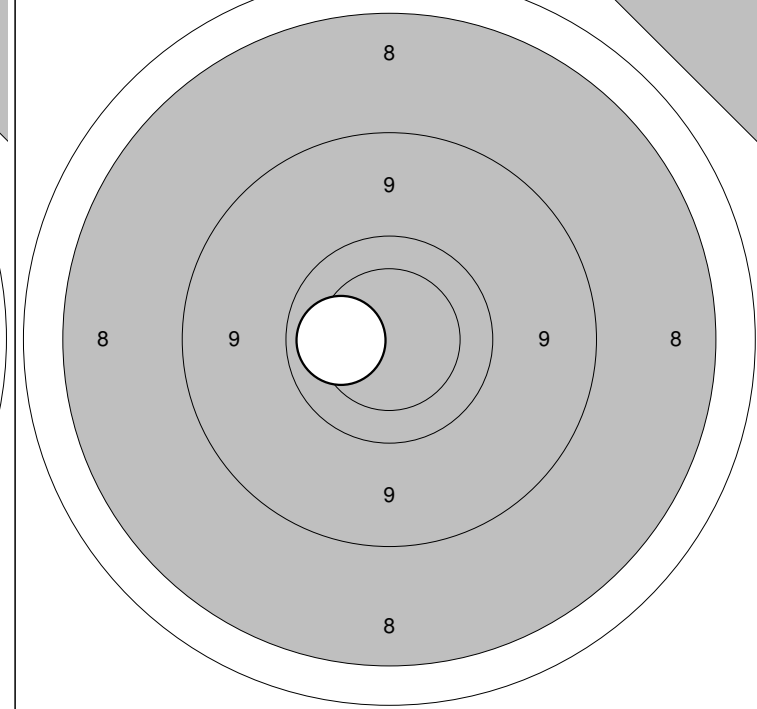

1: 8,6 ←	6: 9,3 →	Serie: 84,0
2: 7,4 →	7: 9,1 →	
3: 8,0 →	8: 9,0 ↘	Sum: 0,0
4: 8,6 →	9: 9,8 ↘	
5: 8,8 →	10: 9,6 →	

11: 10,1 ←	Serie: 10,0
	Sum: 0,0

Gældende

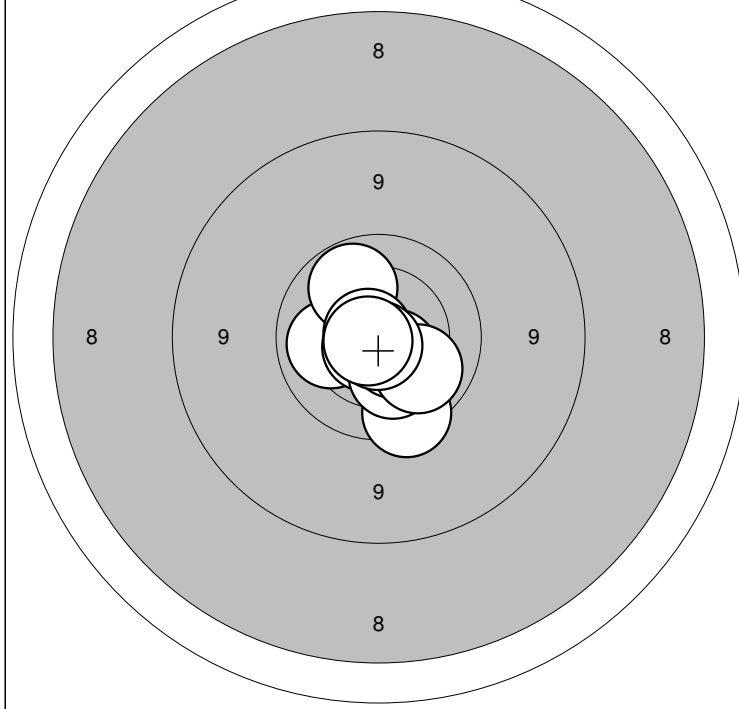

Gældende

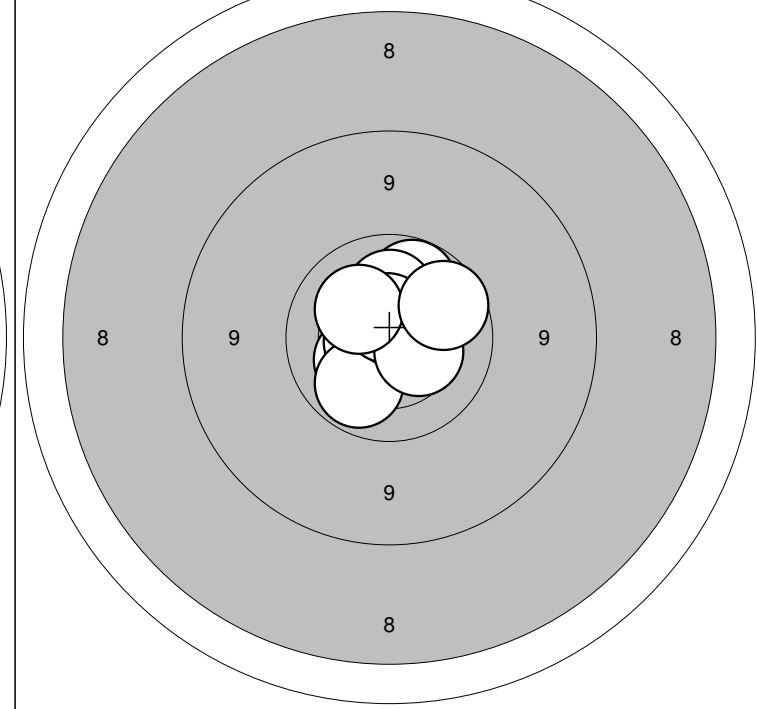

1: 10,1 ←	6: 10,8* ←	Serie: 99,0
2: 9,7 ↘	7: 10,6* ↘	
3: 10,7* ↙	8: 10,1 ↘	Sum: 99,0
4: 10,3 ↘	9: 10,8* ↘	
5: 10,0 ↗	10: 10,8* ←	

11: 10,3 ←	16: 10,2 ↑	Serie: 99,0
12: 10,6* ←	17: 10,6* ↑	
13: 10,0 ↙	18: 10,4 →	Sum: 198,0
14: 10,7* ↗	19: 10,2 ↗	
15: 10,0 ↗	20: 9,9 →	

Hold
62Bane
9**Annette Munkbøl**

Aalborg Skyttekreds

ÅK1

Jyllandsstævne 2011 - riffel

Aalborg Skyttekreds

Prøveskud

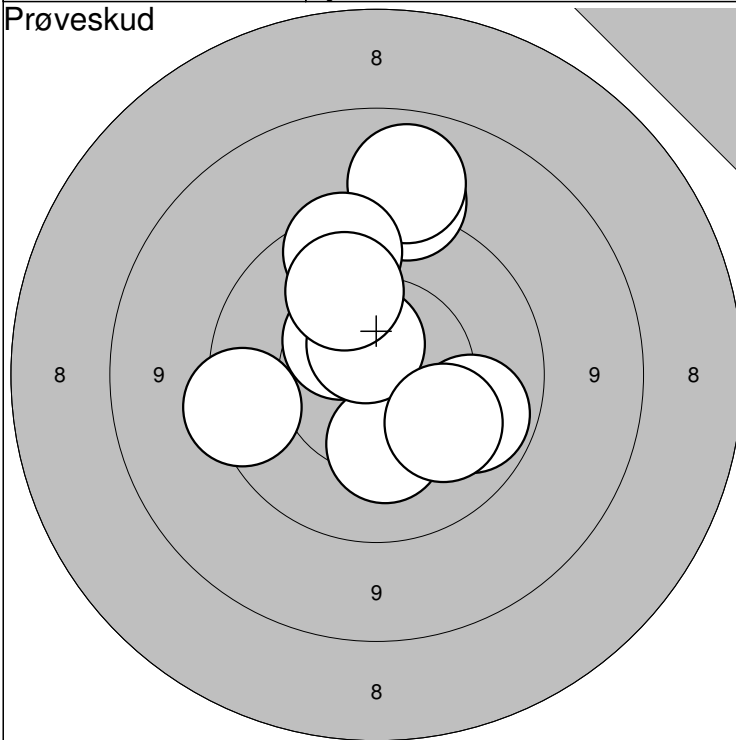

Prøveskud

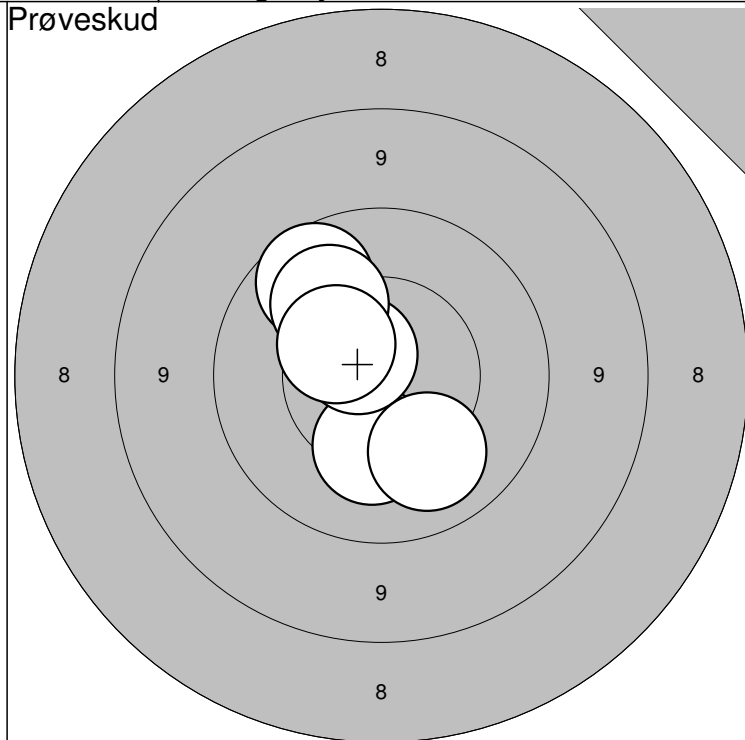

1: 9,3

↑

6:10,0

→

Serie: 96,0

2: 9,1

↑

7: 9,7

←

11:10,3

↓

16:10,5

↖

Serie: 59,0

3: 9,8

↑

8:10,7*

↑

13:10,7*

↑

Sum: 0,0

4:10,5

↗

9:10,1

↗

14:10,1

↓

Sum: 0,0

5:10,3

↓

10:10,2

↘

15:10,1

↗

Gældende

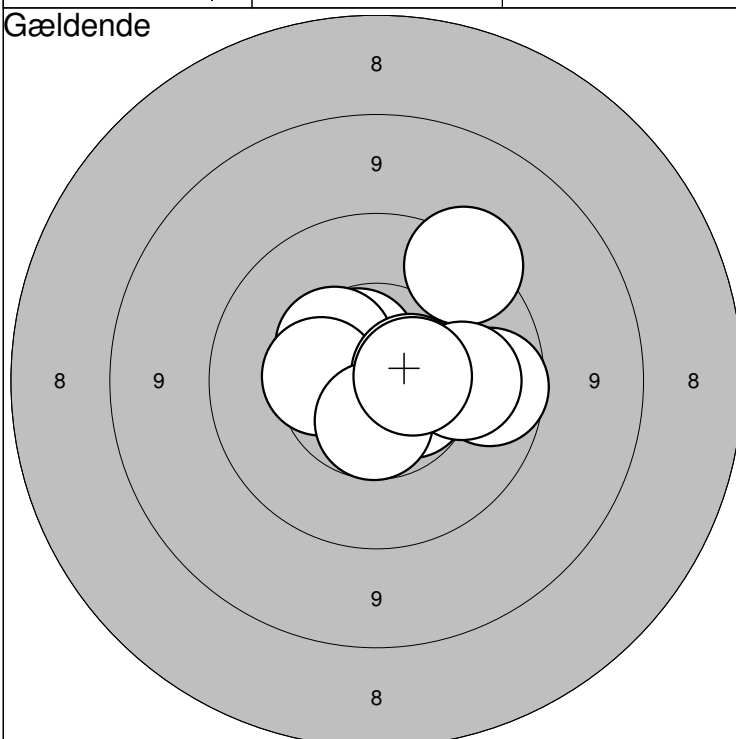

Gældende

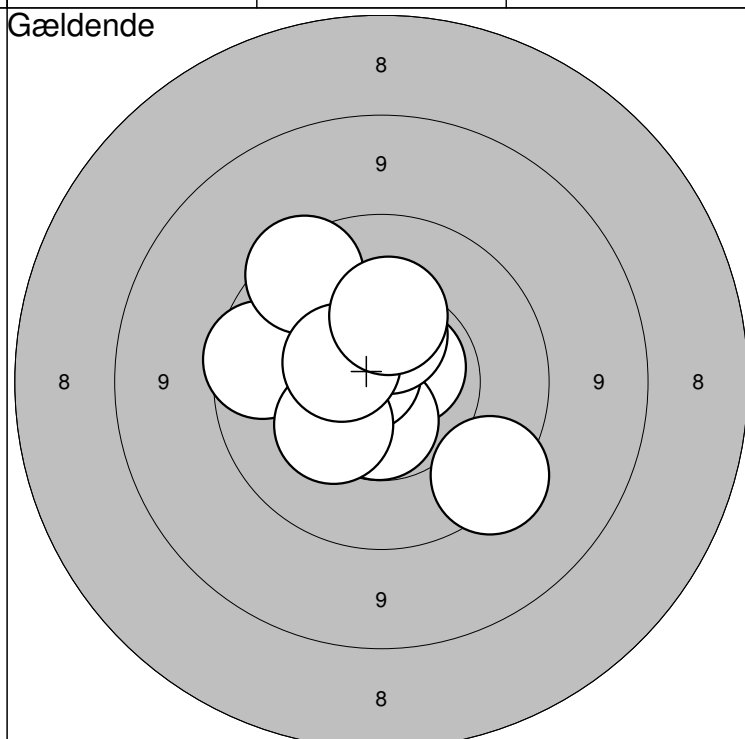

1:10,6*

↗

6:10,6*

→

Serie: 98,0

2: 9,6

↗

7:10,6*

→

11:10,7*

↗

16:10,5

↑

Serie: 97,0

3:10,5

↗

8:10,6

↓

13: 9,8

←

17:10,4

↘

Sum: 195,0

4:10,4

←

9:10,2

→

14:10,8*

↖

18: 9,6

↓

5: 9,9

→

10:10,6*

→

15: 9,7

↗

19:10,5

↖

Jyllandsstævne 2011

Hold
62Bane
10**Jeppe V. Kristensen**

Aalborg Skyttekreds

1

Jyllandsstævne 2011 - riffel

Aalborg Skyttekreds

Prøveskud

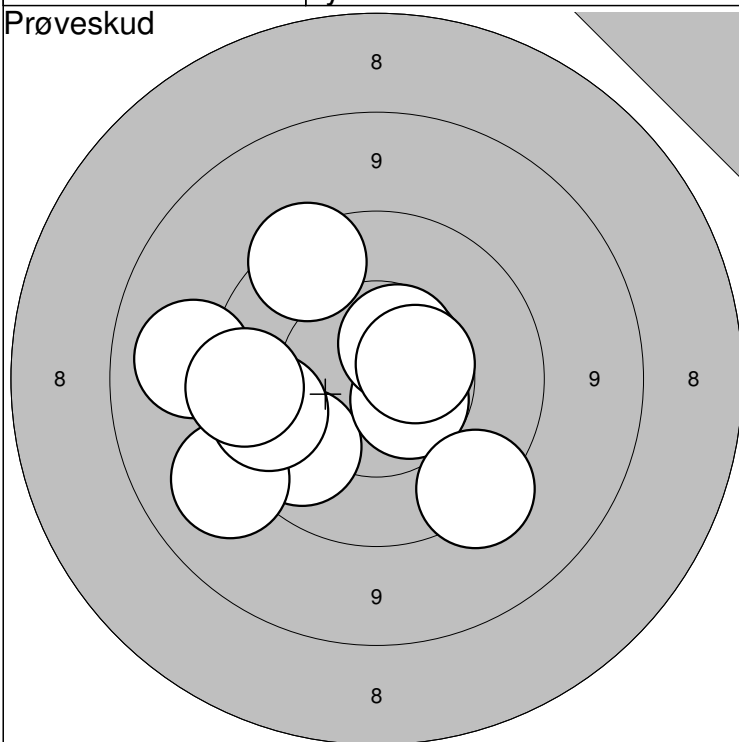

Prøveskud

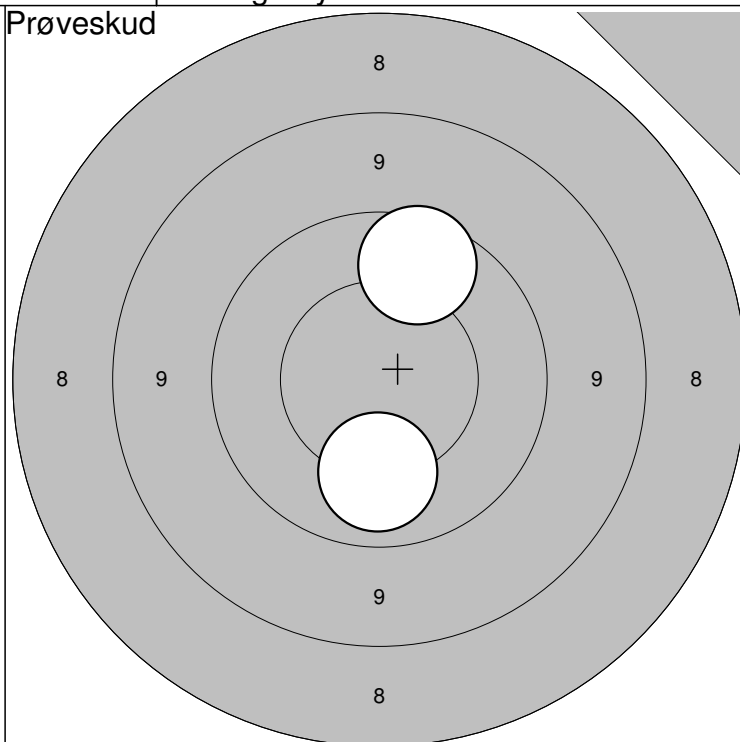

1:10,0 ↙

6: 9,7 ↗

Serie: 94,0

2:10,6* ↘

7: 9,3 ↙

3: 9,6 ↘

8: 9,9 ←

4:10,6 ↗

9: 9,2 ←

5:10,6 →

10: 9,7 ←

Sum: 0,0

11: 9,8 ↗

12:10,1 ↘

Serie: 19,0

Sum: 0,0

Gældende

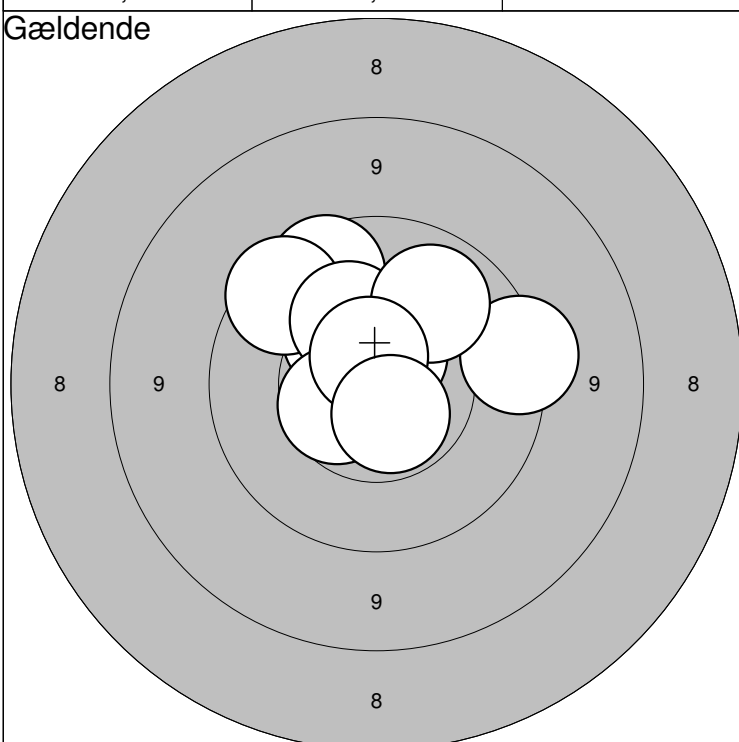

Gældende

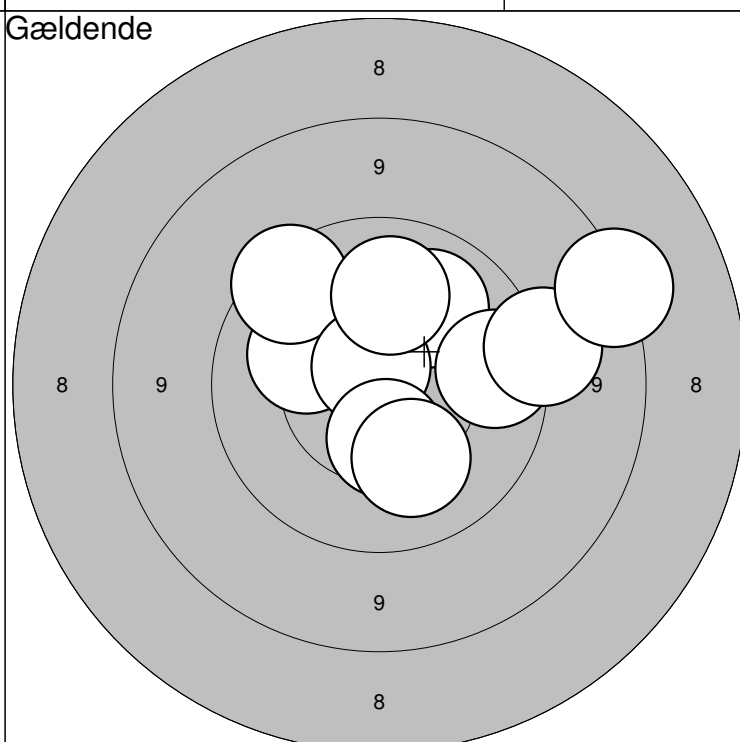

1:10,7* ↗

6: 9,6 →

Serie: 97,0

2:10,4 ↗

7:10,1 ↗

3: 9,8 ↗

8:10,5 ←

4: 9,8 ↗

9:10,7* ↗

5:10,3 ↗

10:10,6* ↘

Sum: 97,0

11:10,1 ↗

16: 9,4 →

Serie: 95,0

12: 9,9 →

17:10,5 ↘

13:10,2 ←

18:10,1 ↗

14: 9,7 ↗

19:10,2 ↘

15:10,8* ↗

20: 8,5 →

Sum: 192,0

Jyllandsstævne 2011

Hold

62

Bane

11

Gitte Bertelsen

Hobro Egnens Skytteforening

BK2

Jyllandsstævne 2011 - riffel

Aalborg Skyttekreds

Prøveskud

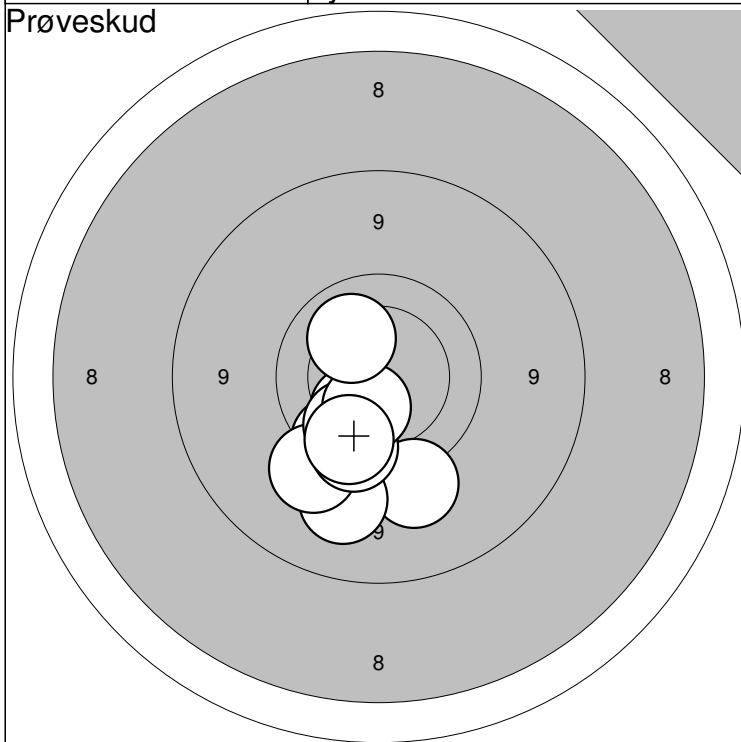

Prøveskud

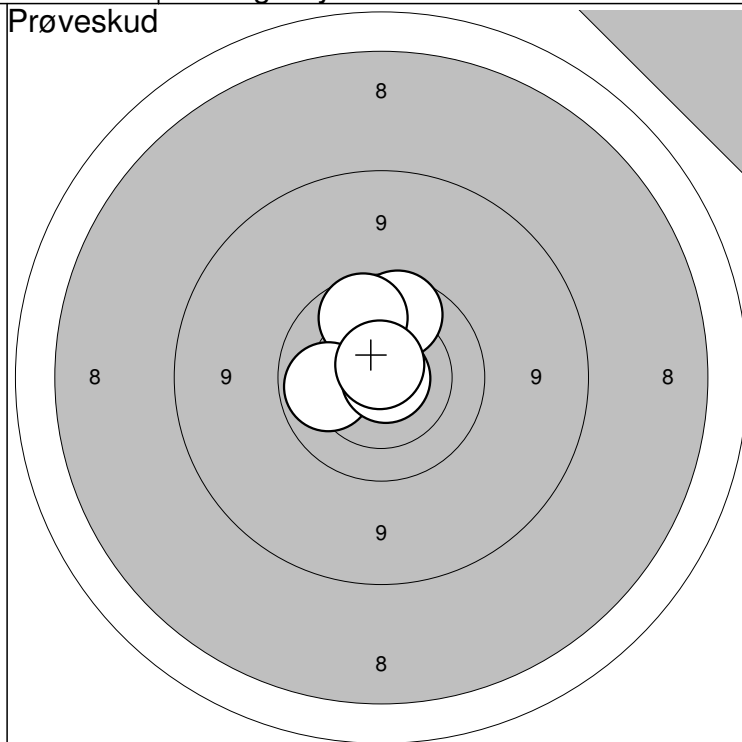

1: 9,4



6: 9,8



Serie: 94,0

2: 9,3



7: 10,0



3: 9,8



8: 10,4



4: 9,4



9: 9,8



5: 10,3



10: 10,2



Sum: 0,0

11: 9,9



16: 10,7*



Serie: 58,0

12: 10,6*



13: 9,9



14: 10,0



15: 10,9*



Sum: 0,0

Gældende

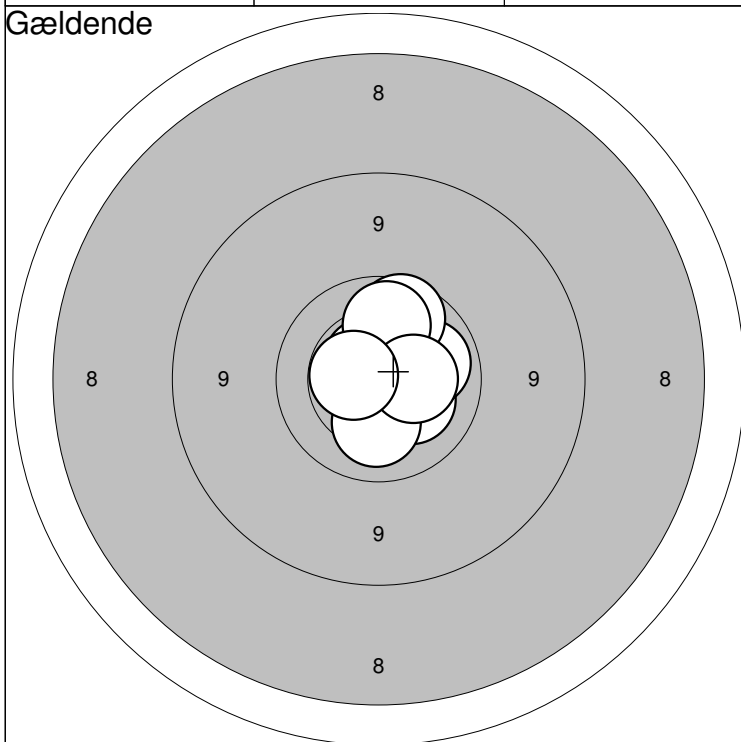

Gældende

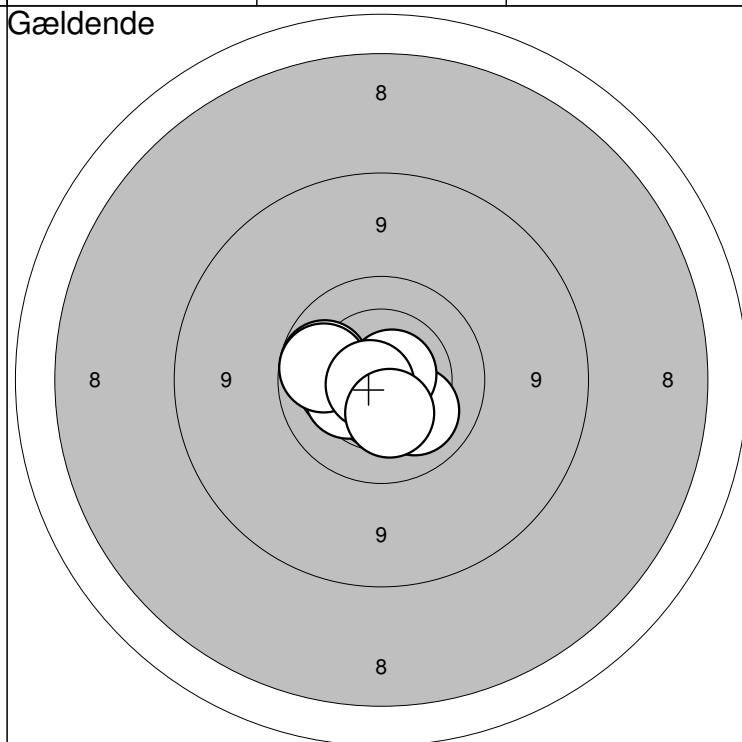

1: 10,7*



6: 10,1



Serie: 99,0

2: 10,3



7: 9,9



3: 10,6*



8: 10,0



4: 10,3



9: 10,4



5: 10,2



10: 10,5*



Sum: 99,0

11: 10,3



16: 10,0



Serie: 100,0

12: 10,5*



17: 10,2



13: 10,4



18: 10,7*



14: 10,6*



19: 10,7*



15: 10,0



20: 10,4



Sum: 199,0

Jyllandsstævne 2011

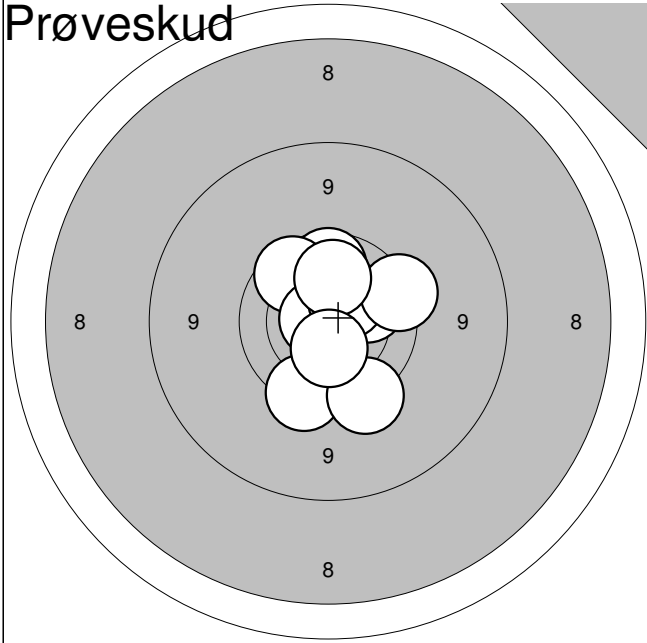

1:	9,7	↓
2:	9,6	↓
3:	9,9	↑
4:	10,1	→
5:	9,9	↖
6:	10,7*	←
7:	10,4	↗
8:	9,7	→
9:	10,1	↑
10:	10,4	↓

Serie: 95,0

Sum: 0,0

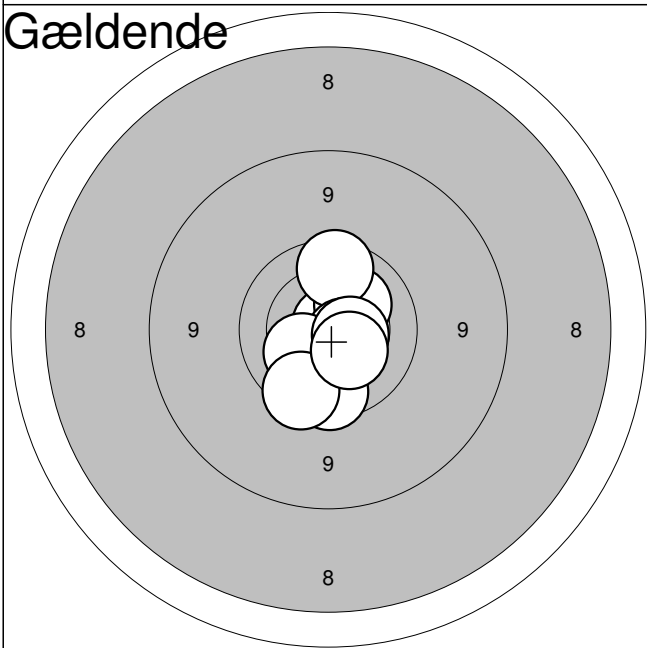

1:	10,8*	↗
2:	10,3	↗
3:	9,8	↑
4:	10,6*	→
5:	10,3	↓
6:	9,8	↓
7:	10,3	↙
8:	9,8	↓
9:	10,5*	→
10:	10,4	↘

Serie: 97,0

Sum: 97,0

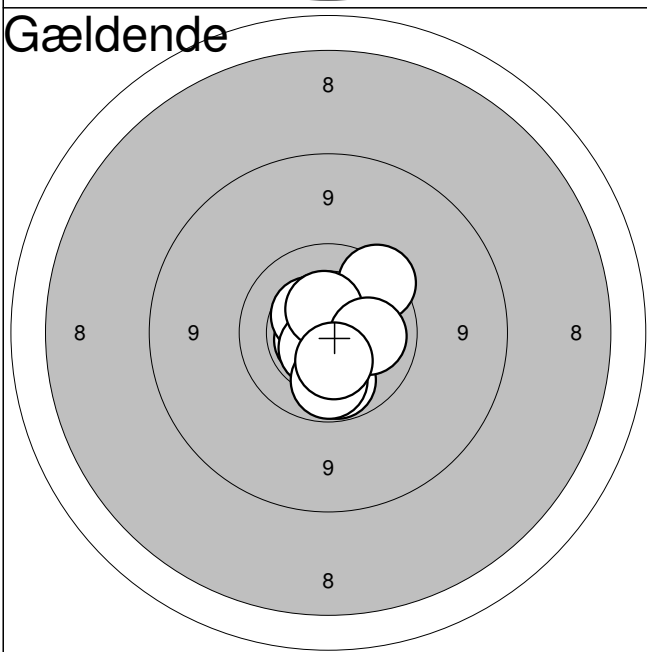

11:	10,0	↓
12:	10,6*	←
13:	10,8*	↗
14:	10,5	↖
15:	9,7	↗
16:	10,6*	↓
17:	10,0	↓
18:	10,5	↑
19:	10,2	→
20:	10,4	↓

Serie: 99,0

Sum: 196,0

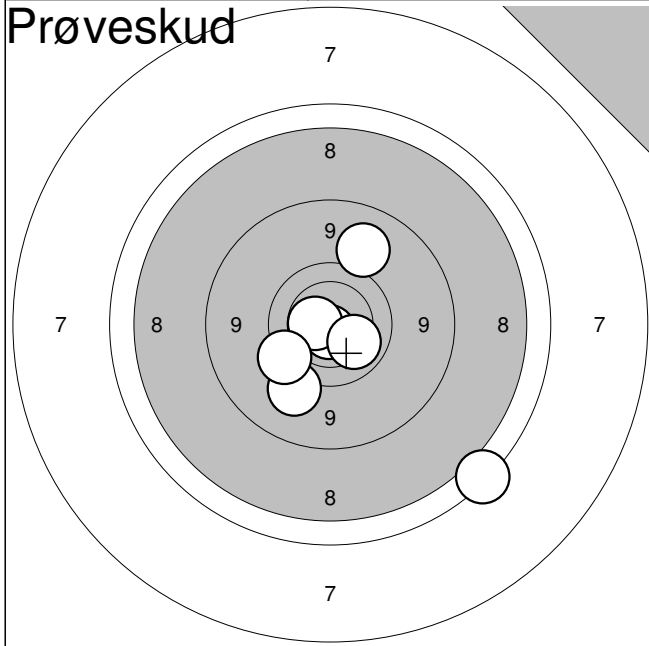

1:	7,7	↘
2:	9,3	↘
3:	10,7*	↓
4:	10,5*	←
5:	9,2	↗
6:	9,6	↙
7:	10,1	↘

Serie: 64,0

Sum: 0,0

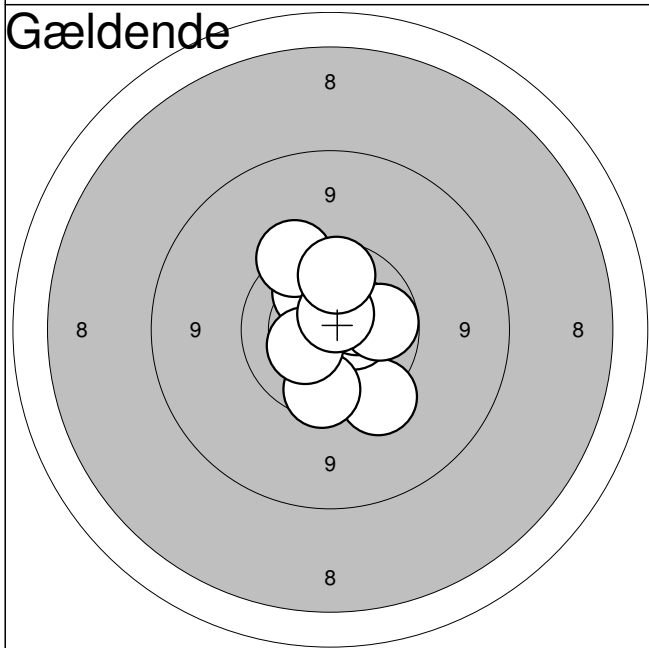

1:	9,6	↘
2:	10,5	→
3:	9,8	↓
4:	10,1	↗
5:	10,4	→
6:	9,6	↗
7:	10,0	→
8:	10,4	↙
9:	10,6*	↗
10:	9,9	↗

Serie: 96,0

Sum: 96,0

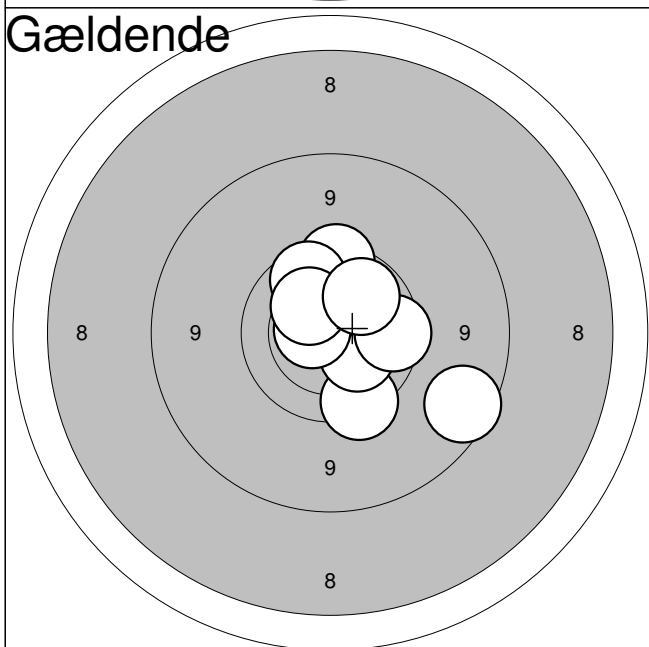

11:	9,7	↗
12:	9,7	↘
13:	10,3	↘
14:	10,4	↗
15:	8,9	↘
16:	9,9	↗
17:	10,6*	←
18:	9,8	→
19:	10,3	↗
20:	10,0	↗

Serie: 94,0

Sum: 190,0

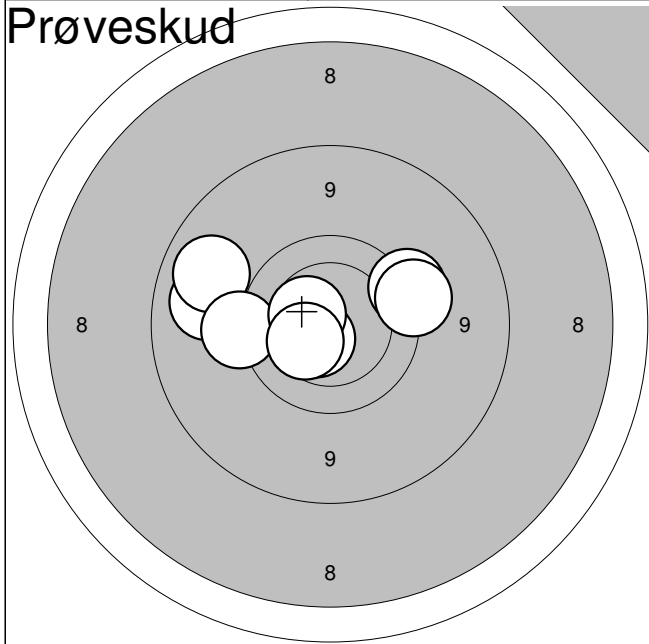

1:	9,1	←
2:	9,1	←
3:	9,6	→
4:	9,5	←
5:	10,6*	↓
6:	9,5	→
7:	10,5	←
8:	10,4	↓

Serie:	75,0
Sum:	0,0

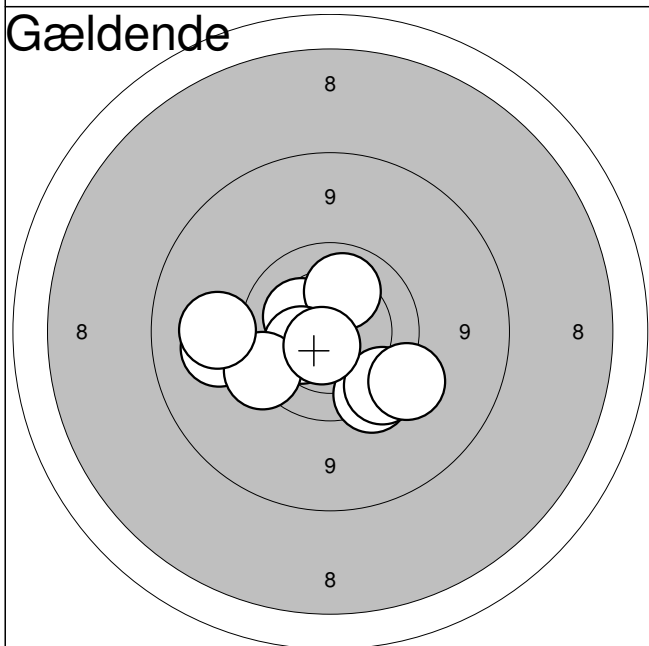

1:	10,3	↖
2:	9,3	←
3:	9,7	↓
4:	10,1	↑
5:	10,3	←
6:	9,7	←
7:	9,7	↓
8:	9,5	↓
9:	9,3	←
10:	10,6*	↓

Serie:	94,0
Sum:	94,0

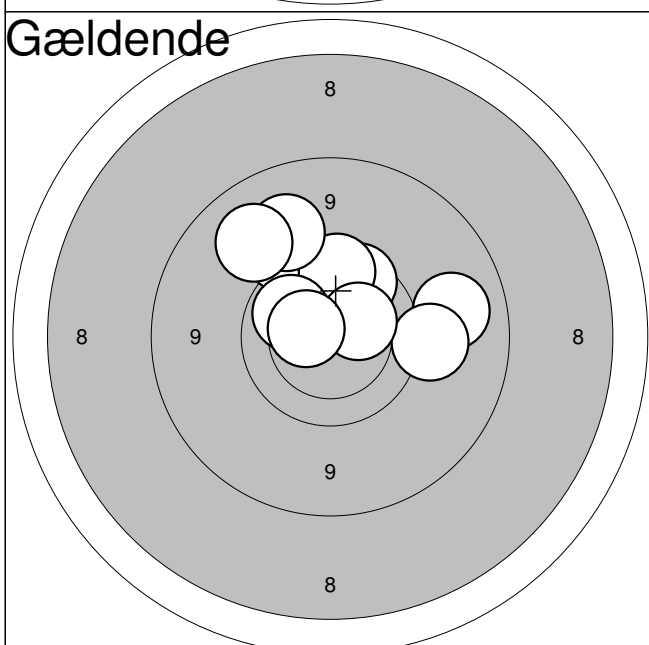

11:	9,8	↗
12:	9,4	↗
13:	9,8	↑
14:	9,1	→
15:	9,3	↑
16:	9,4	→
17:	10,3	↗
18:	9,2	↗
19:	10,1	↗
20:	10,5	←

Serie:	93,0
Sum:	187,0

Hold

63

Bane

3

Rasmus M. Larsen

Vilsted Skf.

ÅK1

Jyllandsstævne 2011 - riffel

Aalborg Skyttekreds

Prøveskud

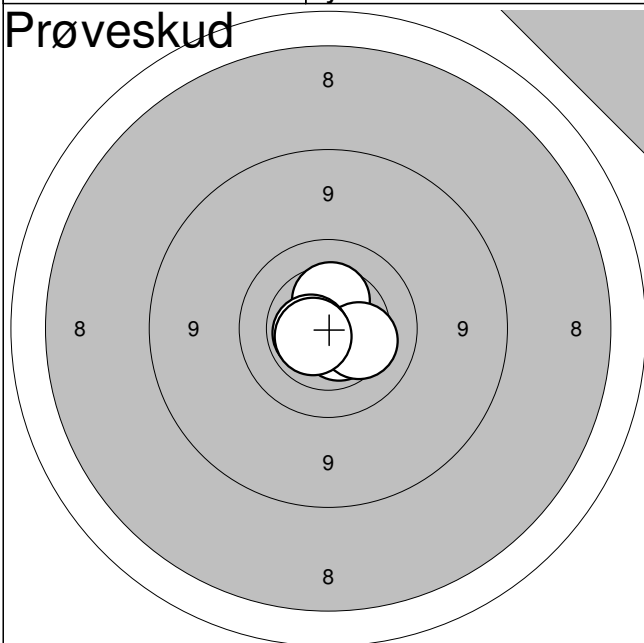

1: 10,8*

←

2: 10,6*

↘

3: 10,4

↑

4: 10,3

→

5: 10,6*

←

6: 10,6*

↙

Serie:

60,0

Sum:

0,0

Gældende

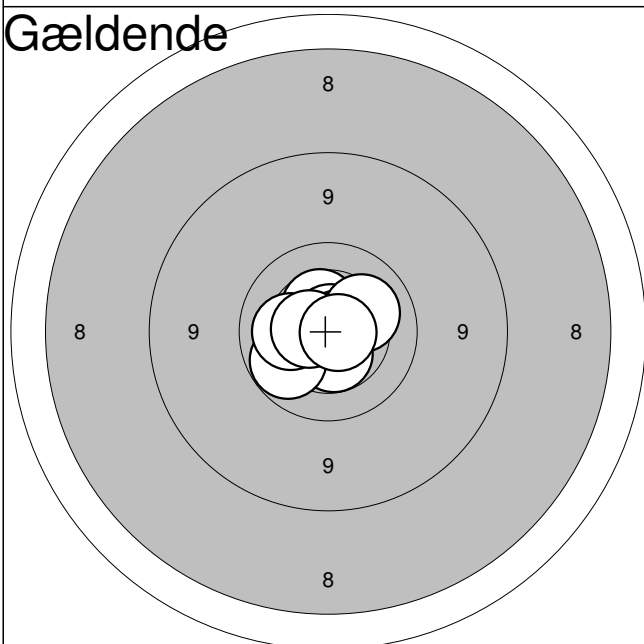

1: 10,8*

↘

2: 10,5

↑

3: 10,5*

↘

4: 10,8*

↑

5: 10,0

↙

6: 10,2

←

7: 10,7*

→

8: 10,6*

←

9: 10,2

↗

10: 10,7*

→

Serie:

100,0

Sum:

100,0

Gældende

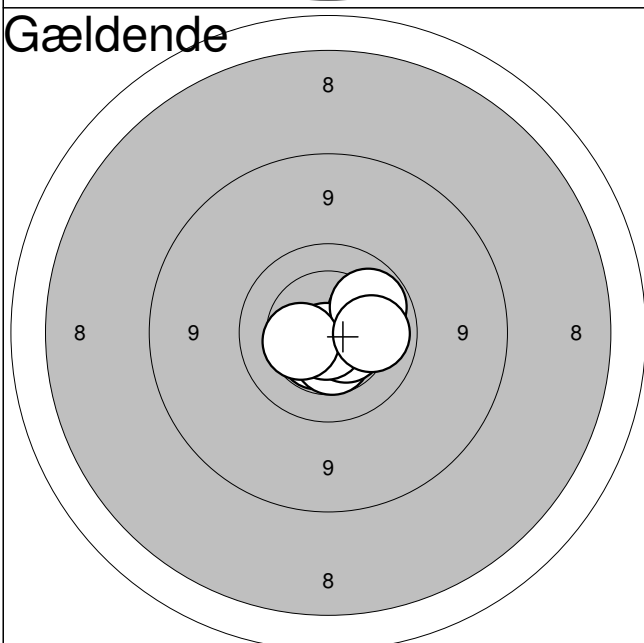

11: 10,6*

↘

12: 10,5*

↘

13: 10,1

↗

14: 10,5

↘

15: 10,3

→

16: 10,5*

↘

17: 10,8*

↘

18: 10,0

↗

19: 10,4

←

20: 10,1

→

Serie:

100,0

Sum:

200,0

Jyllandsstævne 2011

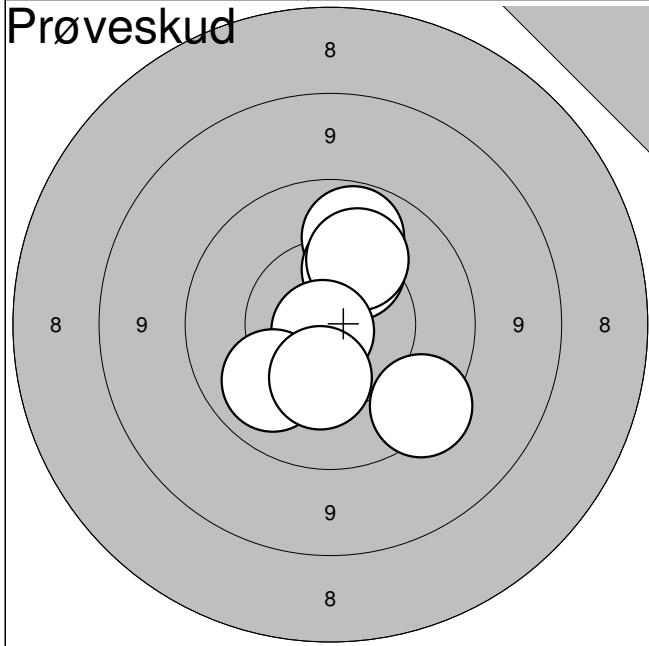

1:	10,0	↑
2:	10,3	↑
3:	10,2	↑
4:	9,6	↓
5:	10,8*	↓
6:	10,1	↓
7:	10,4	↓

Serie:	69,0
Sum:	0,0

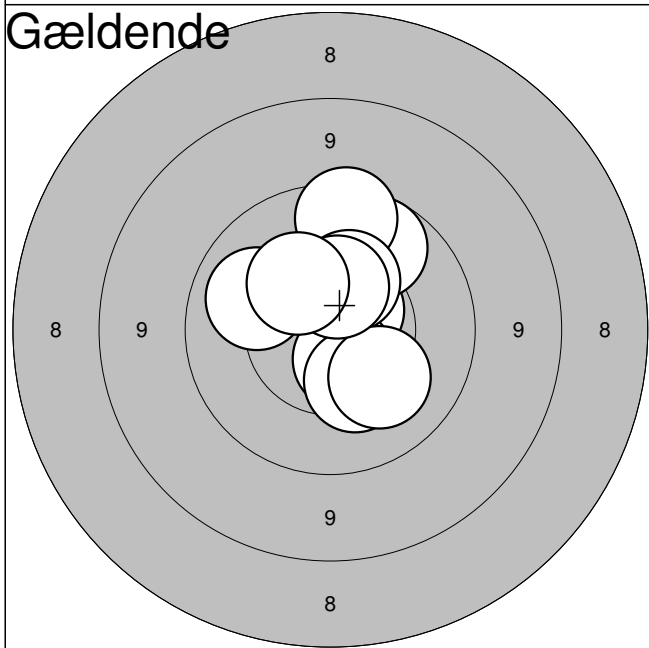

1:	10,6*	↗
2:	10,0	↑
3:	10,6*	↓
4:	9,7	↑
5:	10,3	↓
6:	10,4	↑
7:	10,2	↓
8:	10,1	←
9:	10,5	↑
10:	10,4	↗

Serie:	99,0
Sum:	99,0

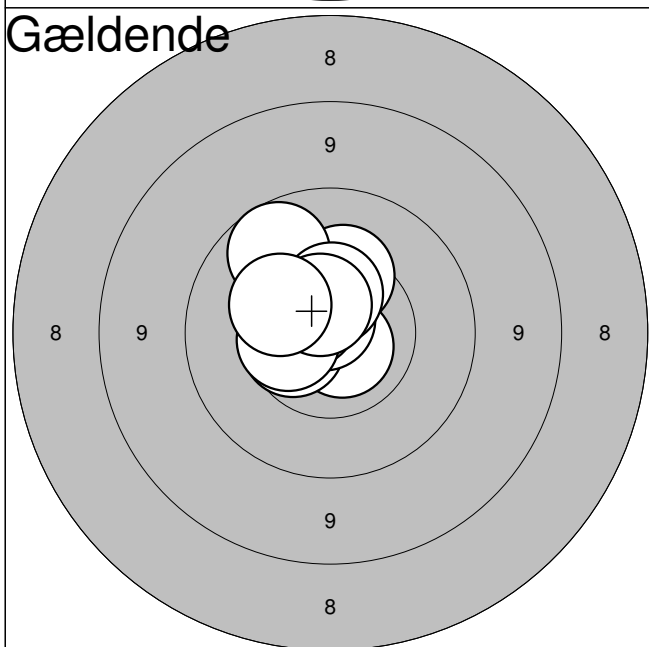

11:	10,8*	↓
12:	10,5	←
13:	10,8*	↑
14:	10,7*	↗
15:	10,5	←
16:	10,3	↑
17:	10,0	↗
18:	10,5	↑
19:	10,6*	↑
20:	10,3	↗

Serie:	100,0
Sum:	199,0

Hold
63Bane
5**Jens Arne Abildgaard**

Hobro Egnens Skytteforening

ÅK2

Jyllandsstævne 2011 - riffel

Aalborg Skyttekreds

Prøveskud

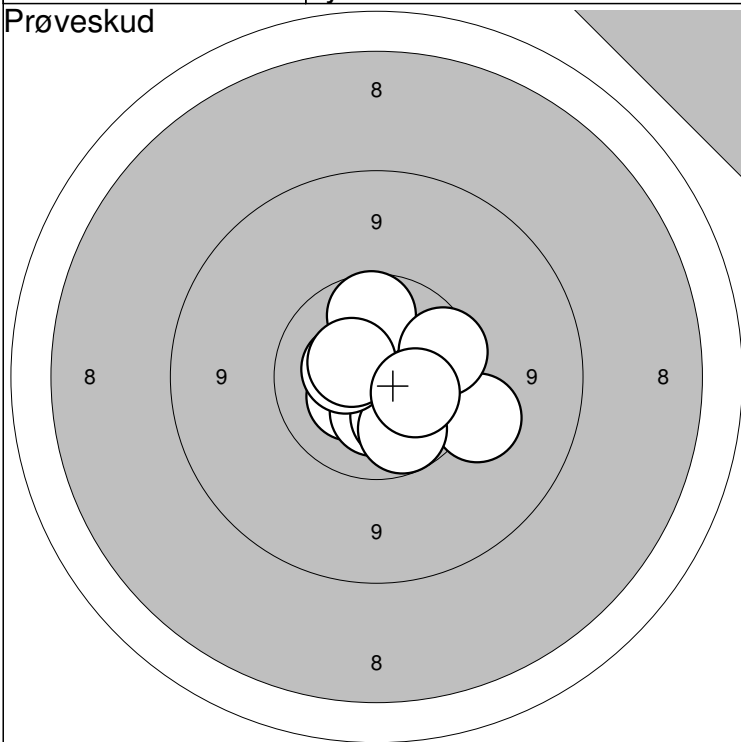

Prøveskud

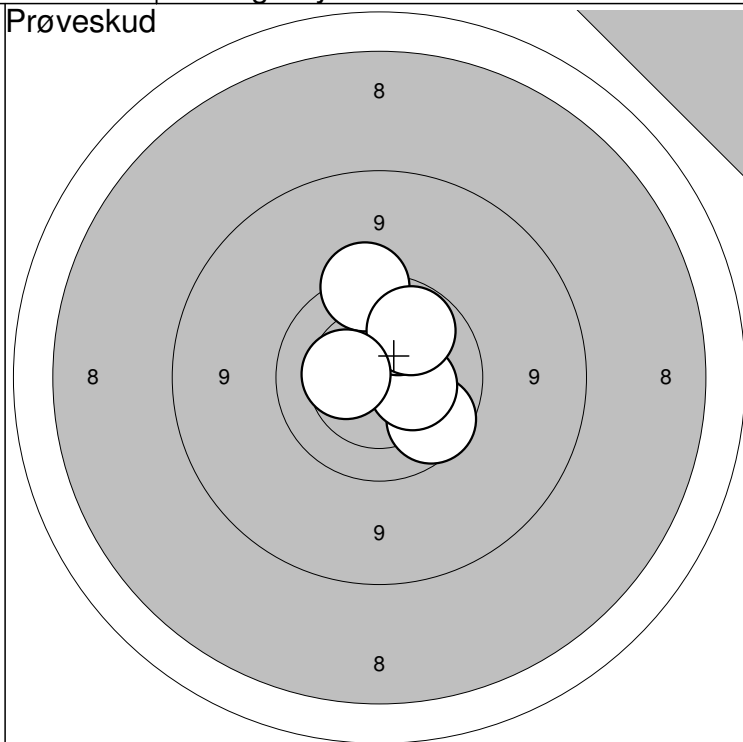

1:10,4 ↙

2:10,4 ↓

3:10,2 ↘

4: 9,5 →

5: 9,9 ↓

6: 9,9 ↑

7:10,4 ←

8: 9,8 →

9:10,5 ↖

10:10,2 →

Serie:

96,0

Sum:

0,0

11: 9,9 ↘

12:10,4 →

13:10,1 ↑

14: 9,6 ↑

15:10,0 ↗

16:10,4 ←

Serie:

58,0

Sum:

0,0

Gældende

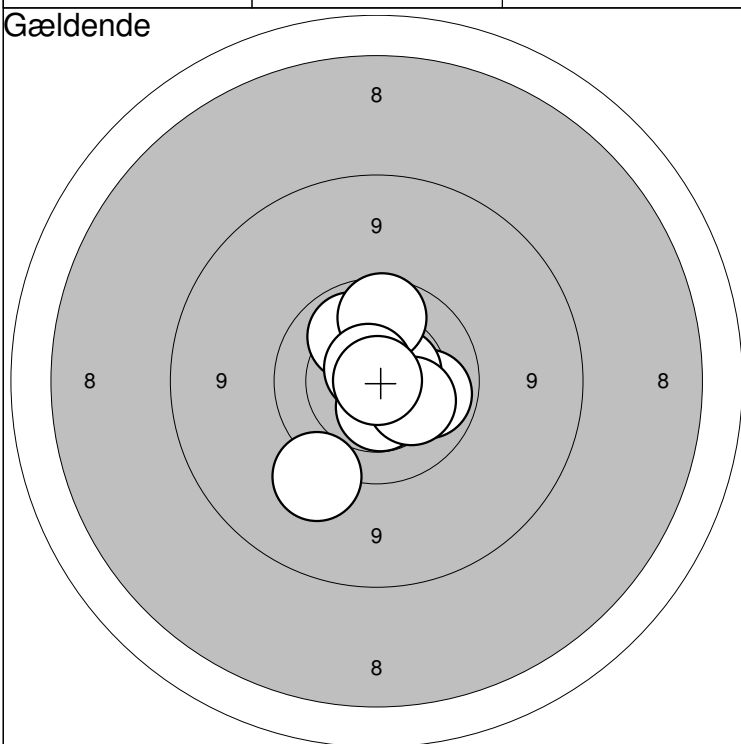

Gældende

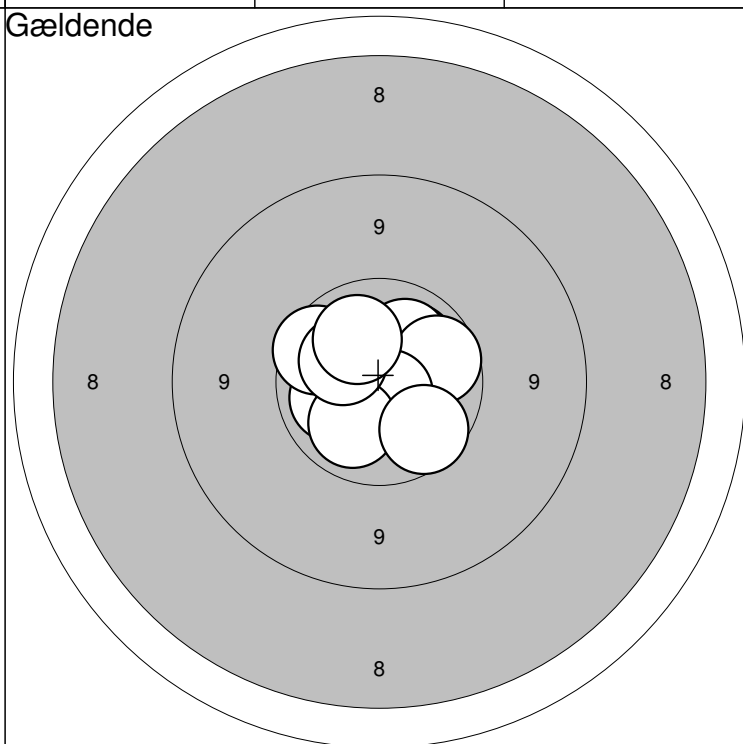

1:10,1 ↗

2:10,6* →

3:10,1 →

4:10,6* →

5: 9,4 ↘

6: 9,9 ↑

7:10,5* ↓

8:10,3 ↘

9:10,7* ↗

10:10,9* →

Serie:

98,0

Sum:

98,0

11:10,2 ↗

12:10,2 ↗

13: 9,9 →

14:10,1 ←

15:10,7* ↘

16:10,1 ↘

17: 9,9 ↖

18:10,2 ↖

19:10,2 ↗

20: 9,9 ↘

Serie:

97,0

Sum:

195,0

Jyllandsstævne 2011

Vilsted Skf.

ÅK2

Jyllandsstævne 2011 - riffel

Aalborg Skyttekreds

Prøveskud

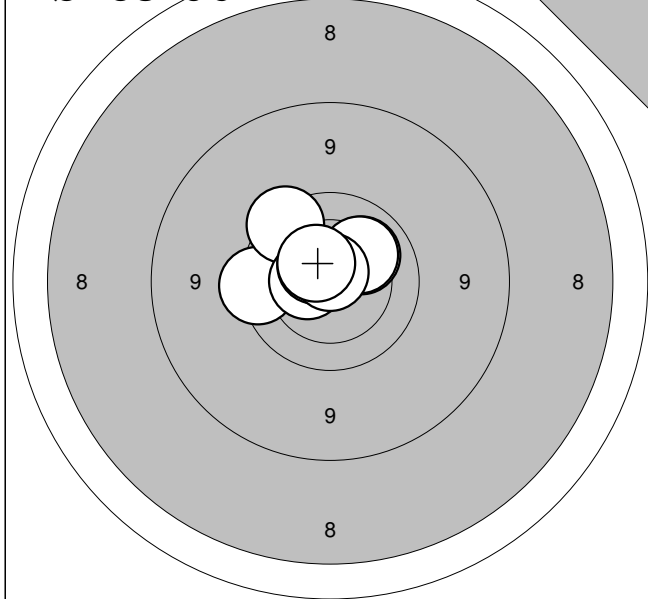

1:	10,1	↗
2:	9,7	←
3:	9,7	↗
4:	10,5*	←
5:	10,2	↗
6:	10,5*	↗
7:	10,8*	↑
8:	10,5*	↗

Serie: 78,0

Sum: 0,0

Gældende

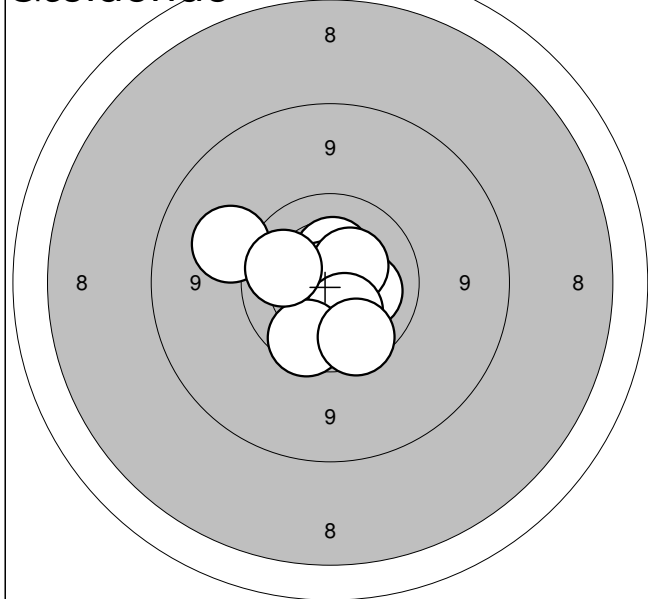

1:	9,3	←
2:	10,4	↑
3:	10,7*	→
4:	10,8*	↗
5:	10,3	→
6:	10,4	↗
7:	10,3	↓
8:	9,9	↓
9:	10,0	←
10:	9,8	↓

Serie: 97,0

Sum: 97,0

Gældende

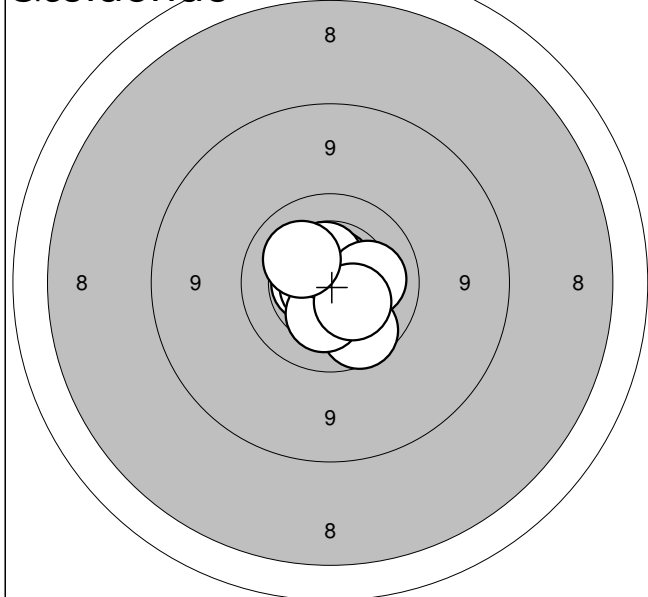

11:	10,6*	←
12:	10,7*	↑
13:	10,8*	↓
14:	10,7*	←
15:	9,9	↓
16:	10,3	↓
17:	10,5*	↑
18:	10,2	→
19:	10,4	↓
20:	10,2	↗

Serie: 99,0

Sum: 196,0

Hold
63Bane
7**Niels H. Overgaard**

Skytteklubben DSB/ASF

UNG

Jyllandsstævne 2011 - riffel

Aalborg Skyttekreds

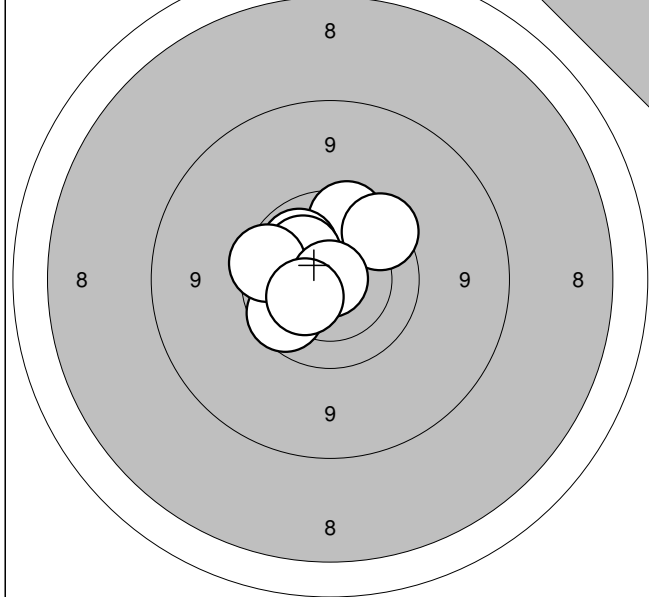
Prøveskud

1:	9,8	↑
2:	9,9	↙
3:	10,1	↗
4:	9,8	↘
5:	10,3	↖
6:	10,2	↗
7:	9,8	↖
8:	10,9*	↖
9:	10,4	↘

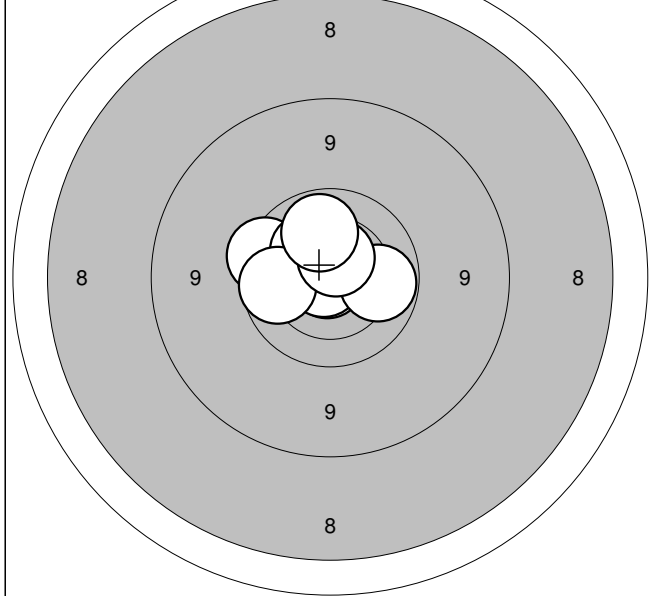
Serie: 86,0**Sum: 0,0****Gældende**

1:	9,8	↖
2:	10,9*	↙
3:	10,5*	↗
4:	10,5*	↗
5:	10,3	↗
6:	10,8*	↖
7:	9,9	↖
8:	10,0	→
9:	10,5*	↗
10:	10,1	↗

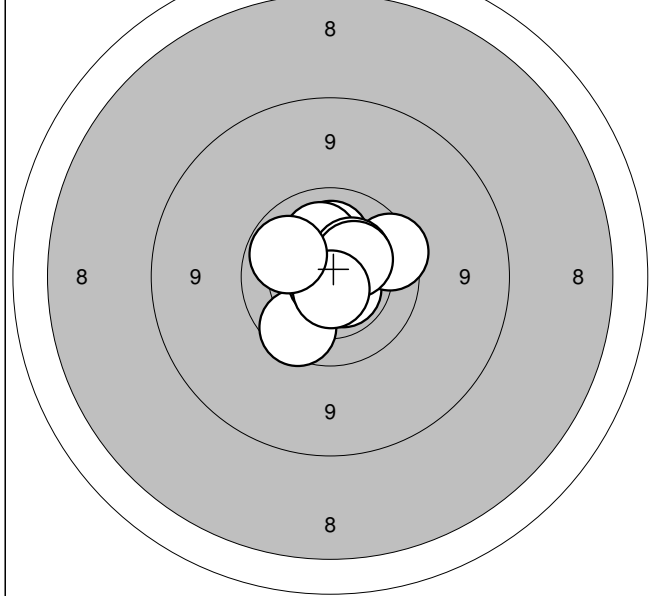
Serie: 98,0**Sum: 98,0****Gældende**

11:	10,6*	↘
12:	10,2	↑
13:	9,8	→
14:	10,2	↑
15:	9,8	↙
16:	10,8*	↙
17:	10,4	↗
18:	10,4	↗
19:	10,7*	↓
20:	10,0	↖

Serie: 98,0**Sum: 196,0**

Jyllandsstævne 2011

Hold

63

Bane

8

Karsten Abildgaard

Hobro Egnens Skytteforening

ÅK1

Jyllandsstævne 2011 - riffel

Aalborg Skyttekreds

Prøveskud

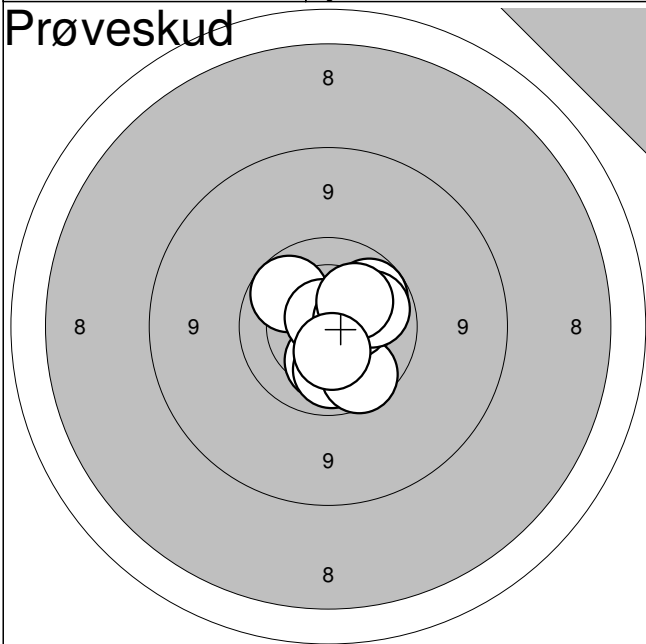

1:	10,0	↗
2:	10,3	↓
3:	10,1	↓
4:	9,9	↘
5:	10,7*	↗
6:	10,5	→
7:	10,0	↗
8:	10,0	→
9:	10,2	↗
10:	10,5	↓

Serie: 99,0

Sum: 0,0

Gældende

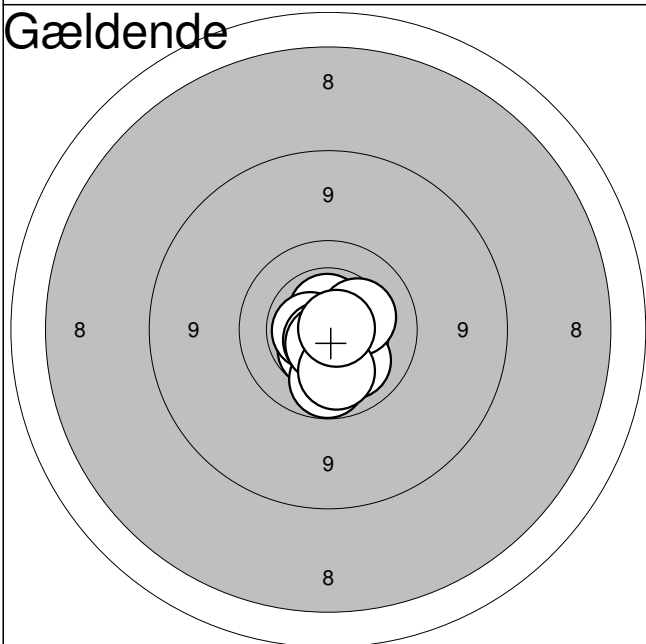

1:	10,6*	↑
2:	10,5*	↓
3:	10,2	↓
4:	10,0	↓
5:	10,6*	←
6:	10,7*	↘
7:	10,3	→
8:	10,7*	↓
9:	10,1	↓
10:	10,8*	→

Serie: 100,0

Sum: 100,0

Gældende

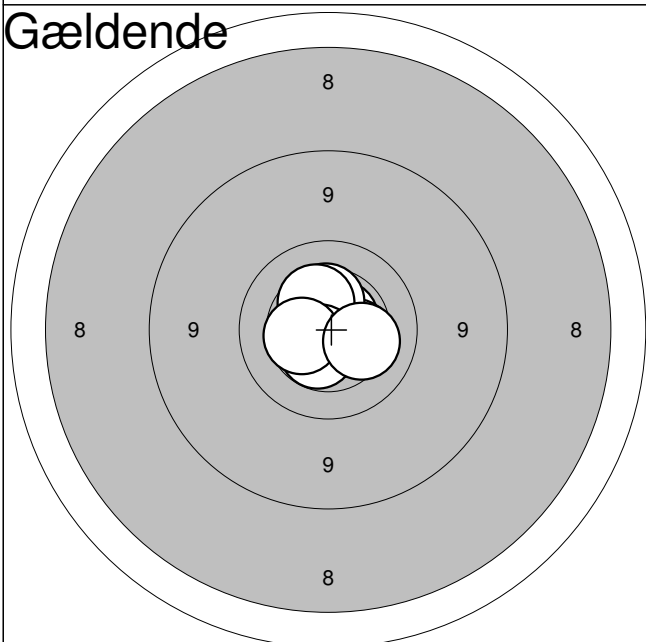

11:	10,7*	↗
12:	10,6*	↗
13:	10,4	→
14:	10,7*	↘
15:	10,4	↑
16:	10,4	↗
17:	10,6*	↘
18:	10,5*	↘
19:	10,4	←
20:	10,3	↘

Serie: 100,0

Sum: 200,0

Jyllandsstævne 2011

Hold
63Bane
9**Frede Kristensen**

Aalborg Skyttekreds

ÅK1

Jyllandsstævne 2011 - riffel

Aalborg Skyttekreds

Prøveskud

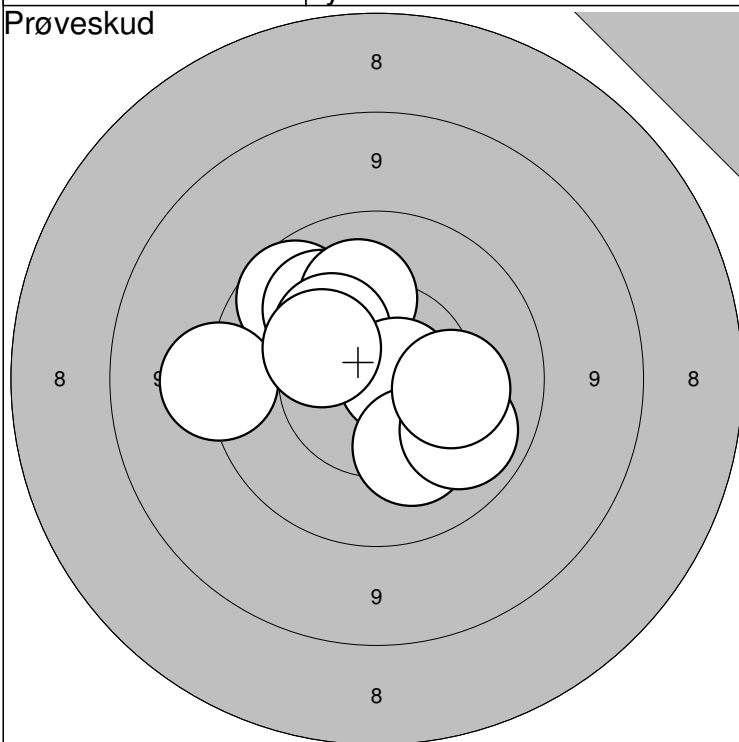

Prøveskud

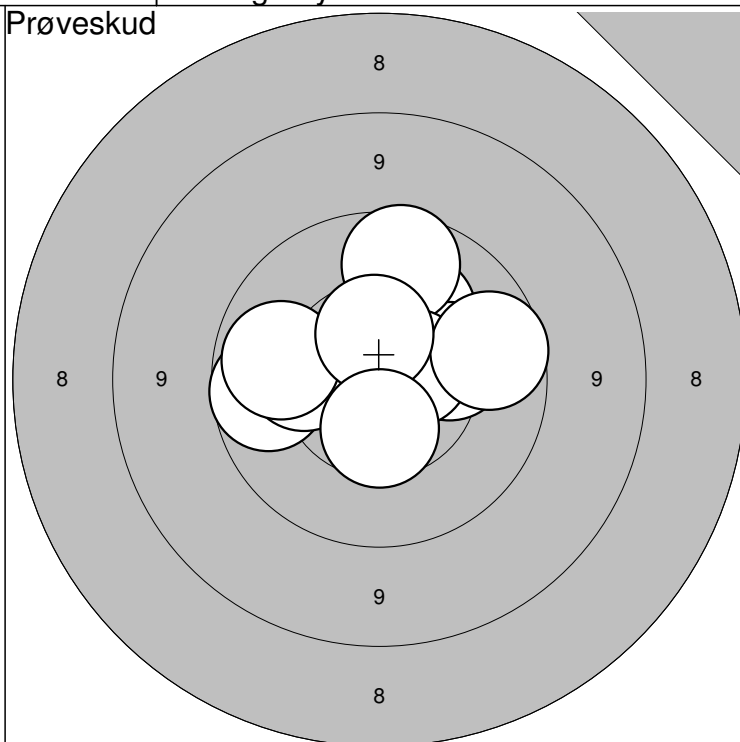

1: 9,9 ↗

2: 10,1 ↗

3: 10,2 ↑

4: 10,4 ↗

5: 10,8* →

6: 10,2 ↓

7: 10,1 ↓

8: 10,3 →

9: 9,5 ←

10: 10,4 ↖

Serie: 98,0

Sum: 0,0

11: 10,2 ↗

12: 10,3 →

13: 9,9 ↑

14: 10,6* →

15: 9,9 ←

16: 10,3 ←

17: 9,9 →

18: 10,0 ←

19: 10,5 ↑

20: 10,5 ↓

Serie: 97,0

Sum: 0,0

Gældende

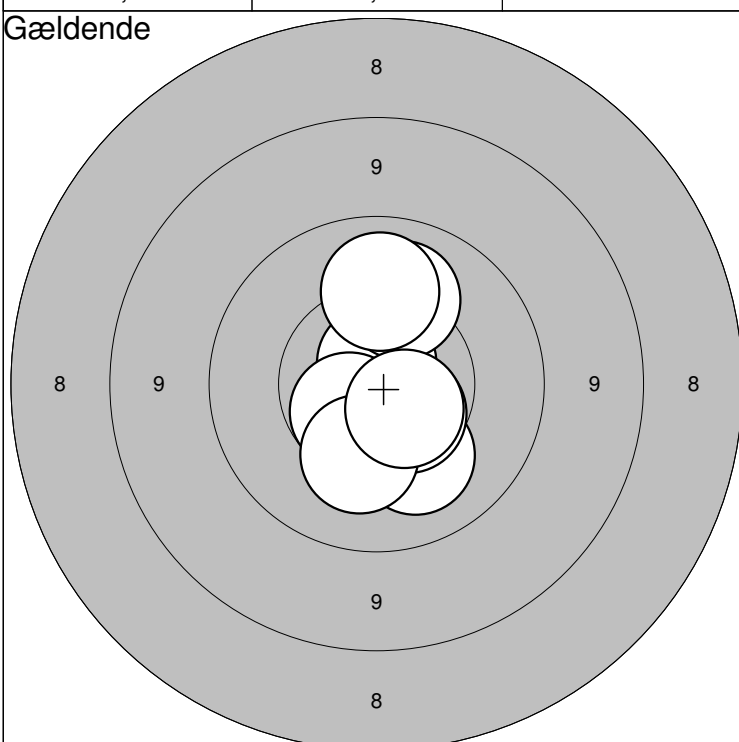

Gældende

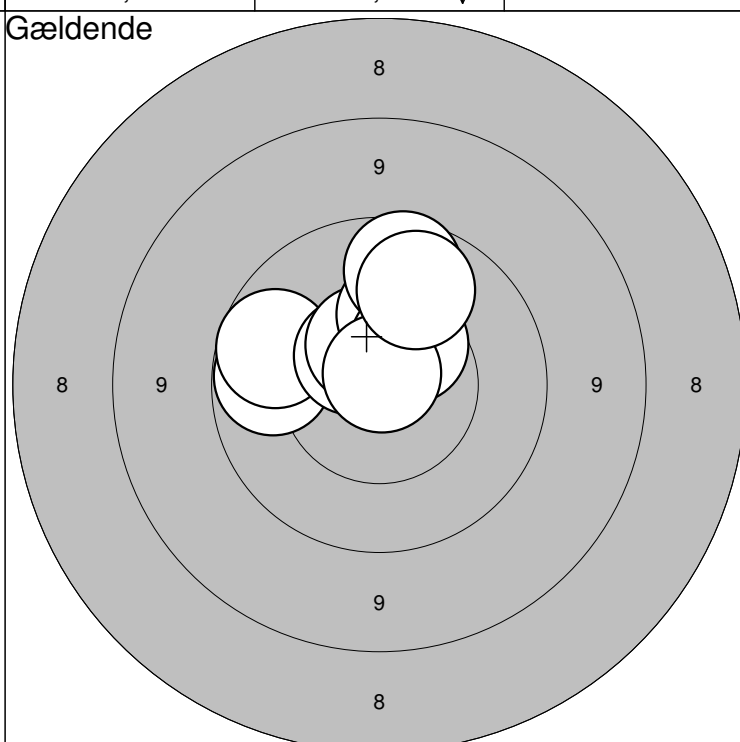

1: 10,2 ↓

2: 10,6 ↓

3: 10,8* ↘

4: 10,8* ↓

5: 10,8* ↑

6: 10,6* ↘

7: 10,1 ↑

8: 10,1 ↑

9: 10,3 ↓

10: 10,6* ↘

Serie: 100,0

Sum: 100,0

11: 10,0 ←

12: 9,9 ←

13: 10,6 ↑

14: 10,6* ↗

15: 10,6 ↗

16: 10,3 ↑

17: 9,9 ↑

18: 10,5 ↗

19: 10,8* ↑

20: 10,0 ↑

Serie: 98,0

Sum: 198,0

Jyllandsstævne 2011

Hold

63

Bane

10

Jeppe V. Kristensen

Aalborg Skyttekreds

1

Jyllandsstævne 2011 - riffel

Aalborg Skyttekreds

Prøveskud

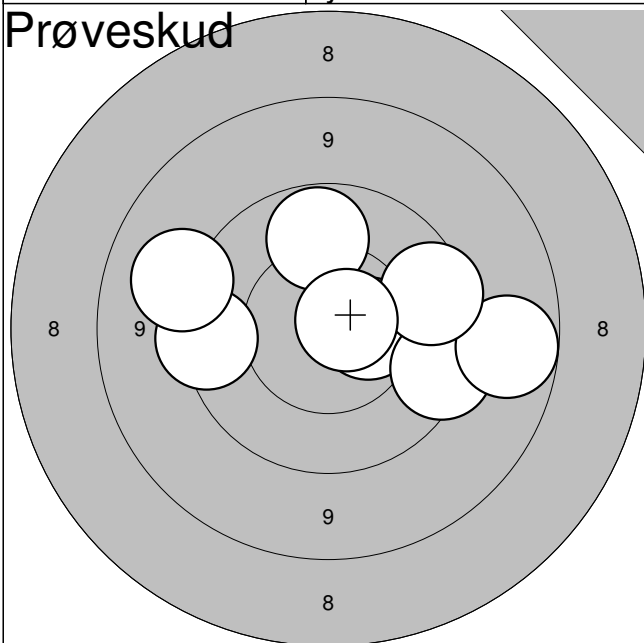

1:	10,5	→
2:	9,6	→
3:	9,0	→
4:	9,6	←
5:	10,0	↑
6:	9,3	←
7:	9,8	→
8:	10,7*	→

Serie: 75,0

Sum: 0,0

Gældende

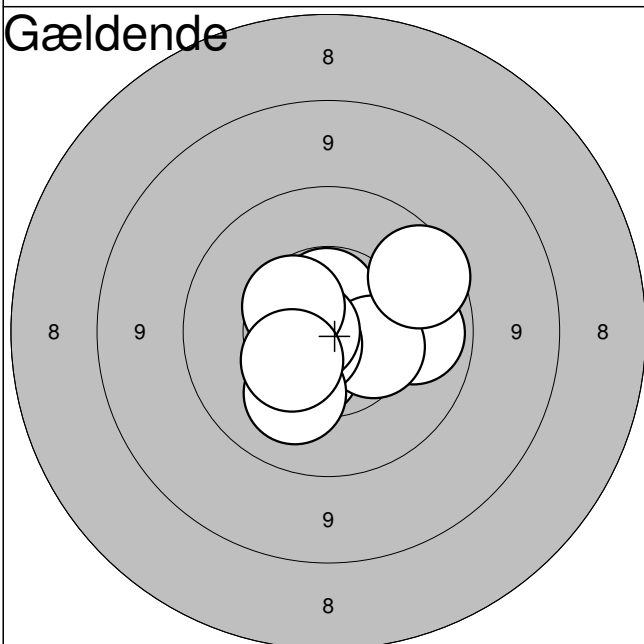

1:	10,5	↙
2:	10,0	→
3:	10,6*	↑
4:	10,4	→
5:	10,7*	↙
6:	10,7*	←
7:	10,2	↙
8:	9,8	↗
9:	10,5	↗
10:	10,5	↙

Serie: 99,0

Sum: 99,0

Gældende

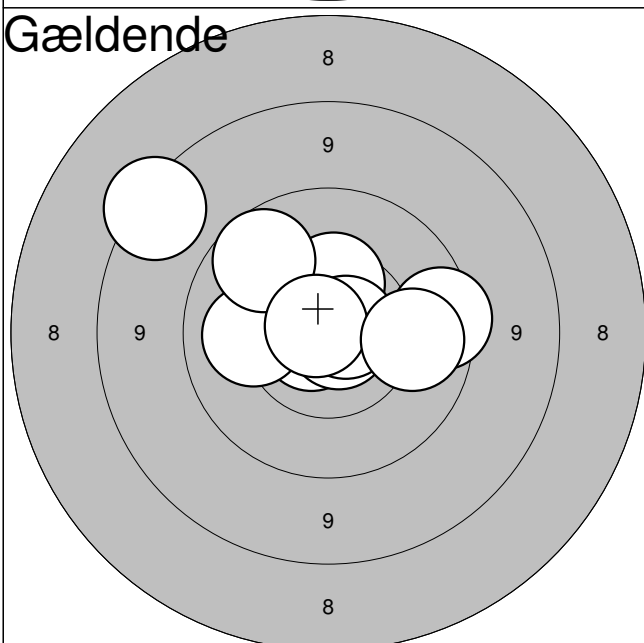

11:	9,7	→
12:	10,8*	←
13:	10,8*	→
14:	10,4	↑
15:	10,2	←
16:	9,9	↗
17:	8,6	↗
18:	10,8*	→
19:	10,8*	↖
20:	10,0	→

Serie: 96,0

Sum: 195,0

Jyllandsstævne 2011

Hold

63

Bane

11

Daniel Mørk

Hobro Egnens Skytteforening

BK2

Jyllandsstævne 2011 - riffel

Aalborg Skyttekreds

Prøveskud

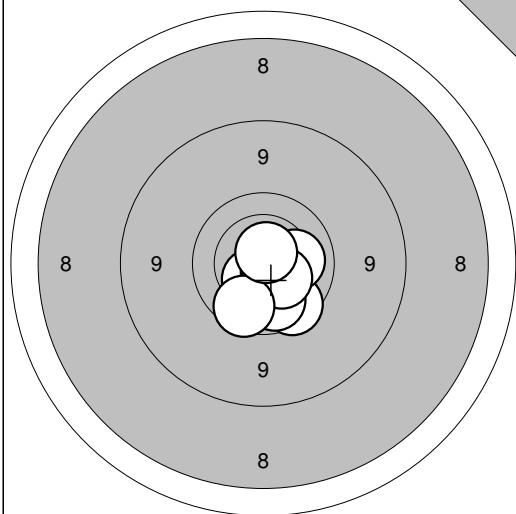

1: 9,8 ↘
 2: 10,5 ↘
 3: 10,5 ↘
 4: 10,0 ↘
 5: 10,2 →
 6: 10,7* ↘
 7: 10,7* ↘
 8: 10,4 ↘
 9: 9,9 ↘
 10: 10,7* ↗

Serie: 98,0

Sum: 0,0

Prøveskud

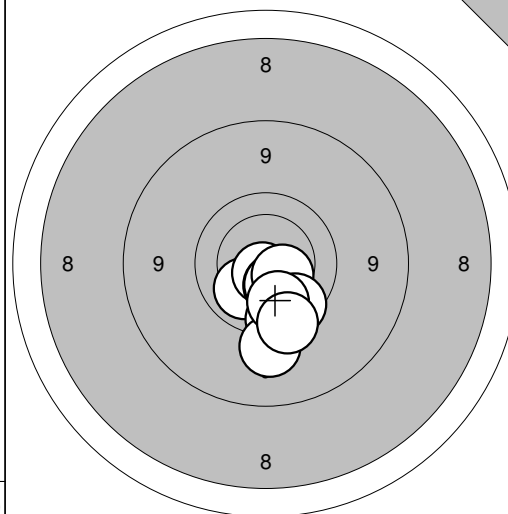

11: 10,1 ↘
 12: 10,7* ↘
 13: 10,4 ↘
 14: 10,4 ↘
 15: 9,7 ↘
 16: 10,4 ↘
 17: 9,8 ↘
 18: 9,4 ↘
 19: 9,9 ↘
 20: 9,6 ↘

Serie: 95,0

Sum: 0,0

Prøveskud

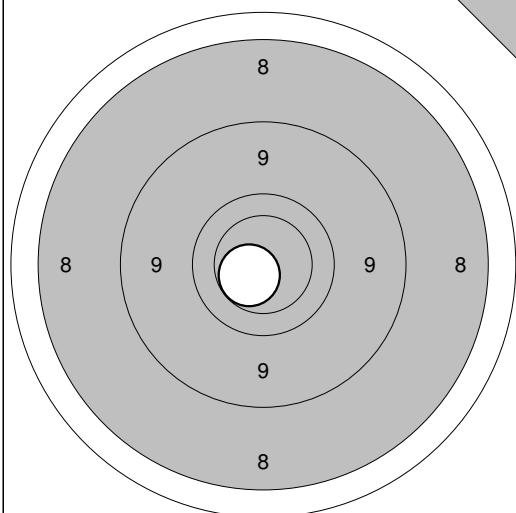

21: 10,5* ↙

Serie: 10,0

Sum: 0,0

Gældende

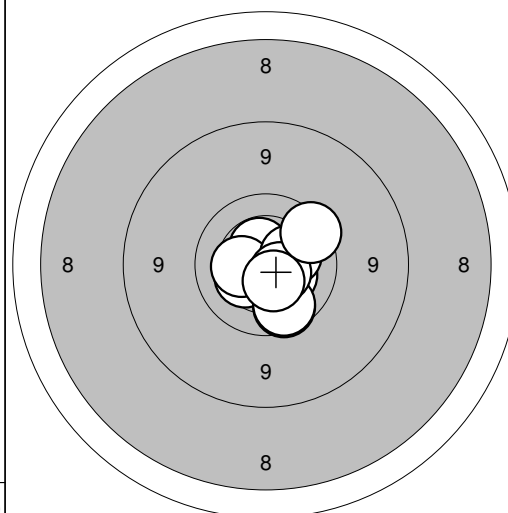

1: 10,5* ↗
 2: 10,4 ↙
 3: 9,9 ↘
 4: 10,4 →
 5: 10,4 ←
 6: 9,9 ↘
 7: 10,3 →
 8: 10,5* ↘
 9: 10,5* ↘
 10: 9,7 ↗

Serie: 97,0

Sum: 97,0

Gældende

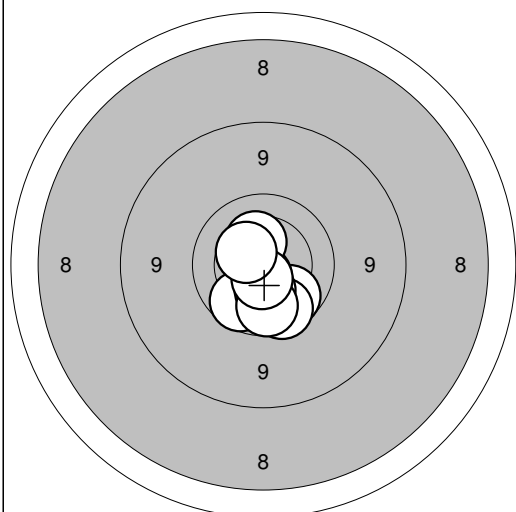

11: 9,9 ↘
 12: 10,7* ↘
 13: 10,4 ↗
 14: 9,9 ↘
 15: 10,1 ↘
 16: 9,9 ↘
 17: 10,3 ↘
 18: 9,9 ↘
 19: 10,6* ↘
 20: 10,4 ↗

Serie: 96,0

Sum: 193,0

Jyllandsstævne 2011

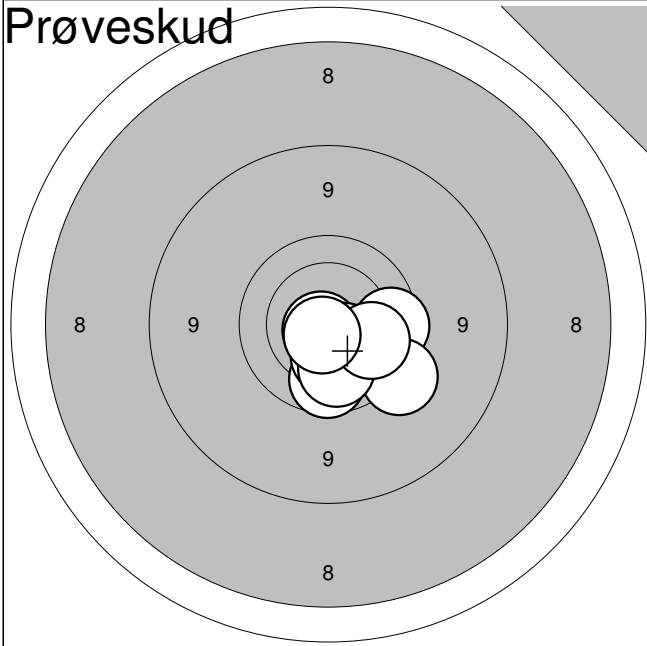

1:	9,9	↓
2:	9,8	→
3:	9,5	↓
4:	10,8*	↙
5:	10,5*	↘
6:	10,3	↓
7:	10,3	↓
8:	10,1	↓
9:	10,0	→
10:	10,7*	↘

Serie:	97,0
Sum:	0,0

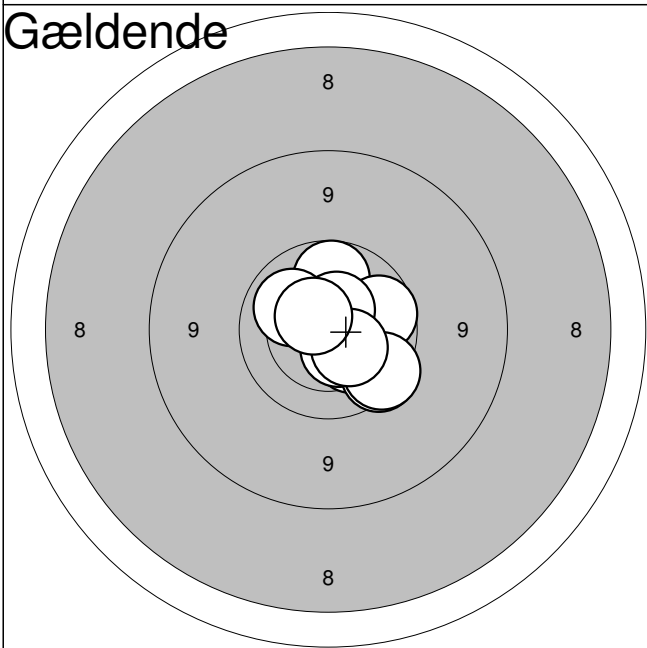

1:	10,0	↑
2:	10,3	↘
3:	10,1	↗
4:	9,9	→
5:	10,5*	↗
6:	10,5*	↘
7:	9,8	↘
8:	9,8	↘
9:	10,4	↘
10:	10,6*	↗

Serie:	97,0
Sum:	97,0

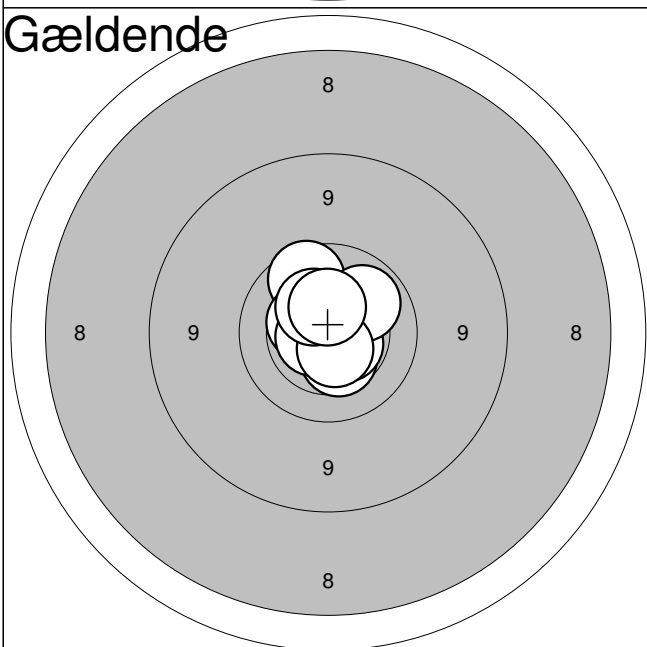

11:	10,4	↘
12:	9,9	↗
13:	10,5	↗
14:	10,8*	↗
15:	10,6*	↘
16:	10,1	↗
17:	10,7*	↙
18:	10,6*	↘
19:	10,4	↗
20:	10,4	↑

Serie:	99,0
Sum:	196,0

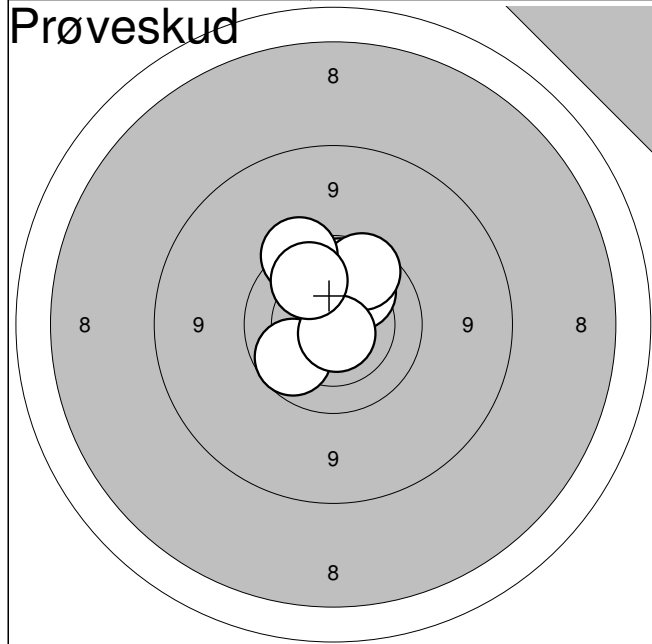

1:	9,9	↙
2:	10,2	↗
3:	10,0	↑
4:	9,8	↗
5:	9,7	↗
6:	10,8*	↘
7:	10,0	↗

Serie:	67,0
Sum:	0,0

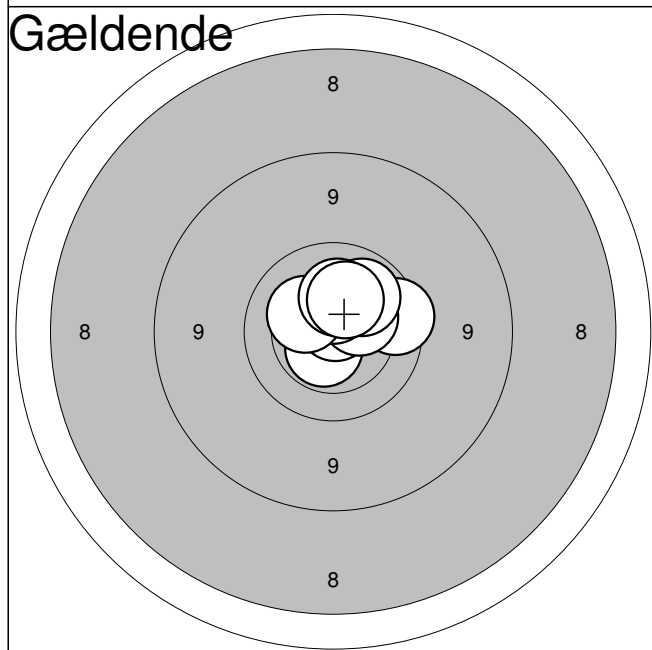

1:	10,6*	↑
2:	10,6*	↘
3:	10,8*	↑
4:	9,8	→
5:	10,4	↗
6:	10,4	↑
7:	10,3	↙
8:	10,1	↗
9:	10,3	↑
10:	10,3	↑

Serie:	99,0
Sum:	99,0

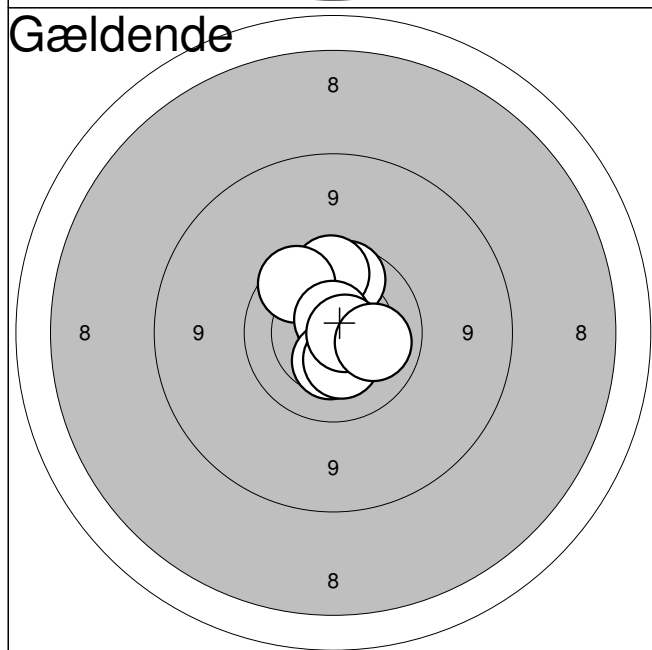

11:	9,9	↑
12:	10,9*	↗
13:	9,9	↑
14:	9,8	↗
15:	10,7*	↑
16:	10,5	→
17:	10,4	↘
18:	10,4	↘
19:	10,7*	→
20:	10,1	→

Serie:	97,0
Sum:	196,0

Hold
64Bane
2**Bodil Abildgaard**

Hobro Egnens Skytteforening

ÅK2

Jyllandsstævne 2011 - riffel

Aalborg Skyttekreds

Prøveskud

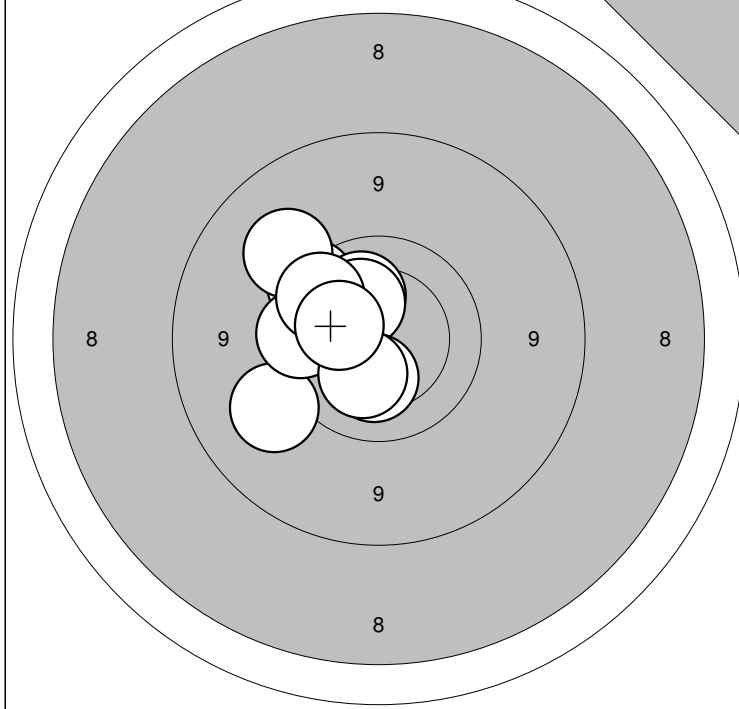

Prøveskud

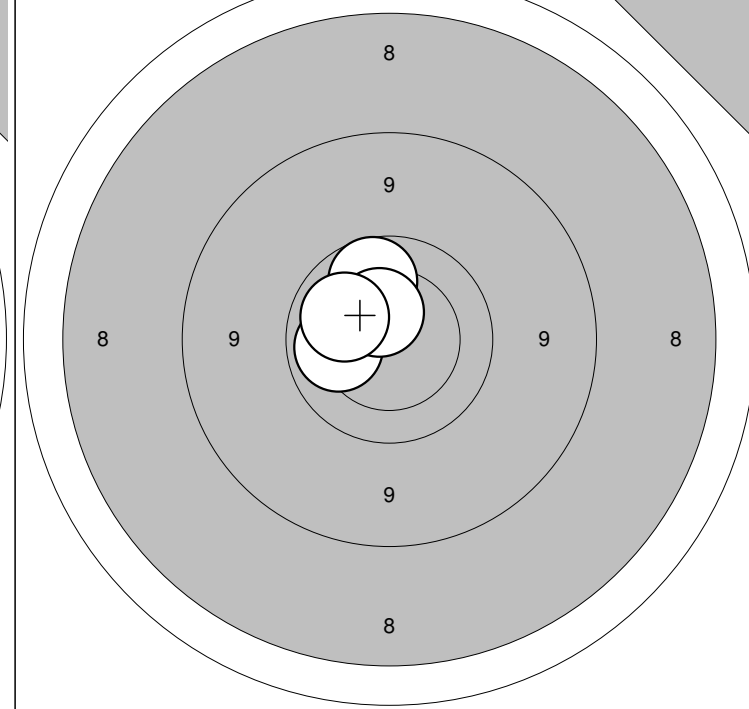

1: 9,3 ↙
2: 9,7 ↗
3: 10,2 ↗
4: 10,3 ↗
5: 9,3 ↗

6: 10,3 ↓
7: 9,8 ←
8: 10,3 ↓
9: 9,8 ↗
10: 10,3 ←

Serie: 95,0
Sum: 0,0

11: 9,9 ↑
12: 10,1 ←
13: 10,5 ↑
14: 10,1 ↙

Serie: 39,0
Sum: 0,0

Gældende

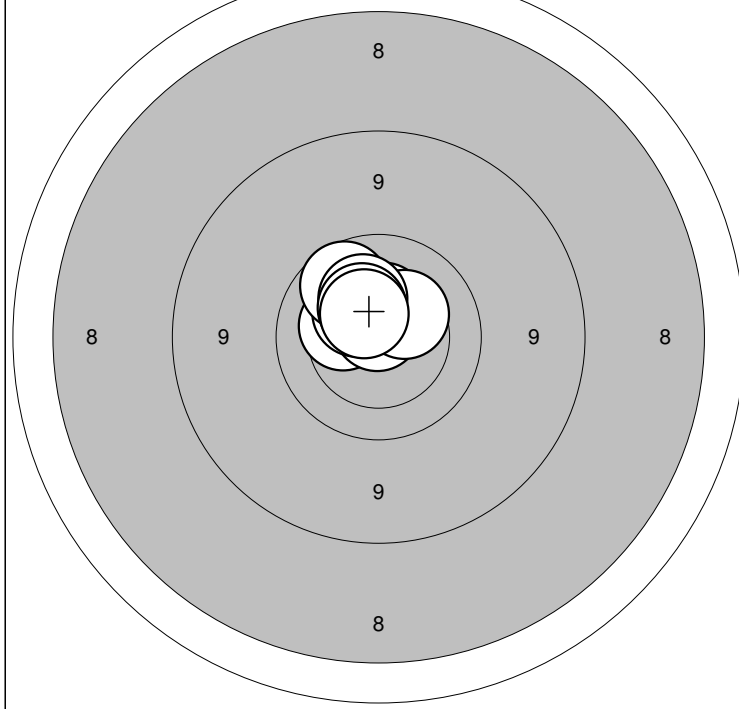

Gældende

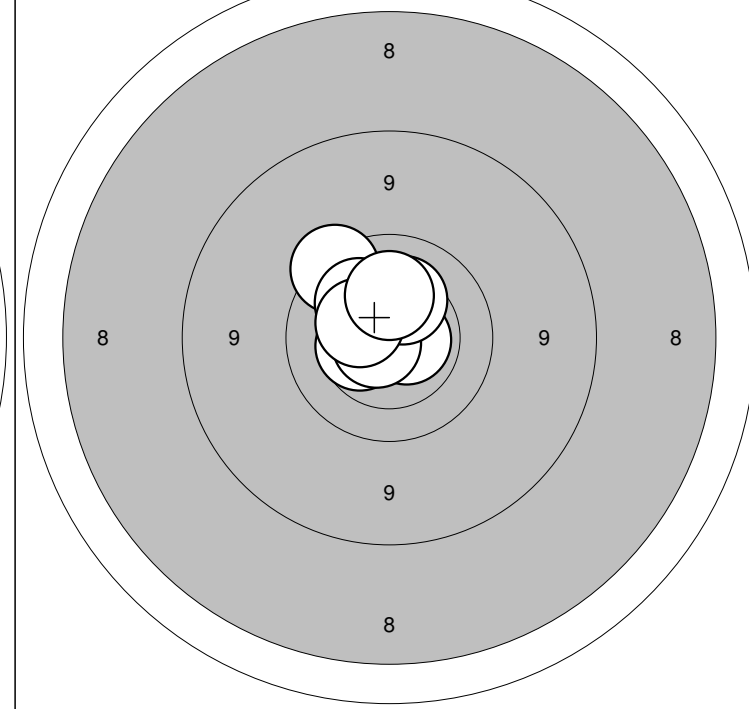

1: 10,3 ↙
2: 10,6* ↑
3: 10,8* ↑
4: 10,4 ↗
5: 10,4 ↑

6: 10,4 ↗
7: 9,9 ↗
8: 10,2 ↗
9: 10,4 ↗
10: 10,5* ↗

Serie: 99,0
Sum: 99,0

11: 10,4 ↗
12: 9,7 ↗
13: 10,7* ←
14: 10,4 ←
15: 10,7* →

16: 10,7* ←
17: 10,2 ↗
18: 10,3 ↑
19: 10,4 ↙
20: 10,2 ↑

Serie: 99,0
Sum: 198,0

Jyllandsstævne 2011

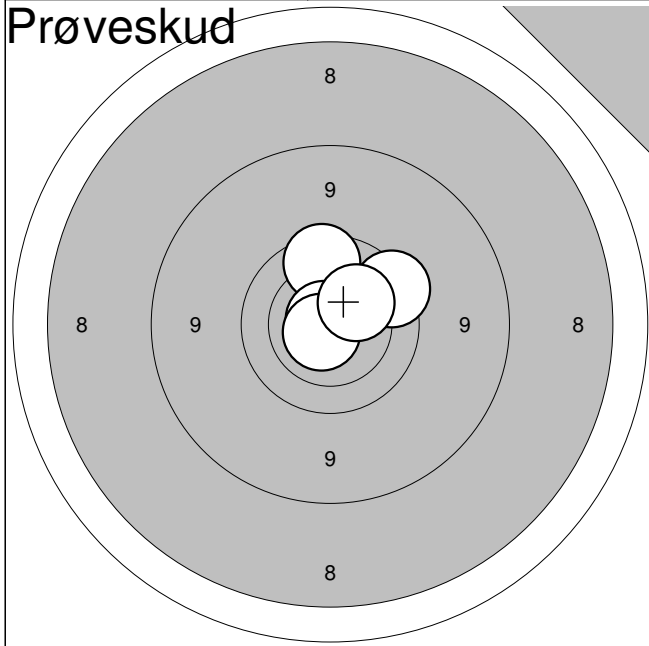

1:	9,7	↗
2:	9,8	↑
3:	10,8*	↖
4:	10,7*	↙
5:	10,3	↗
Serie:	48,0	
Sum:	0,0	

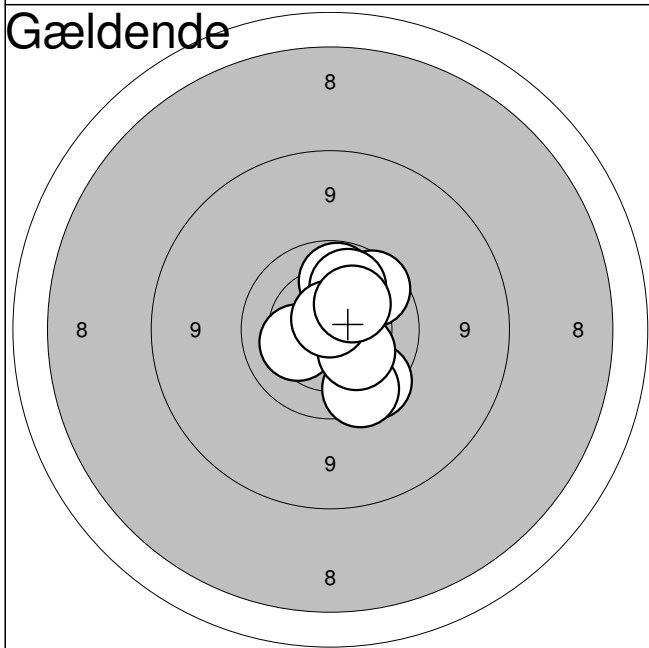

1:	10,3	←
2:	10,1	↗
3:	9,9	↗
4:	9,8	↘
5:	9,8	↘
6:	10,3	↘
7:	10,0	↑
8:	10,1	↑
9:	10,7*	↑
10:	10,3	↗
Serie:	97,0	
Sum:	97,0	

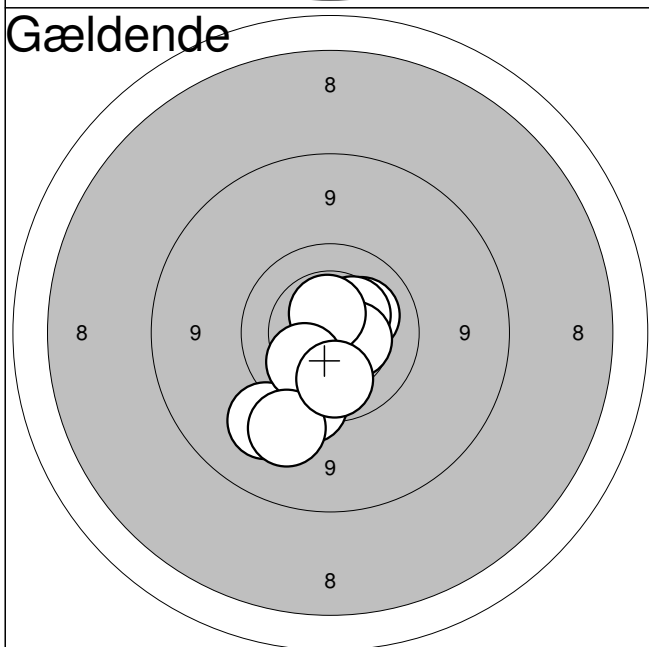

11:	10,3	↗
12:	10,8*	↗
13:	10,4	↗
14:	10,5	→
15:	9,7	↘
16:	9,3	↘
17:	10,6*	↑
18:	10,2	↙
19:	9,4	↙
20:	10,0	↓
Serie:	97,0	
Sum:	194,0	

Hold

64

Bane

4

Søren Otte

Hjørring Skytteforening

J2

Jyllandsstævne 2011 - riffel

Aalborg Skyttekreds

Prøveskud

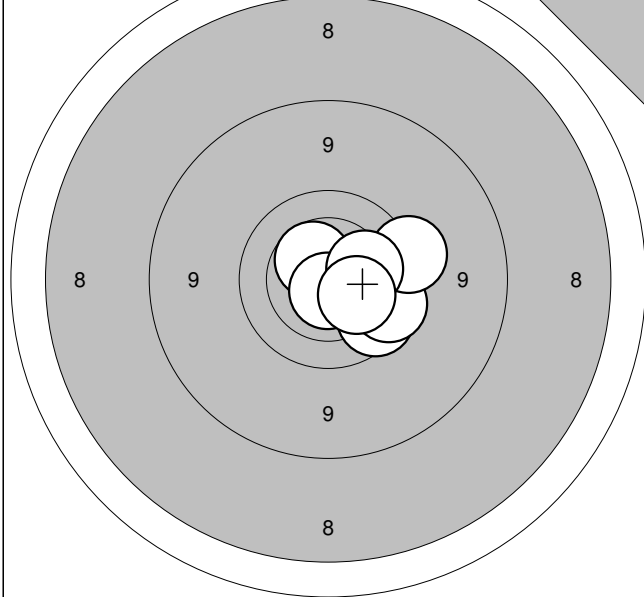

1: 10,5



2: 9,8



3: 9,8



4: 10,7*



5: 9,6



6: 10,2



7: 10,3



Serie:

67,0

Sum:

0,0

Gældende

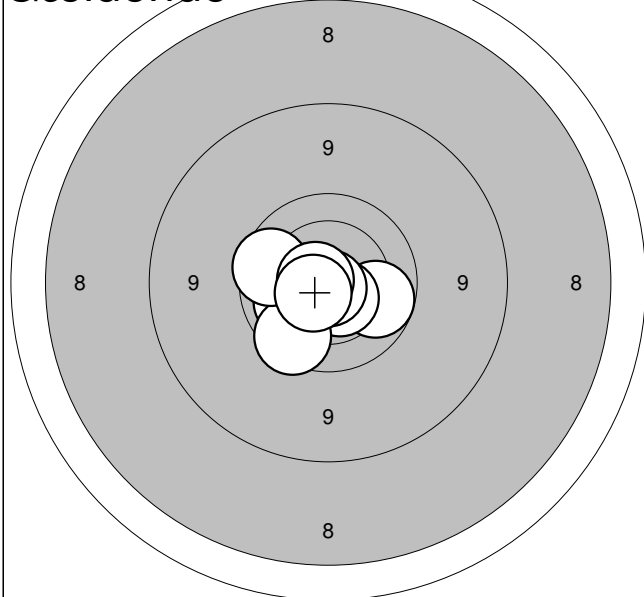

1: 10,0



2: 10,6*



3: 10,5*



4: 10,2



5: 10,6*



6: 10,8*



7: 9,8



8: 9,9



9: 10,7*



10: 10,6*



Serie:

98,0

Sum:

98,0

Gældende

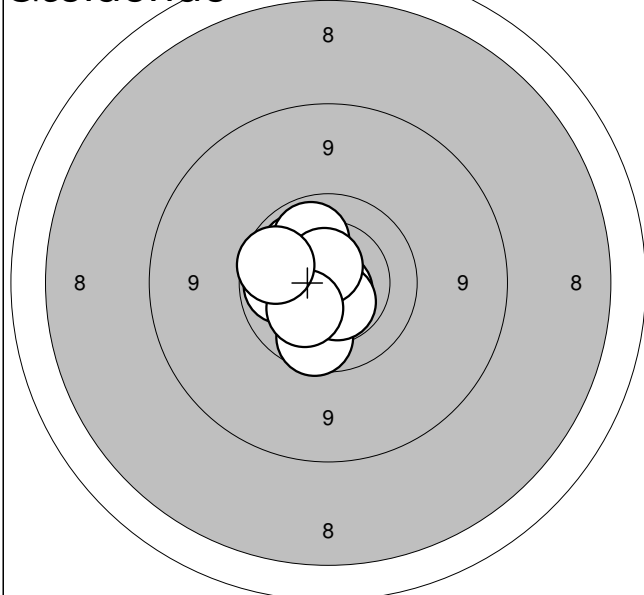

11: 10,7*



12: 9,9



13: 10,1



14: 10,0



15: 10,1



16: 10,5*



17: 10,1



18: 10,6*



19: 10,3



20: 9,9



Serie:

98,0

Sum:

196,0

Jyllandsstævne 2011

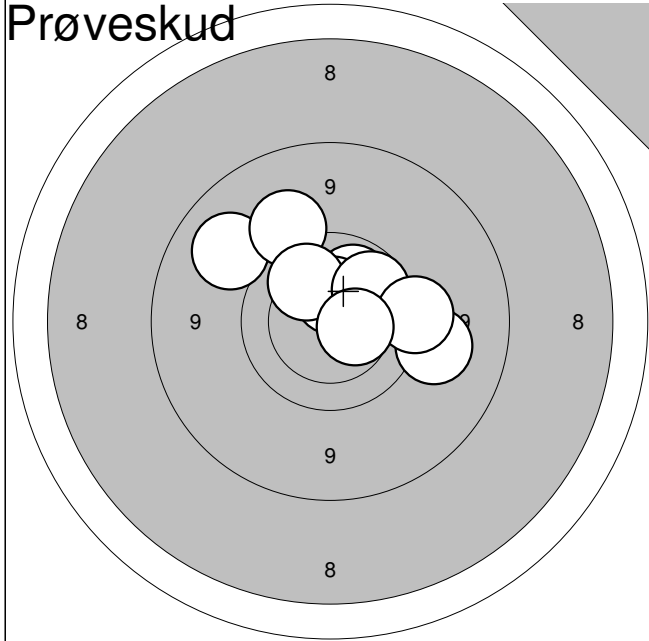

1:	9,2	↖
2:	10,1	↗
3:	9,3	→
4:	10,4	↑
5:	9,4	↗
6:	10,1	↗
7:	9,9	↗
8:	9,6	→
9:	10,4	→

Serie: 85,0

Sum: 0,0

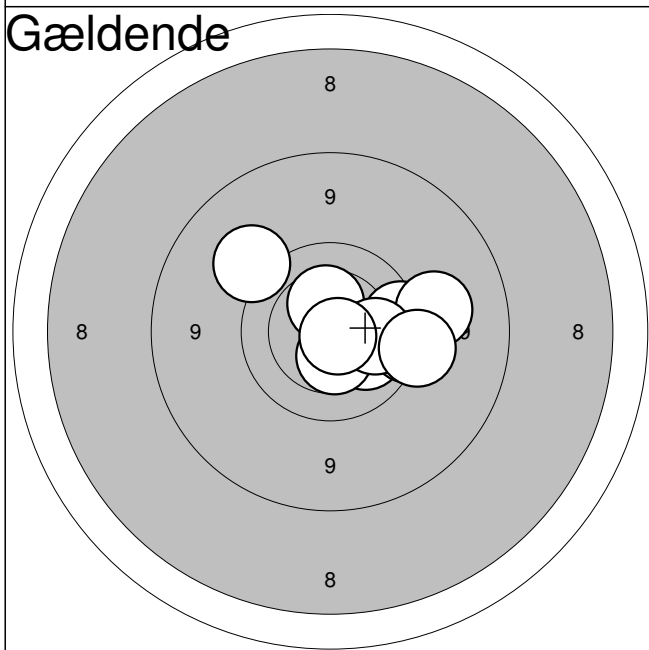

1:	10,4	↑
2:	10,1	↘
3:	9,6	→
4:	9,7	→
5:	10,5	↘
6:	9,3	→
7:	10,1	→
8:	9,4	↗
9:	10,8*	↘
10:	9,5	→

Serie: 95,0

Sum: 95,0

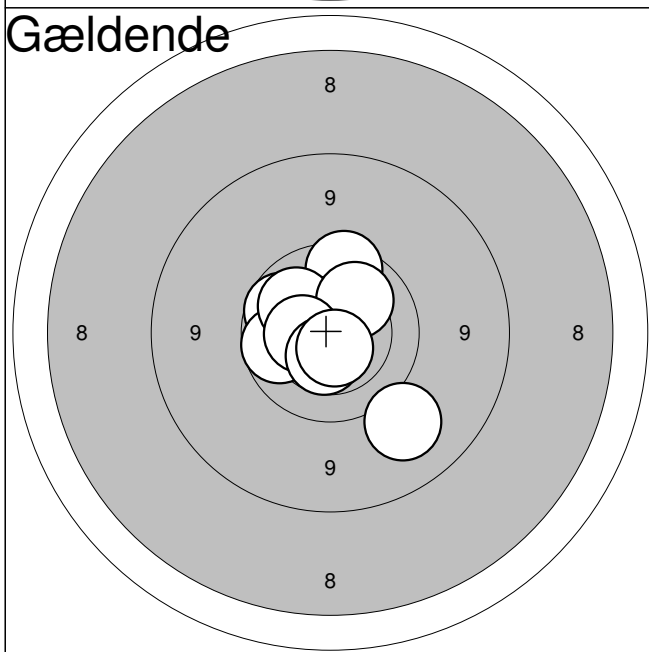

11:	9,9	↖
12:	9,8	↑
13:	9,9	↖
14:	10,6*	↑
15:	10,1	↗
16:	9,2	↘
17:	10,2	↗
18:	10,4	↖
19:	10,5	↘
20:	10,6*	↘

Serie: 96,0

Sum: 191,0

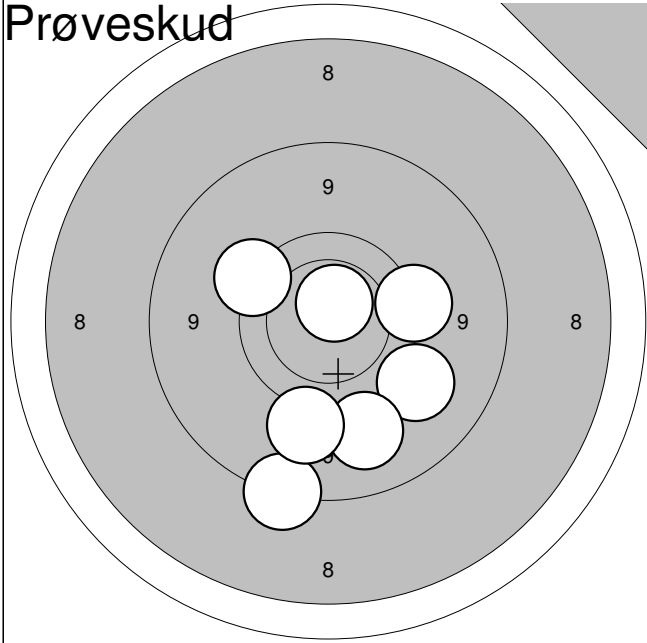

1:	9,5	→
2:	10,6*	↑
3:	9,3	↘
4:	9,2	↘
5:	8,7	↘
6:	9,3	↘
7:	9,5	↗

Serie:	63,0
Sum:	0,0

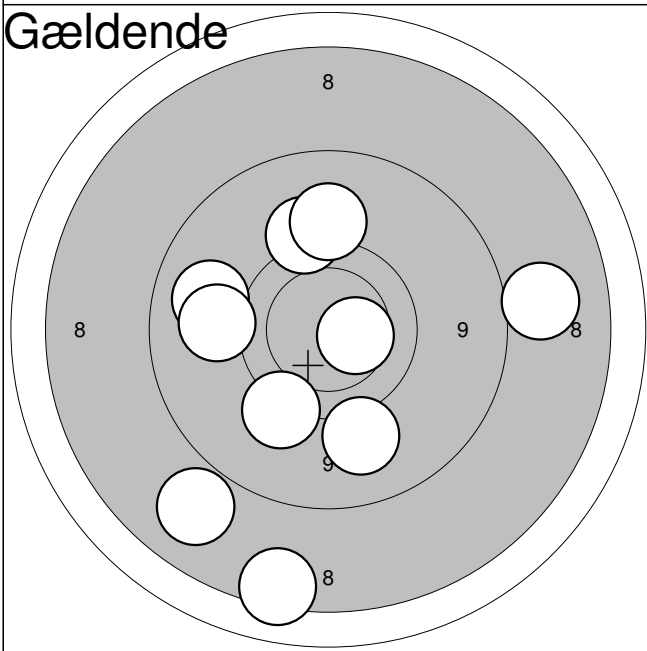

1:	10,4	→
2:	9,4	↑
3:	9,2	←
4:	9,3	←
5:	9,3	↑
6:	8,4	↘
7:	8,4	→
8:	9,5	↘
9:	9,3	↘
10:	8,1	↘

Serie:	88,0
Sum:	88,0

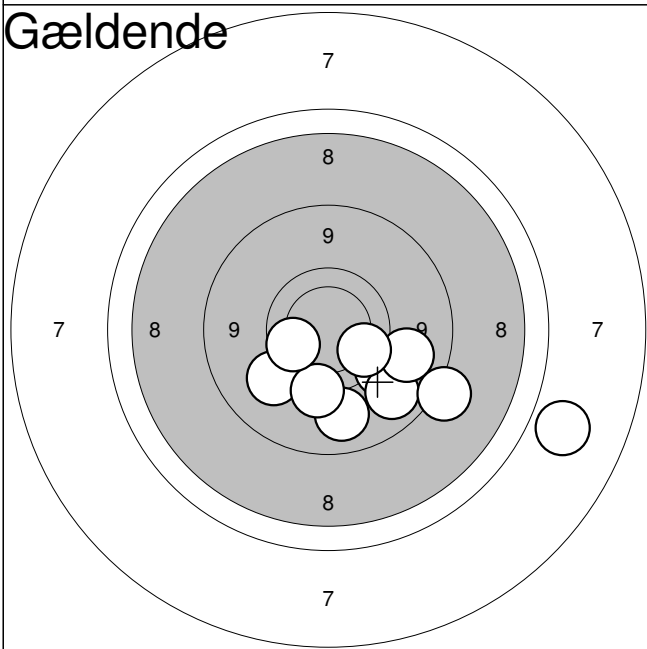

11:	9,1	↘
12:	9,4	↘
13:	7,3	→
14:	9,4	↘
15:	9,5	↘
16:	9,1	↘
17:	9,2	→
18:	9,9	←
19:	9,9	↘
20:	8,6	↘

Serie:	87,0
Sum:	175,0

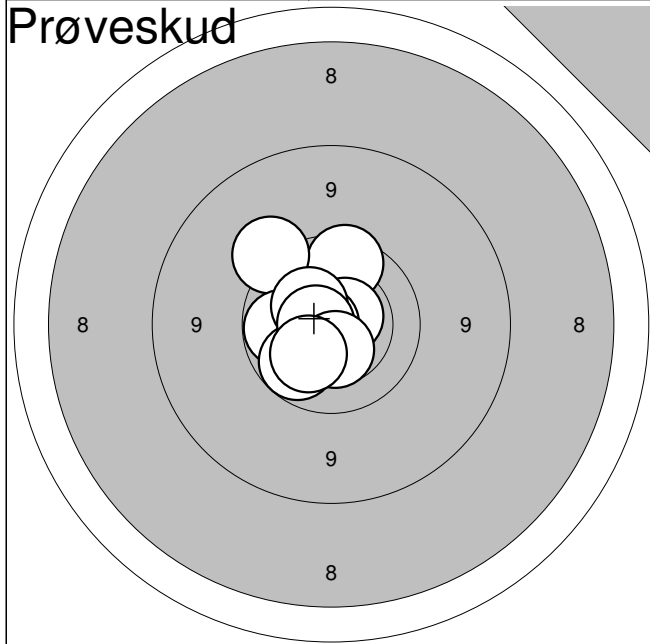

1:	9,8	↑
2:	9,5	↗
3:	10,0	←
4:	10,6*	↗
5:	10,8*	←
6:	10,0	↘
7:	10,4	↗
8:	10,7*	←
9:	10,5	↓
10:	10,2	↘

Serie: 98,0

Sum: 0,0

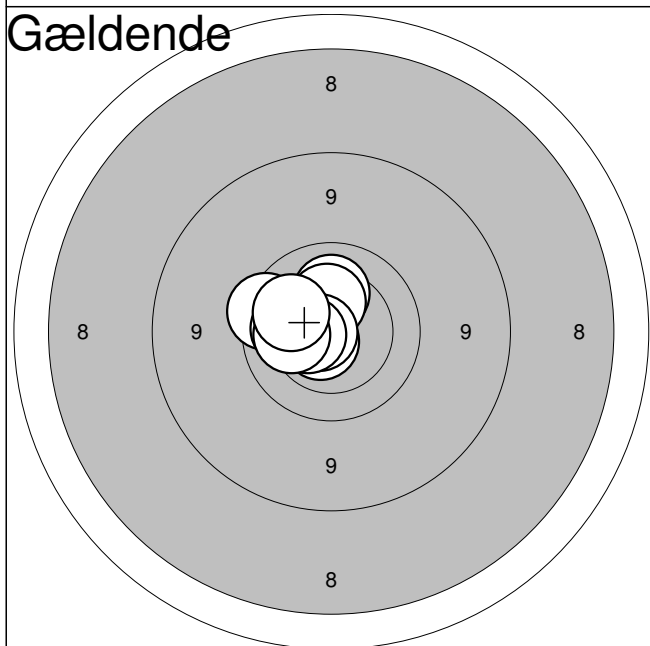

1:	10,2	↑
2:	10,1	←
3:	9,8	←
4:	10,4	↑
5:	10,7*	↘
6:	10,7*	←
7:	10,5*	←
8:	10,1	←
9:	10,2	←
10:	10,1	↖

Serie: 99,0

Sum: 99,0

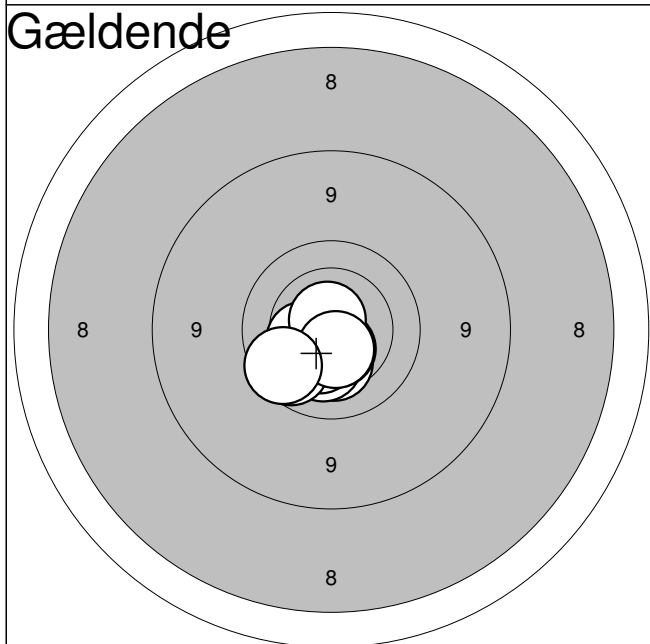

11:	10,1	↘
12:	10,4	←
13:	10,3	↓
14:	10,3	↓
15:	10,4	↘
16:	10,6*	↘
17:	9,9	↖
18:	10,8*	↗
19:	10,5*	↓
20:	9,9	↘

Serie: 98,0

Sum: 197,0

Hold
64Bane
8**Ida V. Stenholt**

Hobro Egnens Skytteforening

BK2

Jyllandsstævne 2011 - riffel

Aalborg Skyttekreds

Prøveskud

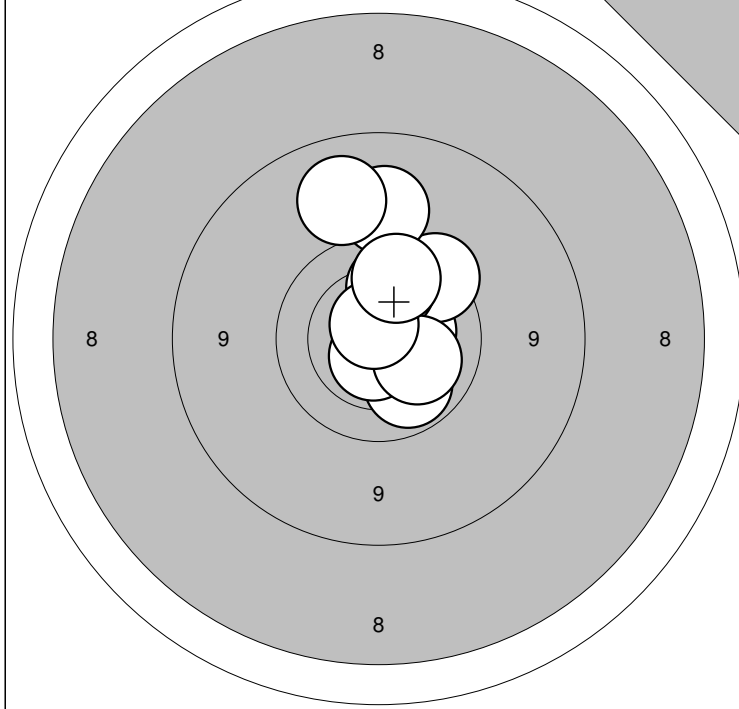

Prøveskud

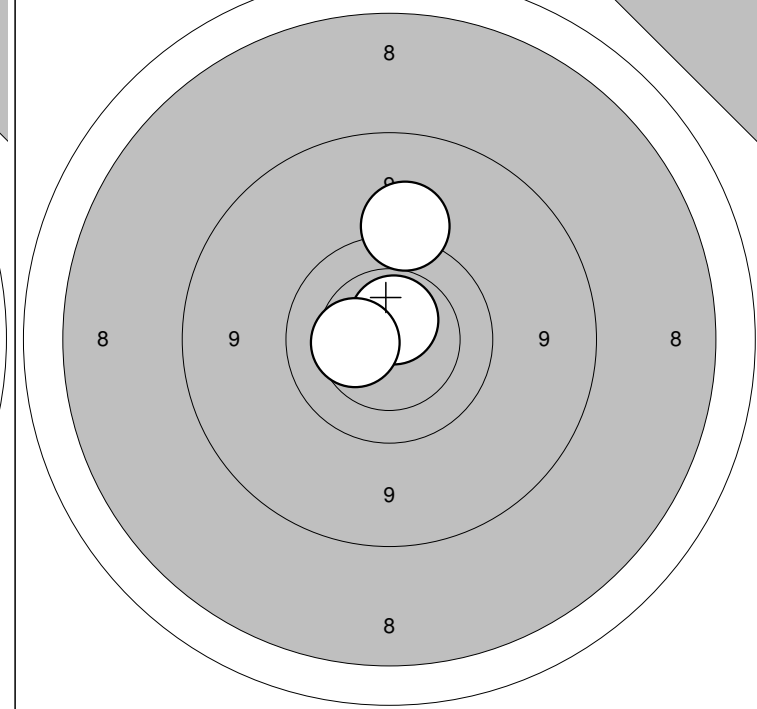

1:10,0 ↘
2:10,4 →
3: 9,7 ↗
4:10,6* ↓
5: 9,3 ↑

6:10,1 ↑
7:10,2 ↘
8: 9,1 ↑
9:10,7* ↑
10: 9,9 ↑

Serie: 96,0

Sum: 0,0

11: 9,4 ↑
12:10,6* ↑
13:10,4 ←

Serie: 29,0

Sum: 0,0

Gældende

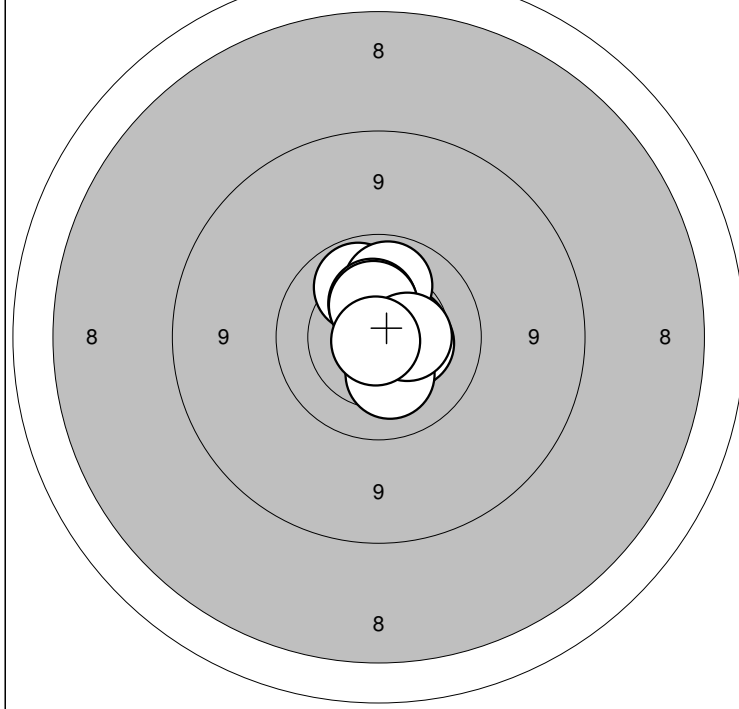

Gældende

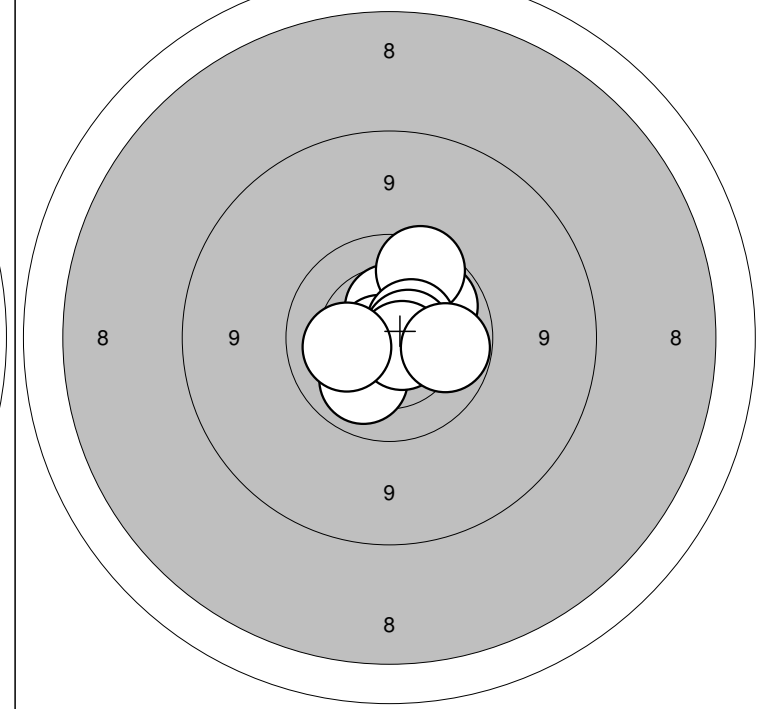

1:10,0 ↑
2:10,5* →
3:10,4 →
4:10,1 ↑
5:10,5 ↓

6:10,4 ↑
7:10,3 ↓
8:10,4 ↑
9:10,5 →
10:10,9* ↘

Serie: 100,0

Sum: 100,0

11:10,5 ↑
12:10,0 ↗
13: 9,8 ↑
14:10,8* ←
15:10,1 ↓

16:10,5* ↗
17:10,6* →
18:10,7* ↘
19:10,0 →
20:10,2 ←

Serie: 99,0

Sum: 199,0

Jyllandsstævne 2011

Hold

64

Bane

9

Frede Kristensen

Aalborg Skyttekreds

ÅK1

Jyllandsstævne 2011 - riffel

Aalborg Skyttekreds

Prøveskud

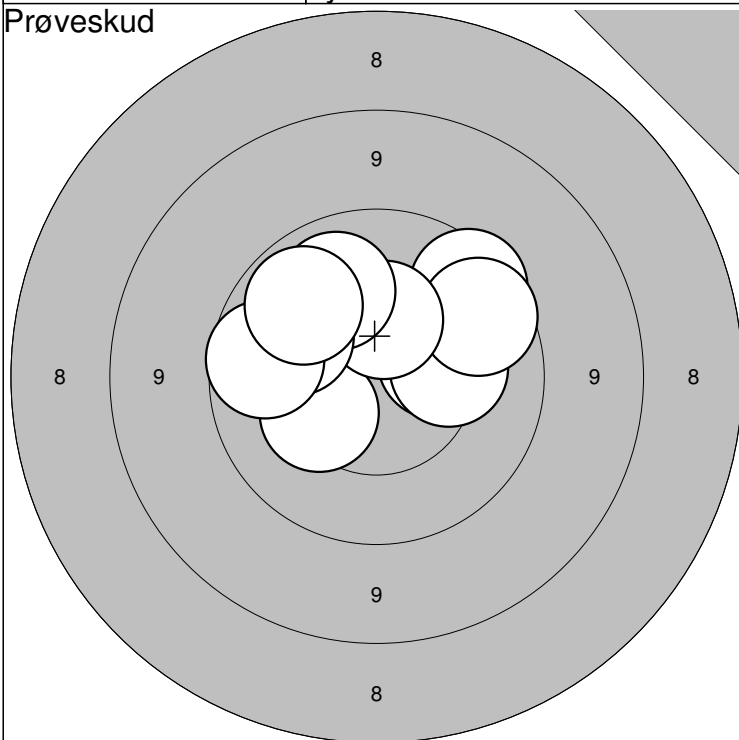

Prøveskud

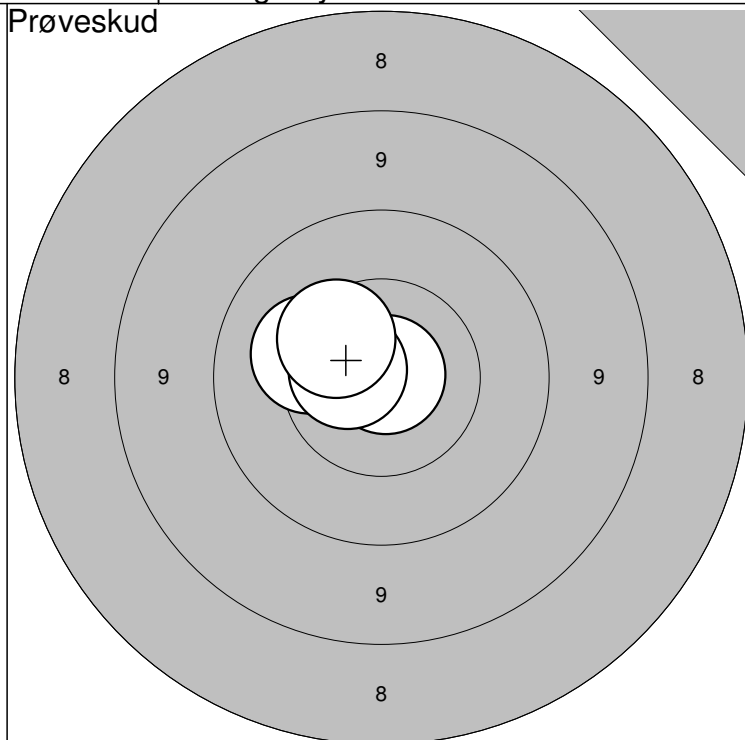

1:10,4



6:10,4



Serie:

97,0

2:10,3



7:10,1



11:10,3



Serie:

40,0

3: 9,8



8:10,1



12:10,9*



4:10,3



9: 9,9



13:10,6*



5: 9,9



10:10,0



Sum:

0,0

14:10,4



Sum:

0,0

Gældende

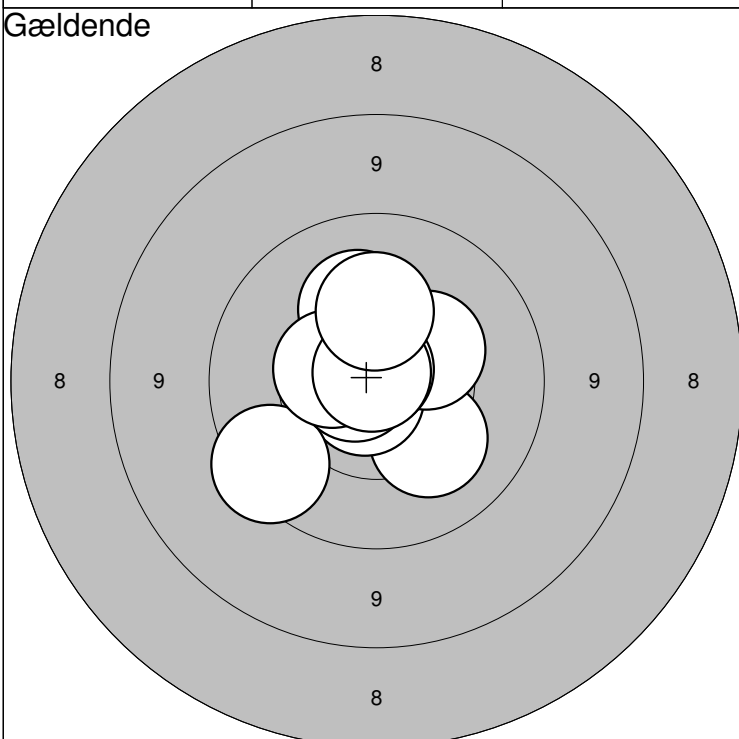

Gældende

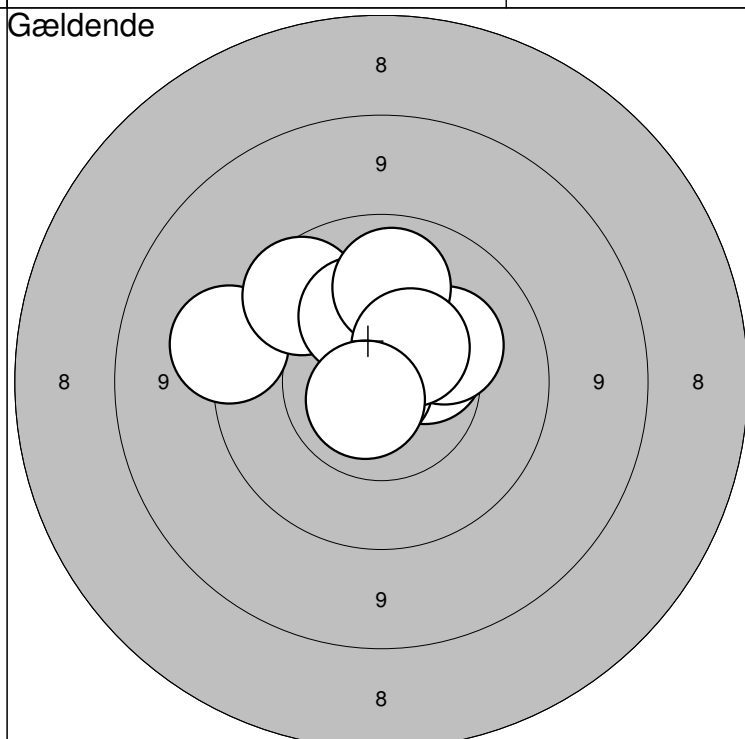

1:10,2



6:10,8*



Serie:

99,0

2:10,8*



7:10,5



11: 9,5



16:10,3



Serie:

98,0

3:10,3



8:10,8*



12: 9,9



17:10,3



4:10,4



9:10,9*



Sum:

99,0

13:10,5



18:10,1



5: 9,7



10:10,3



14:10,9*



19:10,5



Sum:

197,0

15:10,4



20:10,7*



Jyllandsstævne 2011

Hold

64

Bane

10

Benjamin Schou Thomsen

Hobro Egnens Skytteforening

J2

Jyllandsstævne 2011 - riffel

Aalborg Skyttekreds

Prøveskud

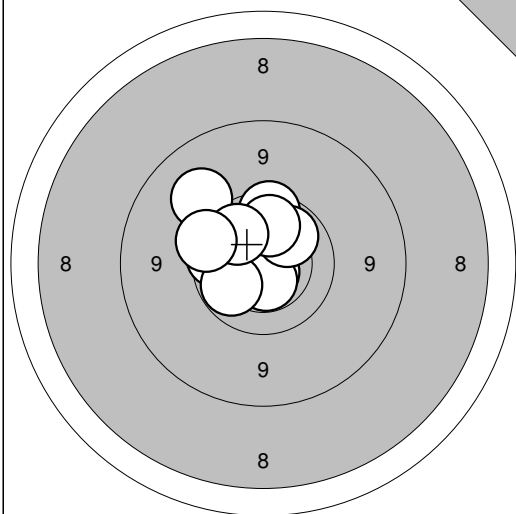

1: 9,8 ↑
 2: 10,7* ↓
 3: 9,3 ↗
 4: 9,9 ←
 5: 10,5* ↓
 6: 10,0 ←
 7: 10,1 ↗
 8: 10,0 ↑
 9: 10,0 ↗
 10: 9,7 ←

Serie: 96,0

Sum: 0,0

Prøveskud

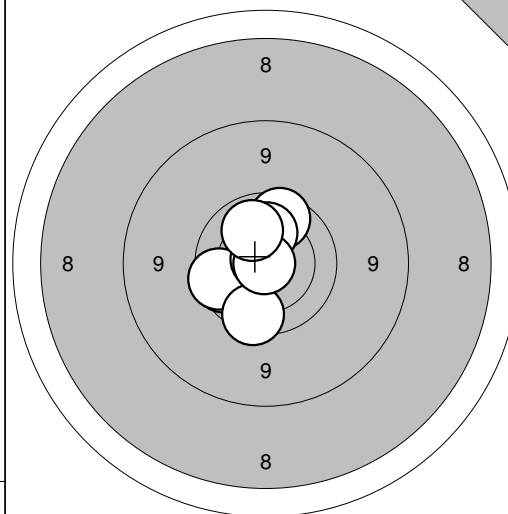

11: 9,9 ←
 12: 10,4 ↗
 13: 10,3 ↑
 14: 9,8 ←
 15: 10,8* ↗
 16: 9,8 ↓
 17: 9,9 ↑
 18: 10,2 ↑
 19: 10,9* ←
 20: 10,1 ↗

Serie: 96,0

Sum: 0,0

Prøveskud

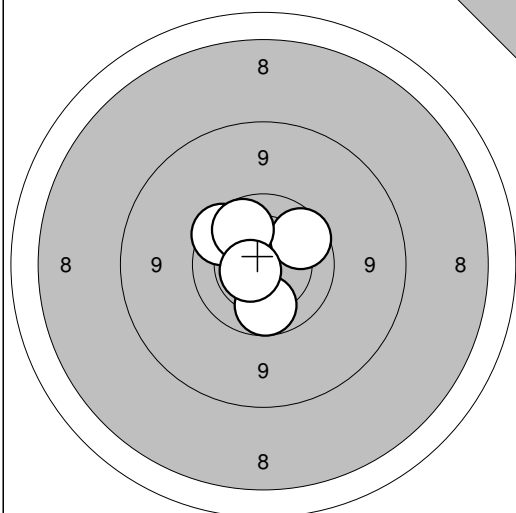

21: 9,8 ↗
 22: 9,9 ↓
 23: 9,9 ↗
 24: 10,0 ↗
 25: 10,6* ←

Serie: 47,0

Sum: 0,0

Gældende

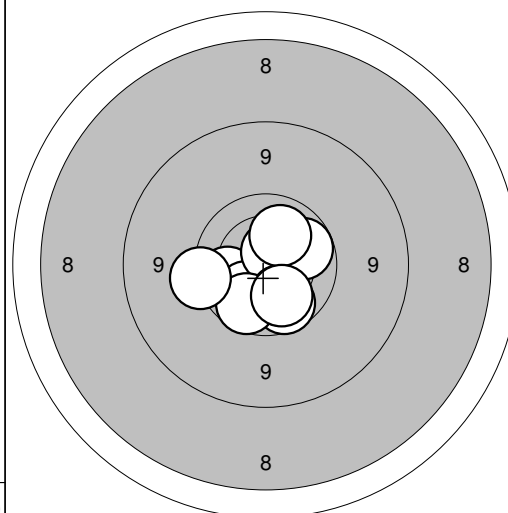

1: 9,9 ↓
 2: 10,0 ←
 3: 10,1 ↘
 4: 10,6* ↗
 5: 10,0 →
 6: 10,1 ↓
 7: 9,9 ↓
 8: 10,2 ↑
 9: 9,6 ←
 10: 10,1 ↓

Serie: 97,0

Sum: 97,0

Gældende

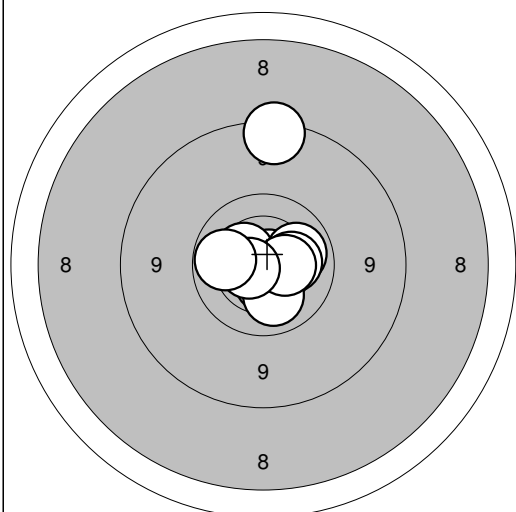

11: 10,8* ↗
 12: 10,4 ↗
 13: 10,1 →
 14: 10,5* ↓
 15: 10,2 →
 16: 10,2 ↓
 17: 10,4 →
 18: 10,6* ←
 19: 10,0 ←
 20: 8,8 ↑

Serie: 98,0

Sum: 195,0

Jyllandsstævne 2011

Hold

64

Bane

11

Daniel Mørk

Hobro Egnens Skytteforening

BK2

Jyllandsstævne 2011 - riffel

Aalborg Skyttekreds

Prøveskud

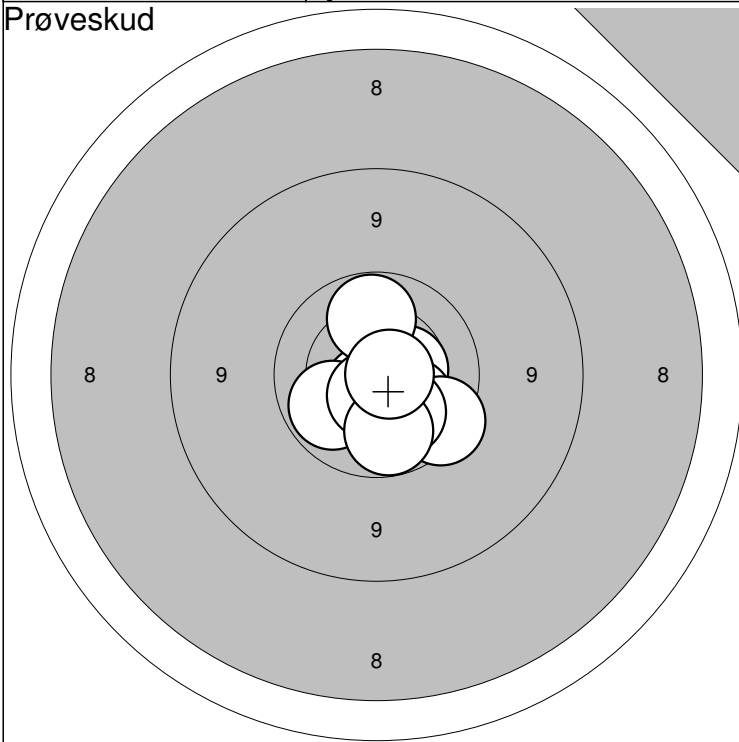

Prøveskud

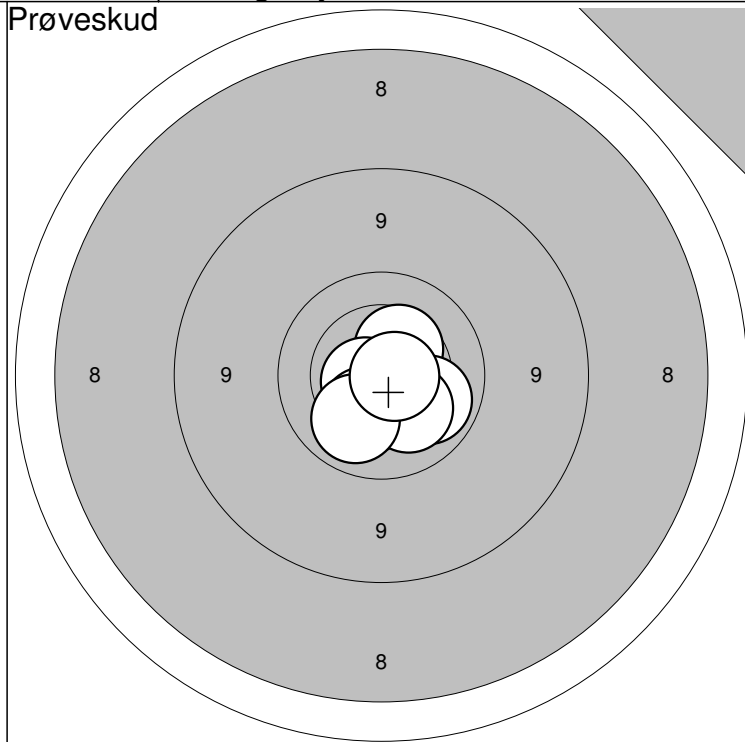

1:10,5 →



6:10,6* ↓



Serie:

99,0

2:10,7* ↓



7:10,2 ↓



3:10,2 ↓



8:10,0 ↓



Sum:

0,0

4: 9,8 ↓



9:10,0 ↑



5:10,0 ↙



10:10,7* →



11:10,6* ↓



12:10,4 ↗



13:10,7* ←



14:10,1 ↘



15:10,3 ↓



16:10,2 ↓



17:10,1 ↓



18:10,7* →



Serie:

80,0

Sum:

0,0

Gældende

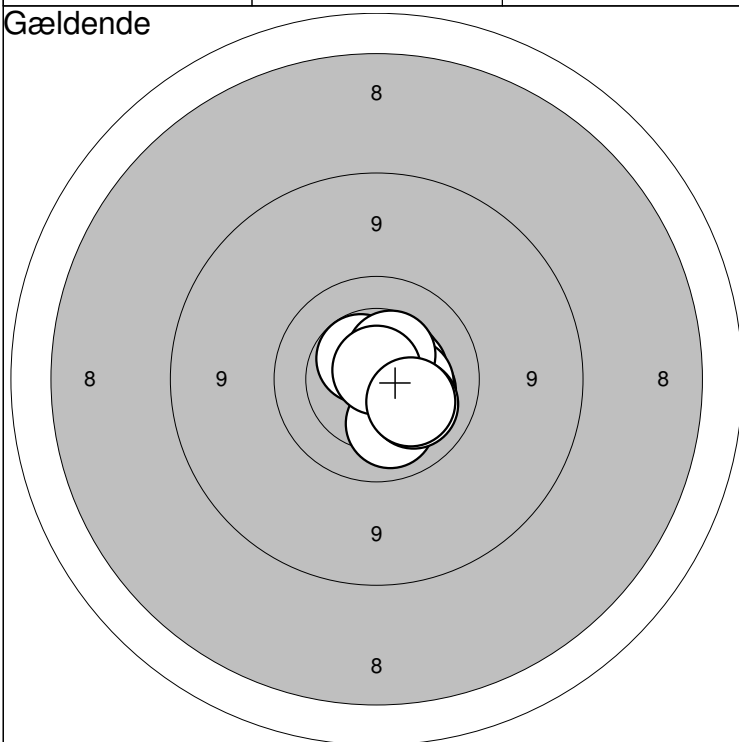

Gældende

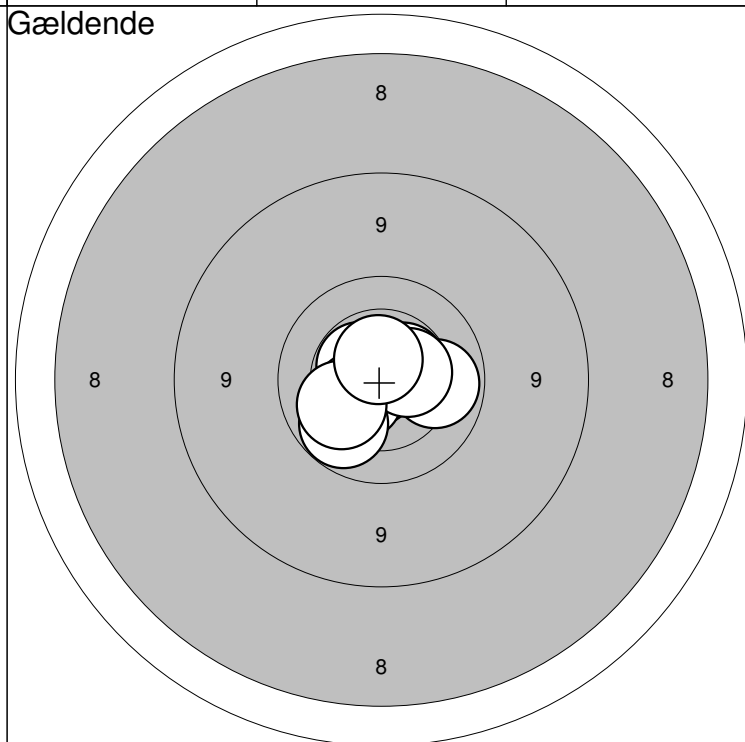

1:10,8* ↗



6:10,5 ↗



Serie:

100,0

2:10,5 →



7:10,2 ↓



3:10,3 ↘



8:10,2 ↓



Sum:

100,0

4:10,4 →



9:10,8* ↑



5:10,5* ↗



10:10,2 ↓



11:10,0 →



12:10,5* ↗



13:10,8* ↑



14:10,5* ↖



15:10,8* ←



16:10,5 ↖



17:10,5 →



18:10,0 ↓



19:10,2 ↖



20:10,6* ↑



Serie:

100,0

Sum:

200,0

Jyllandsstævne 2011

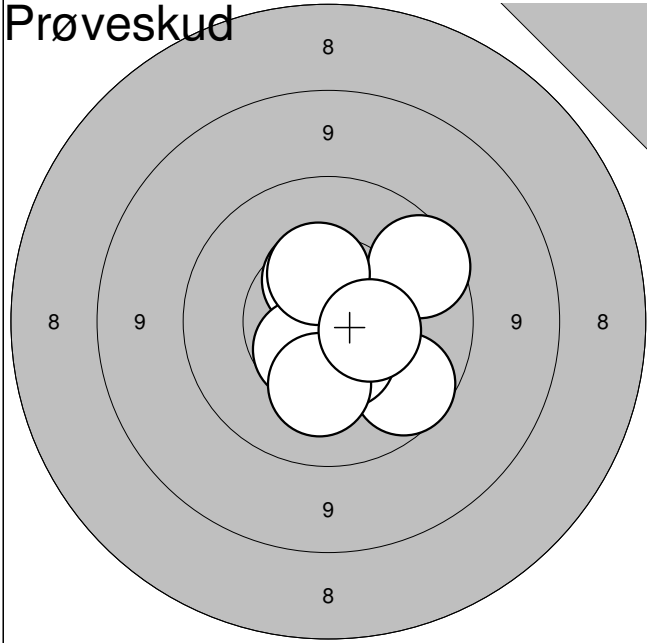

1:	9,9	↘
2:	10,7*	→
3:	10,5	↗
4:	10,5	↘
5:	9,8	↗
6:	10,6	↘
7:	10,4	↗
8:	10,3	↘
9:	10,5	→

Serie:	88,0
Sum:	0,0

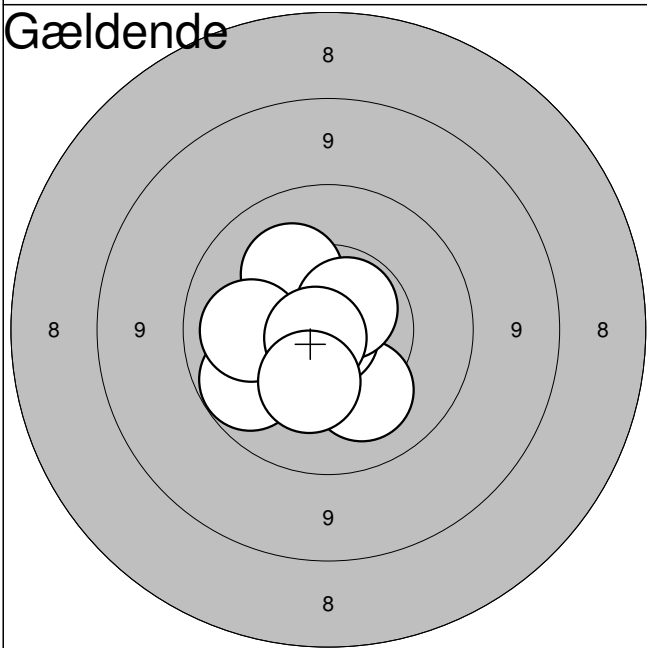

1:	10,5	↘
2:	10,2	↘
3:	10,9*	↘
4:	10,9*	←
5:	10,3	↗
6:	10,0	↙
7:	10,1	←
8:	10,7*	↗
9:	10,8*	↙
10:	10,4	↘

Serie:	100,0
Sum:	100,0

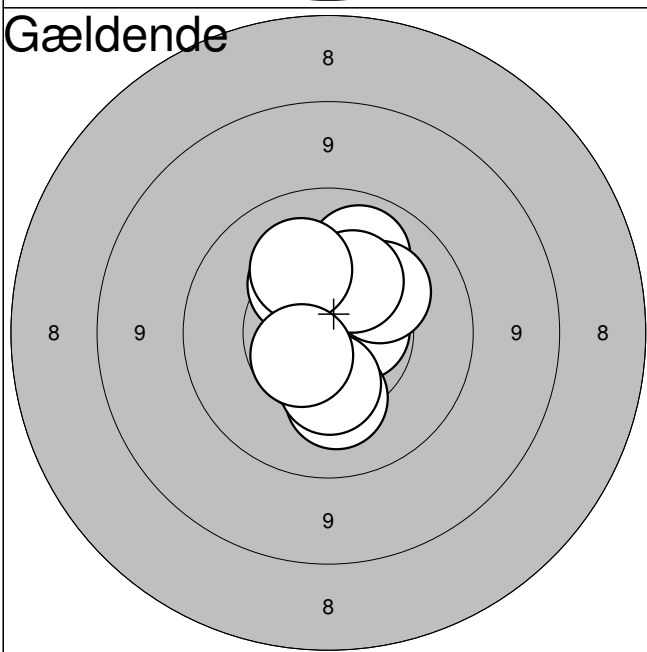

11:	10,1	↗
12:	10,4	↗
13:	10,4	↗
14:	10,6*	→
15:	10,3	↘
16:	10,3	↗
17:	10,4	↗
18:	10,2	↗
19:	10,4	↘
20:	10,6	↙

Serie:	100,0
Sum:	200,0

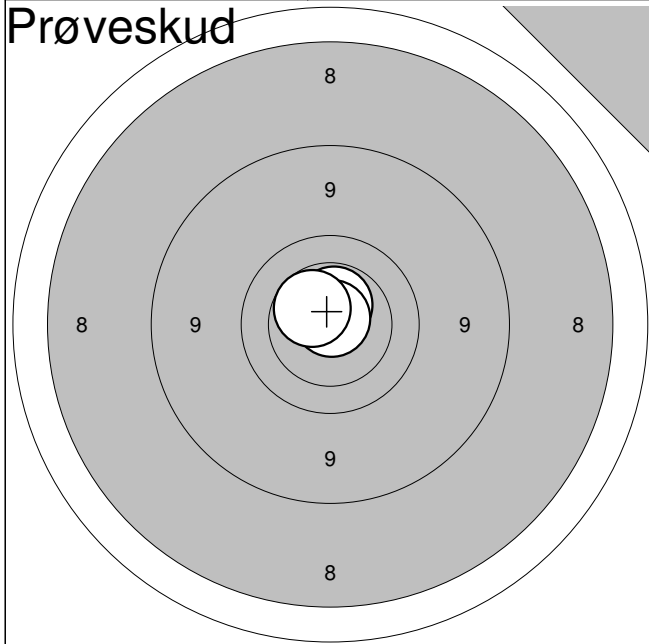

1:	10,6*	↗
2:	10,8*	↗
3:	10,5	↘
Serie:	30,0	
Sum:	0,0	

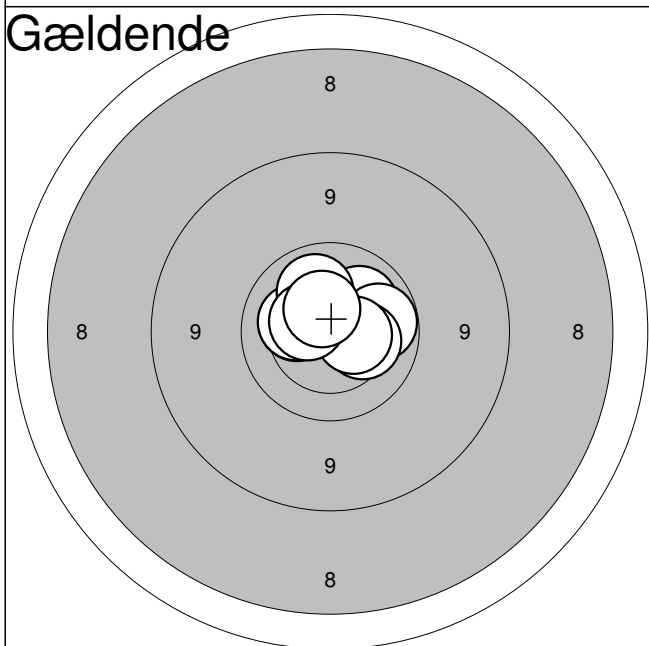

1:	10,2	↗
2:	10,0	→
3:	10,6*	↗
4:	10,3	→
5:	10,3	↖
6:	10,3	↖
7:	10,5	→
8:	10,1	↗
9:	10,5	↗
10:	10,5	↗
Serie:	100,0	
Sum:	100,0	

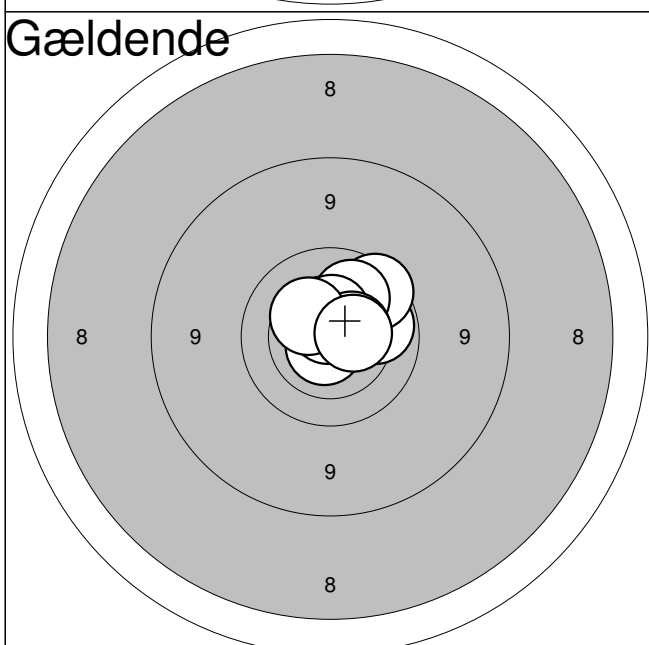

11:	10,7*	↘
12:	10,7*	↗
13:	10,0	→
14:	10,5	↗
15:	9,8	↗
16:	10,1	↗
17:	10,5*	↗
18:	10,5*	→
19:	10,4	↖
20:	10,5	→
Serie:	99,0	
Sum:	199,0	

Hold
65

Bane
2

Lise Kjær

Rostrup Skf.

ÅK3

Jyllandsstævne 2011 - riffel

Aalborg Skyttekreds

Prøveskud

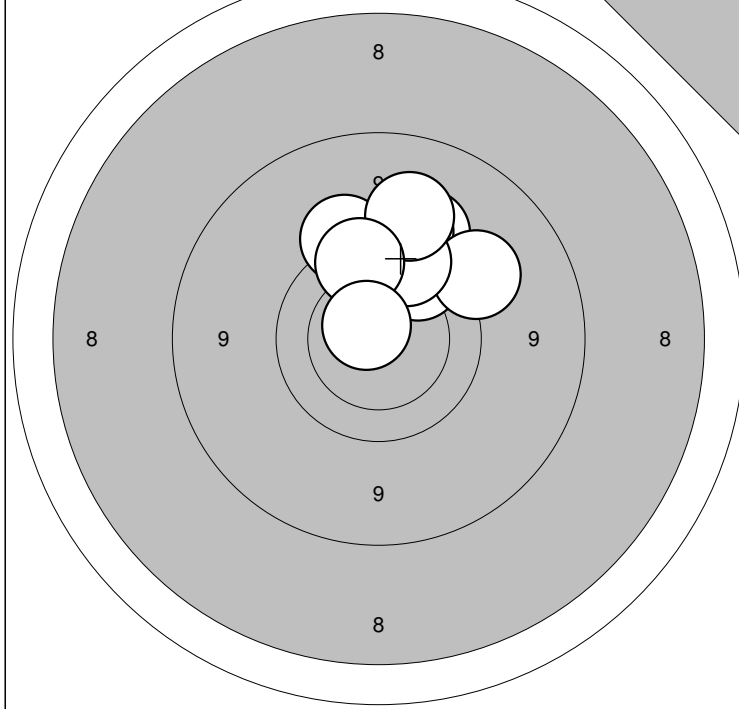

Prøveskud

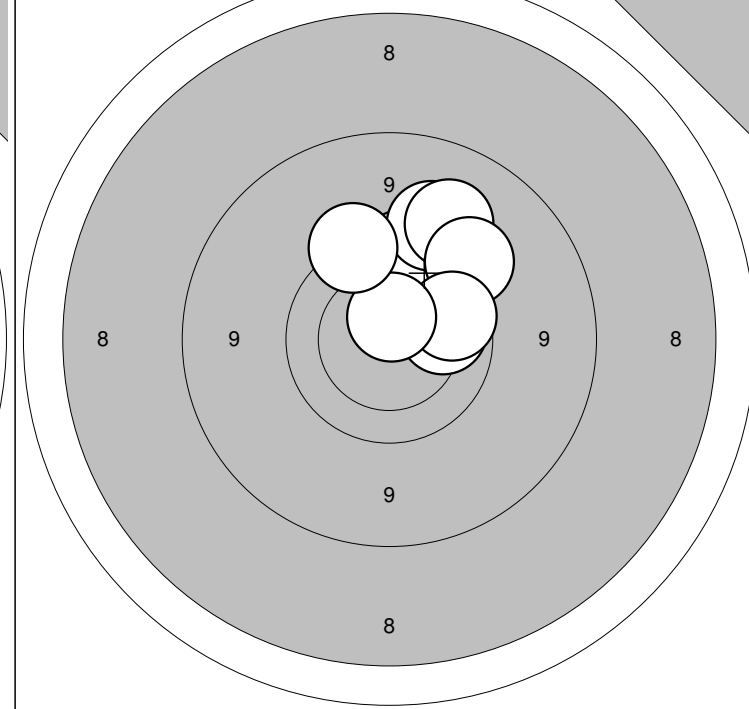

1: 9,5	↑	6: 9,4	↗	Serie: 91,0
2: 9,7	↑	7: 9,7	↑	
3: 9,8	↗	8: 9,3	↑	Sum: 0,0
4: 9,4	↗	9: 9,8	↑	
5: 9,4	↑	10:10,7*	↖	

11: 9,7	↑	16: 9,9	↗	Serie: 74,0
12: 9,4	↑	17:10,6*	↑	
13: 9,3	↑	18: 9,6	↑	Sum: 0,0
14:10,0	→			
15: 9,4	↗			

Gældende

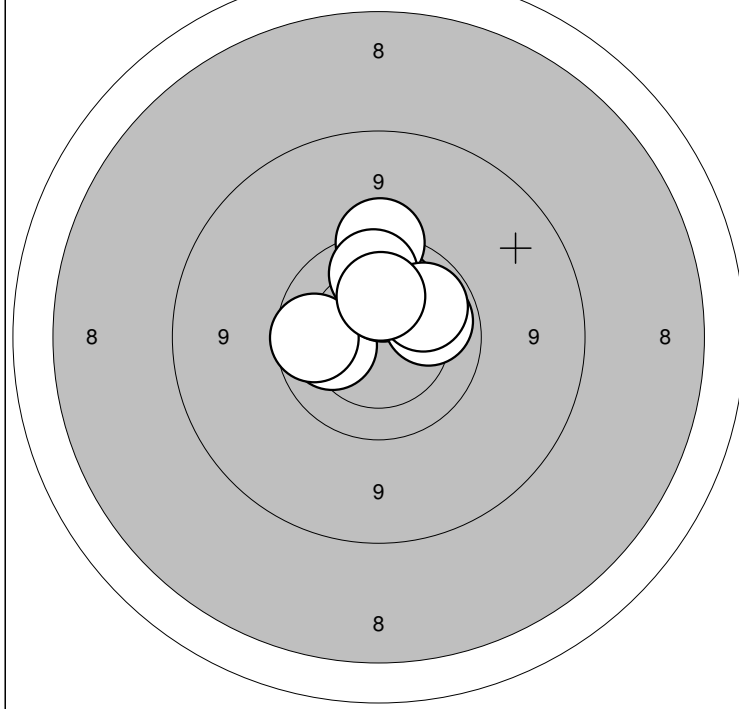

Gældende

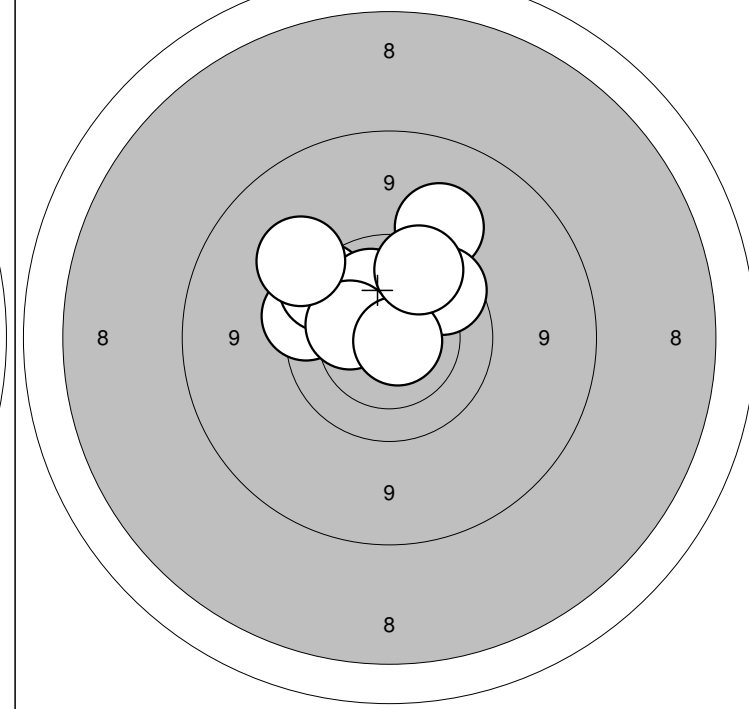

1:10,2	←	6: 0,0	↗	Serie: 87,0
2:10,2	↑	7: 9,9	←	
3:10,3	↑	8: 9,9	↑	Sum: 87,0
4: 9,6	↑	9:10,0	↗	
5:10,1	→	10:10,3	↑	

11: 9,7	←	16: 9,8	↗	Serie: 93,0
12: 9,7	↖	17:10,3	←	
13: 9,4	↑	18:10,8*	→	Sum: 180,0
14: 9,9	↑	19: 9,8	↑	
15:10,1	↑	20: 9,4	↖	

Hold
65Bane
3**Rikke Jøker**

Fræer og Omegns Skf.

ÅK3

Jyllandsstævne 2011 - riffel

Aalborg Skyttekreds

Prøveskud

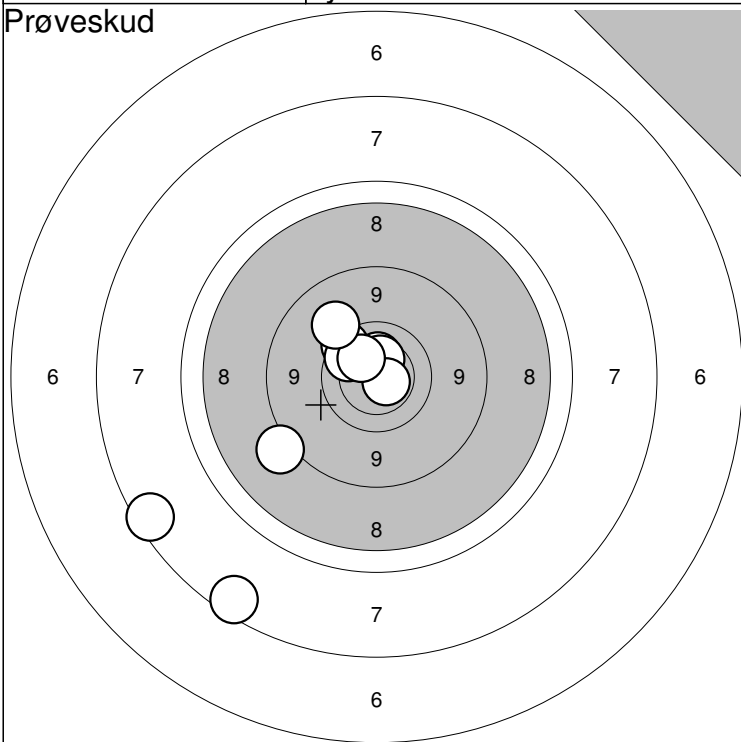

Prøveskud

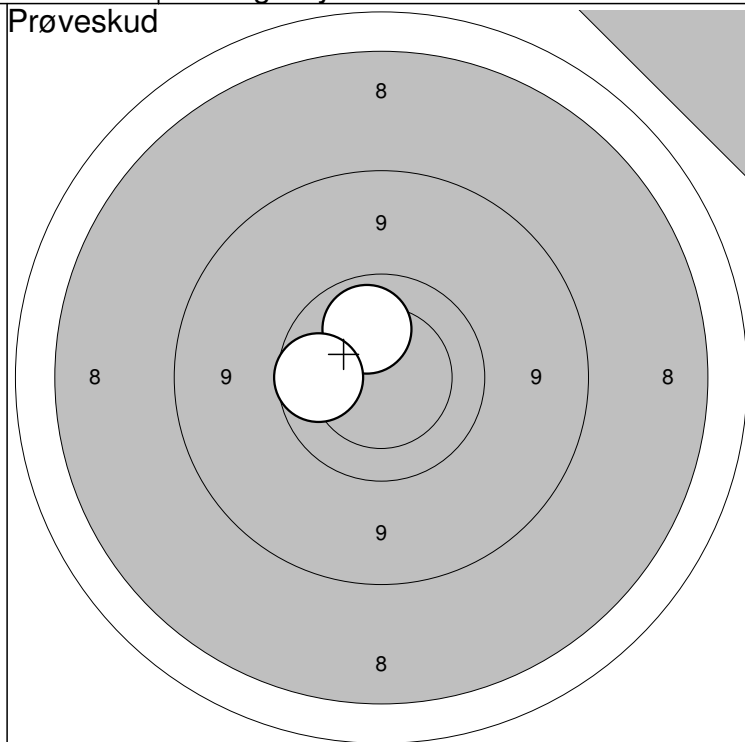

1: 6,9 ↘

2: 6,8 ↙

3: 8,6 ↙

4:10,3 ↑

5:10,4 ↑

6:10,6* ↘

7: 9,7 ↗

8: 9,9 ↗

9:10,2 ↗

10: 9,3 ↗

Serie: 87,0

Sum: 0,0

11:10,1 ↑

12: 9,9 ←

Serie: 19,0

Sum: 0,0

Gældende

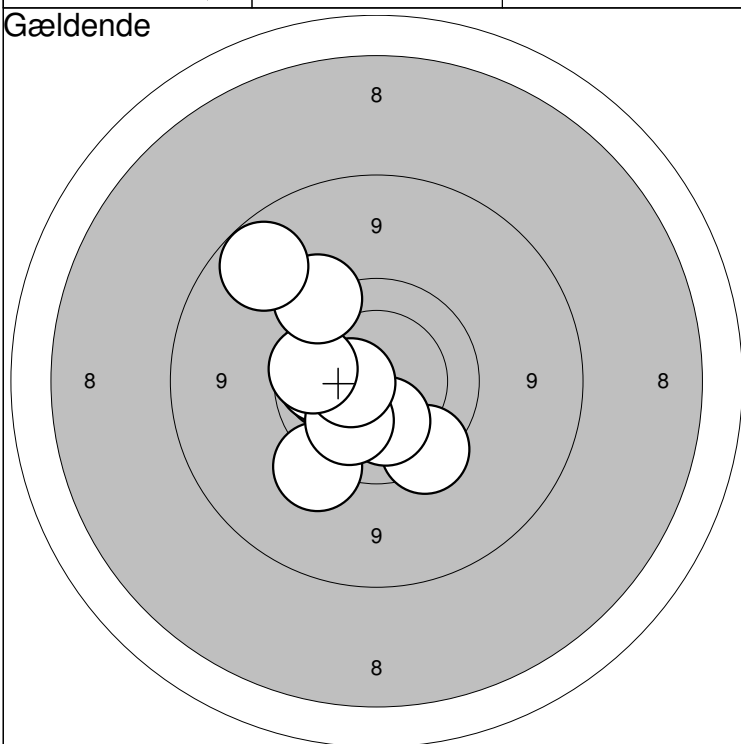

Gældende

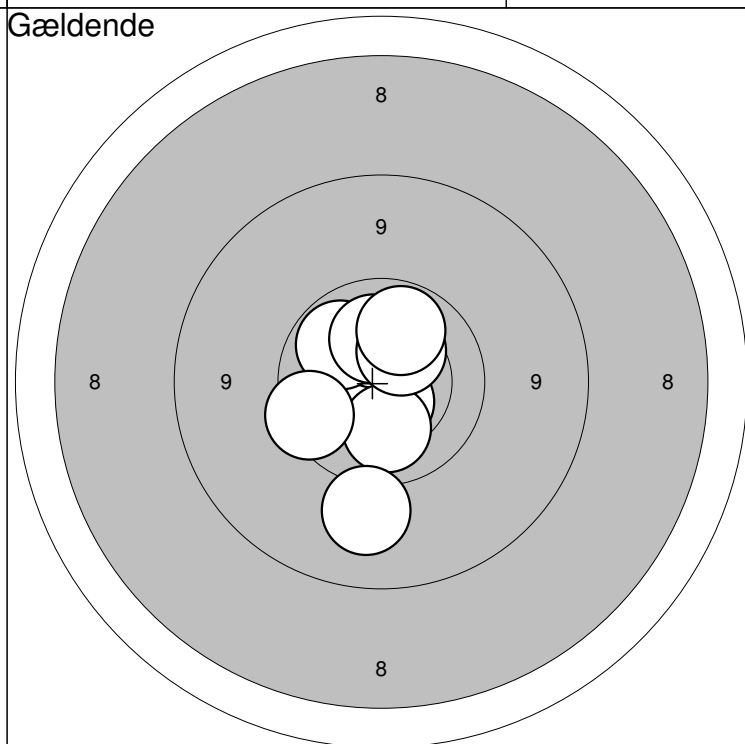

1:10,1 ←

2: 9,7 ↘

3:10,0 ←

4:10,2 ↓

5: 9,5 ↘

6:10,1 ↘

7:10,5* ←

8: 9,9 ←

9: 9,5 ↗

10: 9,0 ↗

Serie: 95,0

Sum: 95,0

11:10,6* ↘

12:10,7* ↗

13:10,3 ↑

14:10,2 ↓

15:10,0 ↗

16:10,2 ↑

17: 9,8 ←

18:10,3 ↗

19:10,0 ↑

20: 9,3 ↓

Serie: 98,0

Sum: 193,0

Jyllandsstævne 2011

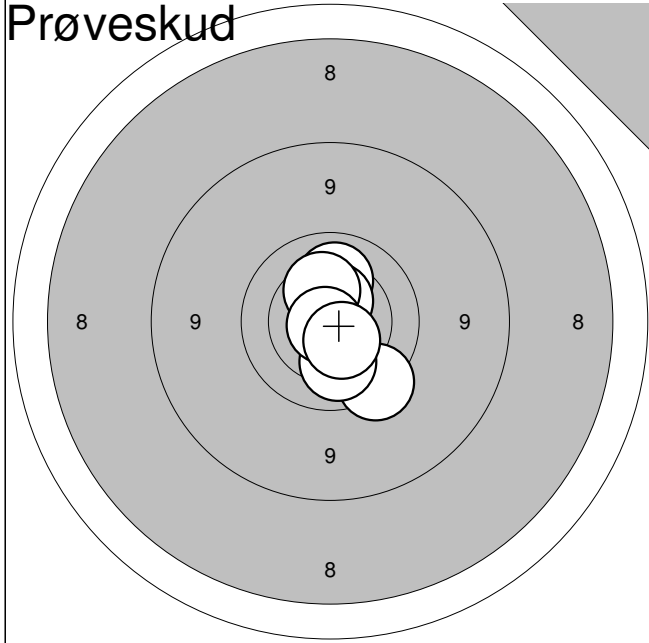

1:	10,2	↑
2:	9,7	↘
3:	10,5*	↑
4:	10,3	↑
5:	10,1	↘
6:	10,8*	↙
7:	10,5*	↘

Serie:	69,0
Sum:	0,0

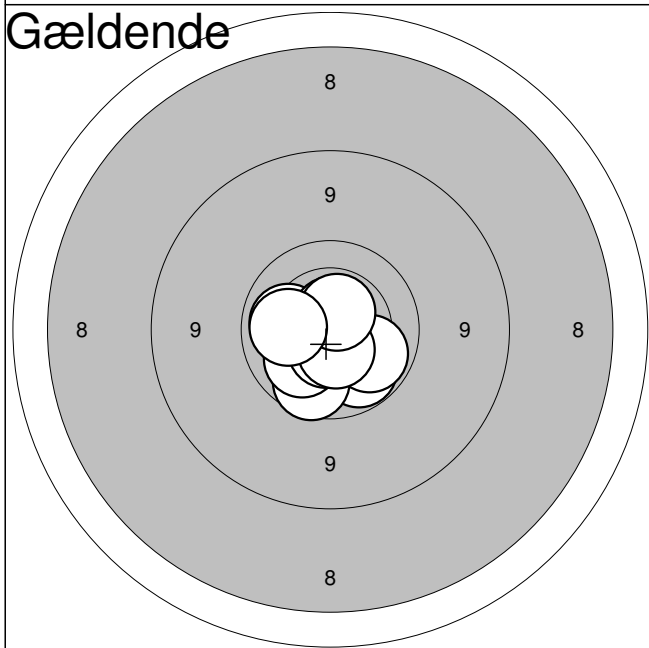

1:	10,0	↘
2:	9,9	↘
3:	10,0	↘
4:	10,2	↙
5:	10,1	←
6:	10,7*	↑
7:	10,6*	↘
8:	10,5*	↘
9:	10,6*	↑
10:	10,1	←

Serie:	99,0
Sum:	99,0

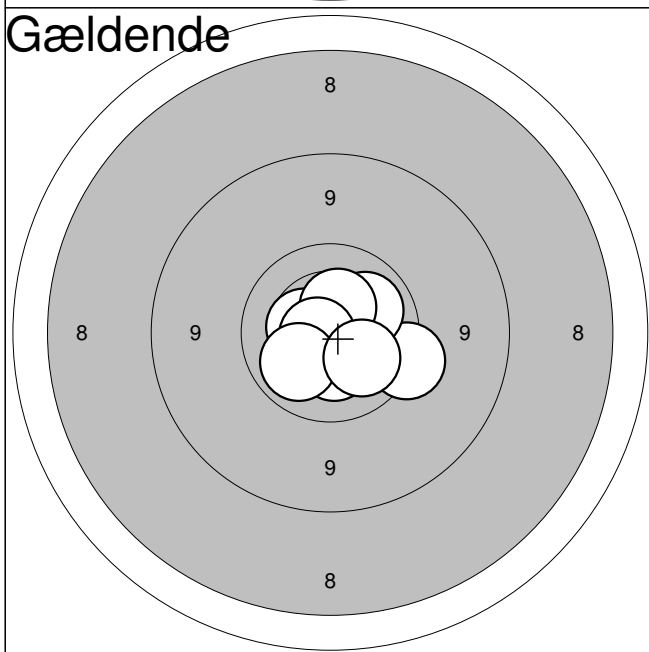

11:	9,6	→
12:	10,4	←
13:	10,6*	↗
14:	10,1	↗
15:	10,4	↑
16:	10,4	↘
17:	10,5*	↙
18:	10,7*	←
19:	10,1	↙
20:	10,2	↘

Serie:	99,0
Sum:	198,0

Hold
65Bane
5**Liam Klitgaard Walker**

Fræer og Omegns Skf.

J2

Jyllandsstævne 2011 - riffel

Aalborg Skyttekreds

Prøveskud

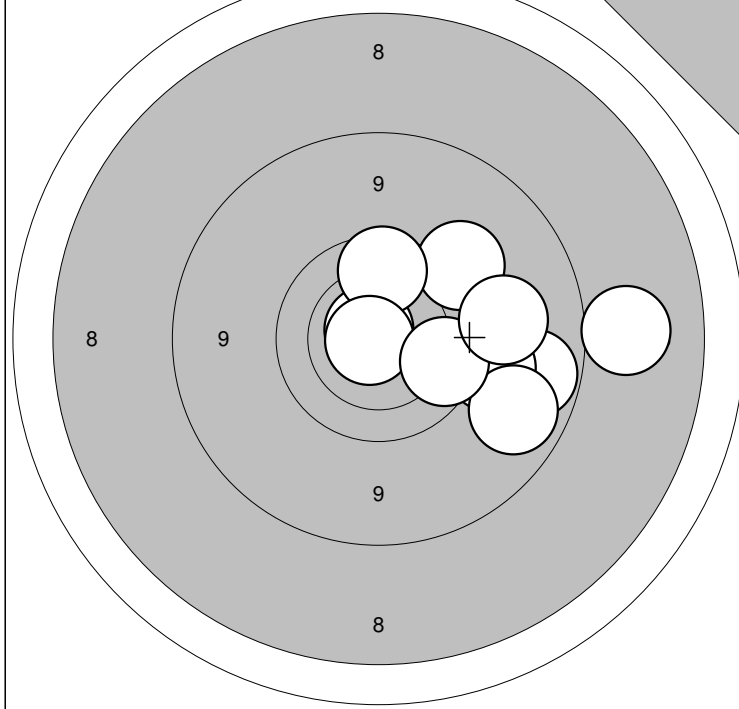

Prøveskud

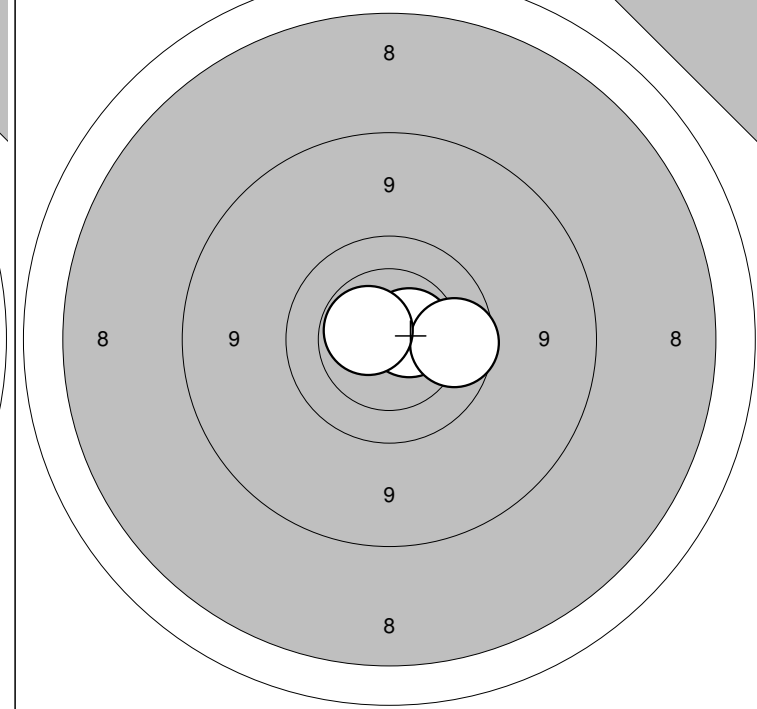

1:10,7* ↖
2: 9,0 →
3: 9,5 ↗
4: 8,4 →
5: 9,9 ↑

6:10,8* ←
7: 9,4 →
8: 9,0 ↘
9: 9,8 →
10: 9,3 →

Serie: 91,0
Sum: 0,0

11:10,6* →
12: 9,9 →
13:10,6* ←

Serie: 29,0
Sum: 0,0

Gældende

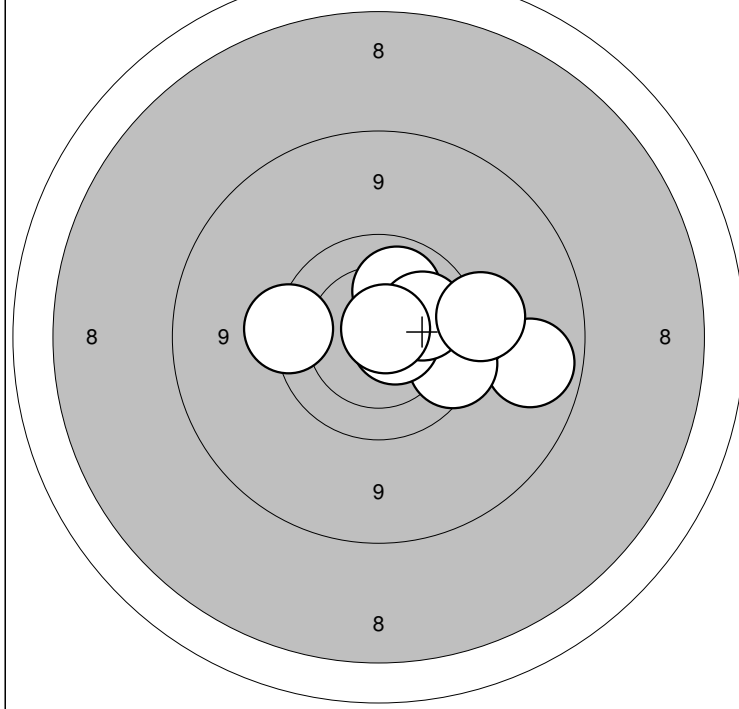

Gældende

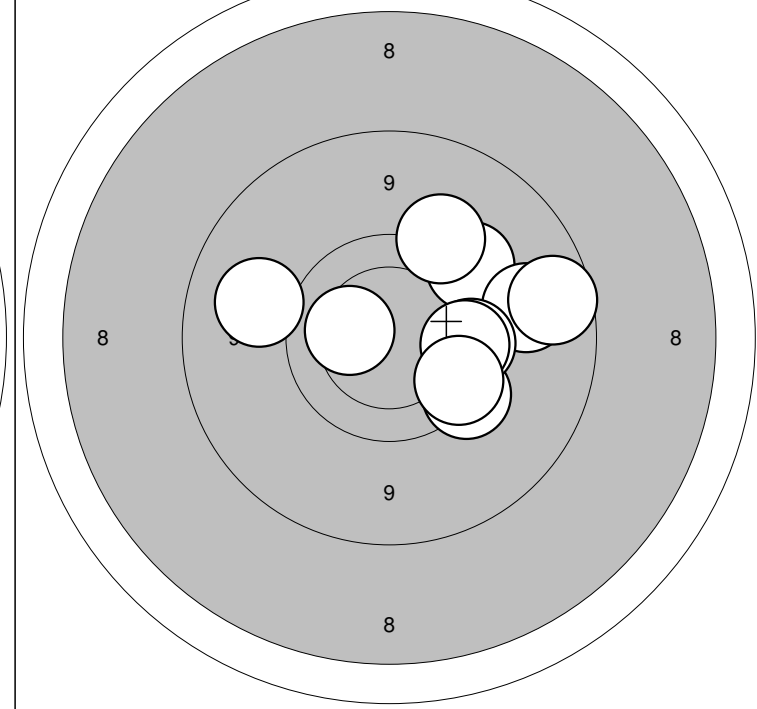

1: 9,0 →
2:10,1 ↑
3: 9,7 →
4: 9,7 ←
5:10,6* →

6: 9,8 →
7:10,7* →
8:10,1 ↗
9: 9,5 →
10:10,8* ↗

Serie: 95,0
Sum: 95,0

11: 9,5 ↗
12: 9,2 →
13: 9,6 ↘
14: 9,4 ↗
15: 9,7 →

16: 9,2 ←
17: 9,8 →
18:10,3 ←
19: 8,9 →
20: 9,7 ↘

Serie: 90,0
Sum: 185,0

Jyllandsstævne 2011

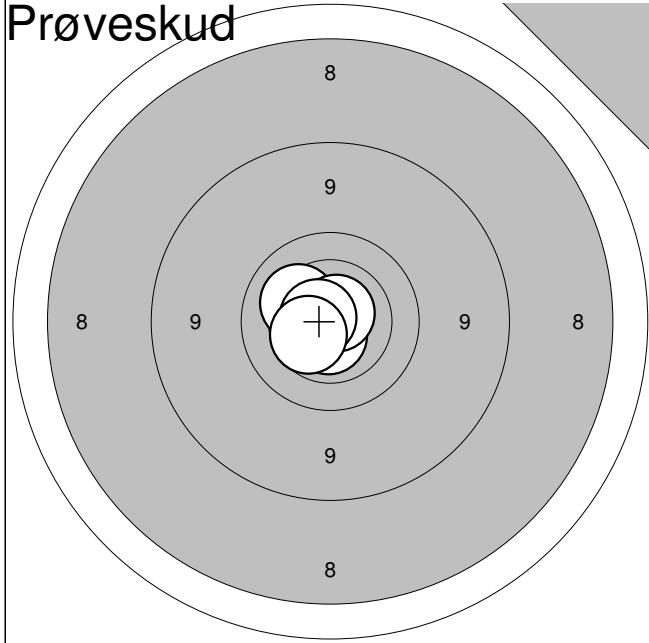

1:	10,2	↖
2:	10,7*	↓
3:	10,7*	↗
4:	10,7*	↖
5:	10,5	↙

Serie:	50,0
Sum:	0,0

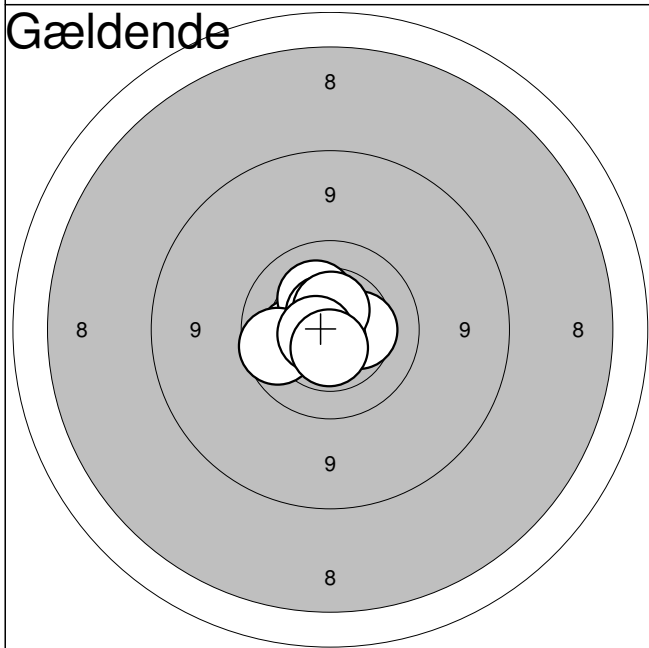

1:	10,3	←
2:	10,3	↗
3:	10,8*	↖
4:	10,4	→
5:	10,8*	↓
6:	9,9	↖
7:	10,6*	↗
8:	10,6*	↑
9:	10,7*	↖
10:	10,6*	↓

Serie:	99,0
Sum:	99,0

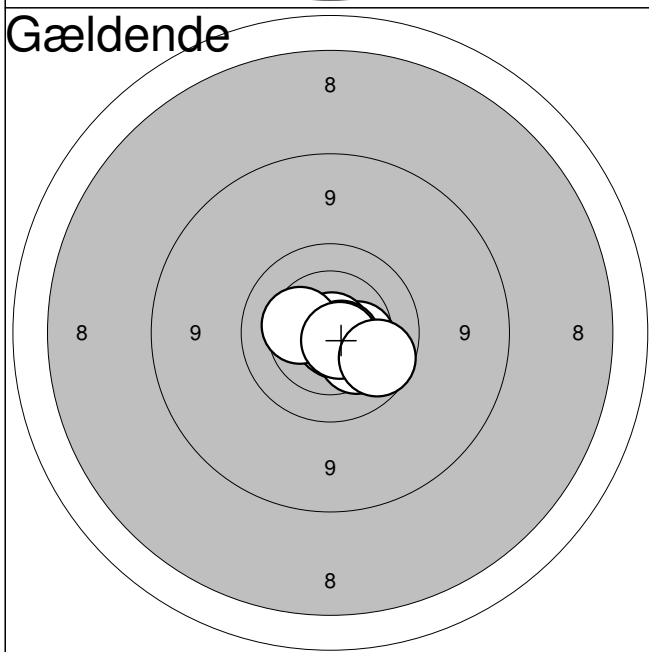

11:	10,8*	↘
12:	10,4	→
13:	10,7*	↘
14:	10,8*	↘
15:	10,3	↘
16:	10,9*	↗
17:	10,7*	↘
18:	10,3	↖
19:	10,7*	↘
20:	9,9	↘

Serie:	99,0
Sum:	198,0

Hold
65Bane
7**Karsten Stenholt**

Hobro Egnens Skytteforening

2

Jyllandsstævne 2011 - riffel

Aalborg Skyttekreds

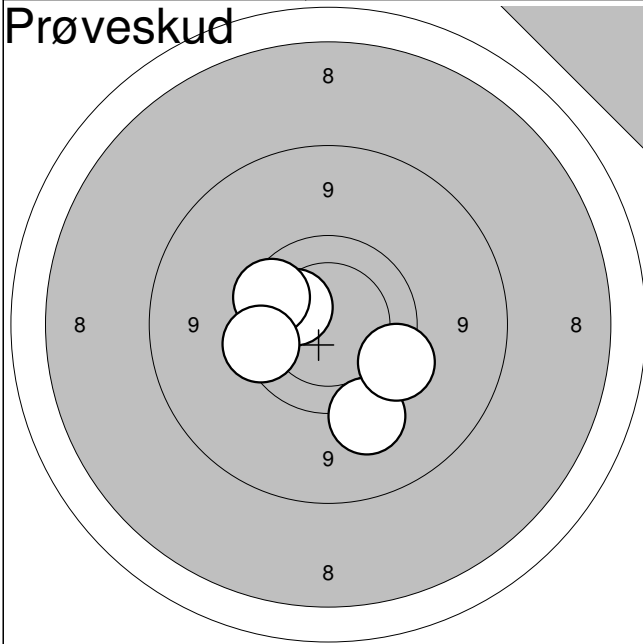
Prøveskud

1:	10,2	↖
2:	9,4	↓
3:	9,8	↗
4:	9,6	↓
5:	9,7	←

Serie: 46,0

Sum: 0,0

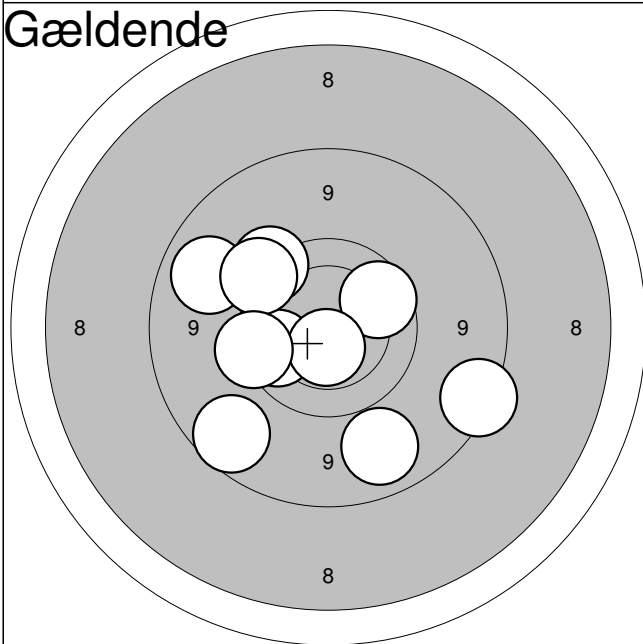
Gældende

1:	9,1	↓
2:	9,9	↗
3:	9,9	←
4:	8,9	↓
5:	9,1	↖
6:	10,6*	↓
7:	9,6	↗
8:	8,8	↘
9:	9,6	↗
10:	9,7	←

Serie: 89,0

Sum: 89,0

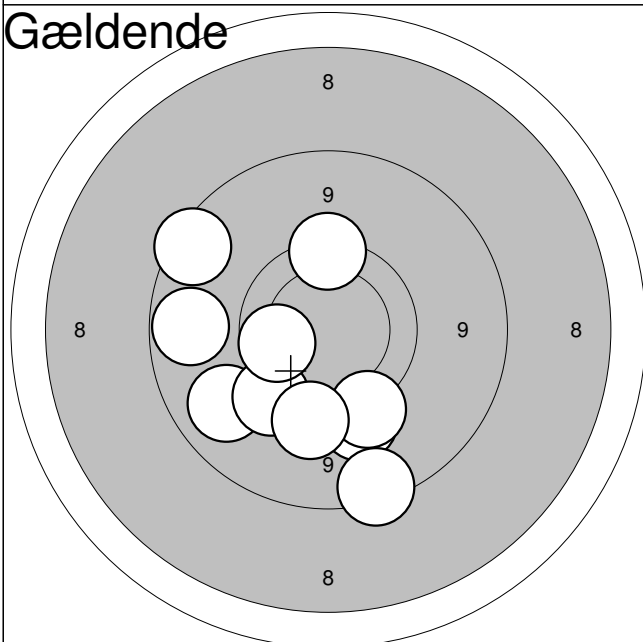
Gældende

11:	9,4	↓
12:	9,1	←
13:	9,5	↓
14:	9,5	↓
15:	9,5	↓
16:	8,8	↓
17:	8,8	↗
18:	9,6	↑
19:	9,9	←
20:	9,0	←

Serie: 88,0

Sum: 177,0

Jyllandsstævne 2011

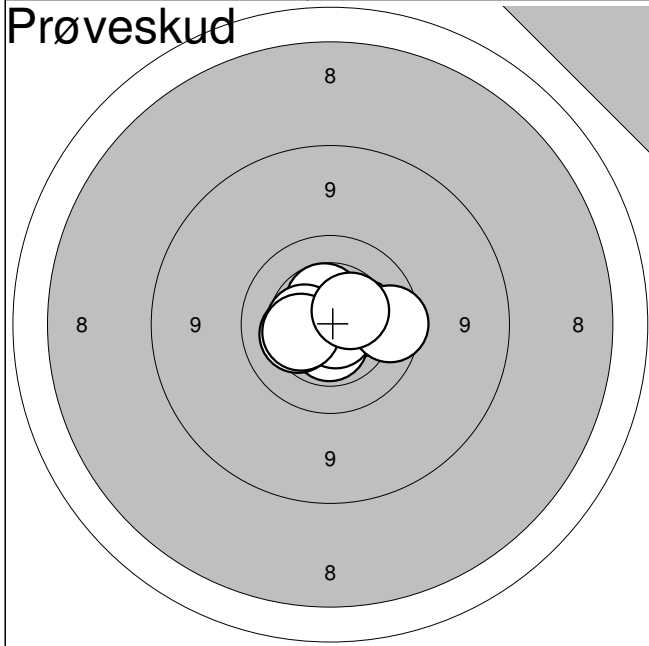

1:	10,6*	↓
2:	10,3	←
3:	10,8*	↑
4:	10,5*	↑
5:	10,3	→
6:	10,8*	↓
7:	10,5	←
8:	10,4	←
9:	9,9	→
10:	10,5	↗

Serie: 99,0

Sum: 0,0

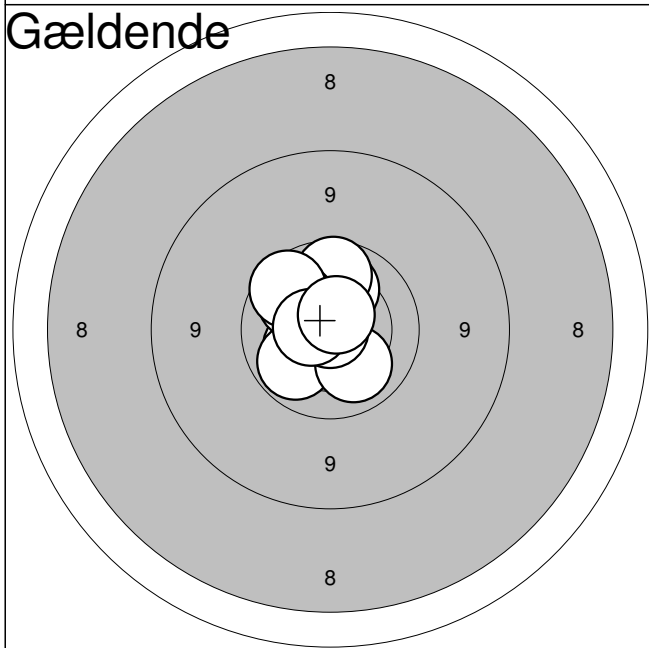

1:	10,3	↙
2:	10,1	↑
3:	10,0	↙
4:	10,1	↓
5:	9,9	↑
6:	10,9*	↓
7:	10,1	↗
8:	9,9	↗
9:	10,6*	←
10:	10,6*	↑

Serie: 98,0

Sum: 98,0

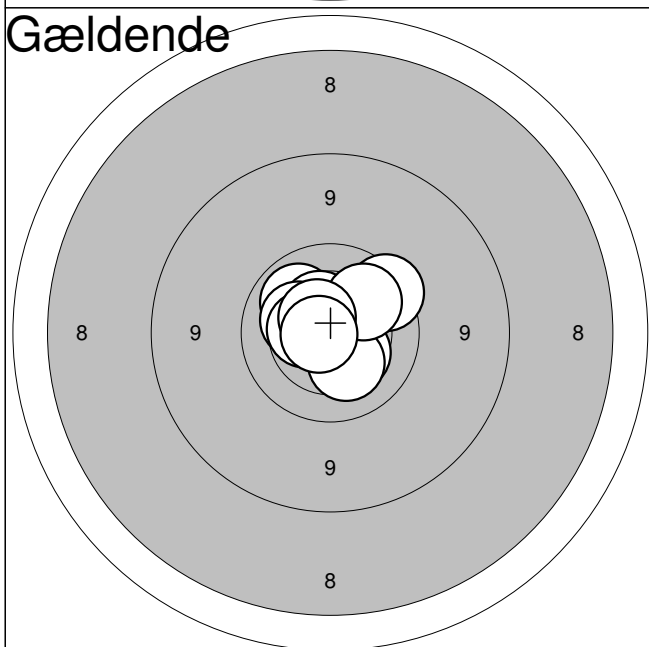

11:	10,1	↗
12:	10,4	↓
13:	9,8	↗
14:	10,5	↑
15:	10,3	↖
16:	10,3	↓
17:	10,5	←
18:	10,1	↗
19:	10,6*	↑
20:	10,7*	←

Serie: 99,0

Sum: 197,0

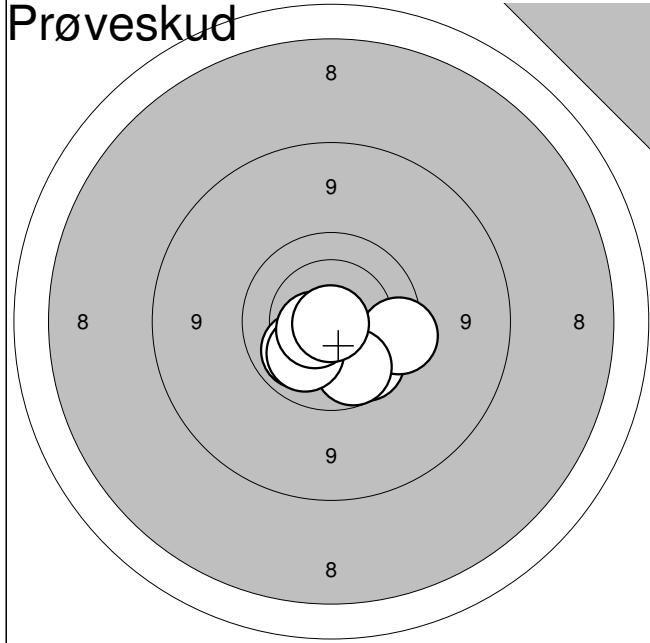

1:	10,1	↙
2:	9,9	↘
3:	9,7	→
4:	10,0	↘
5:	10,1	↘
6:	10,6*	↙
7:	10,9*	↓

Serie:	68,0
Sum:	0,0

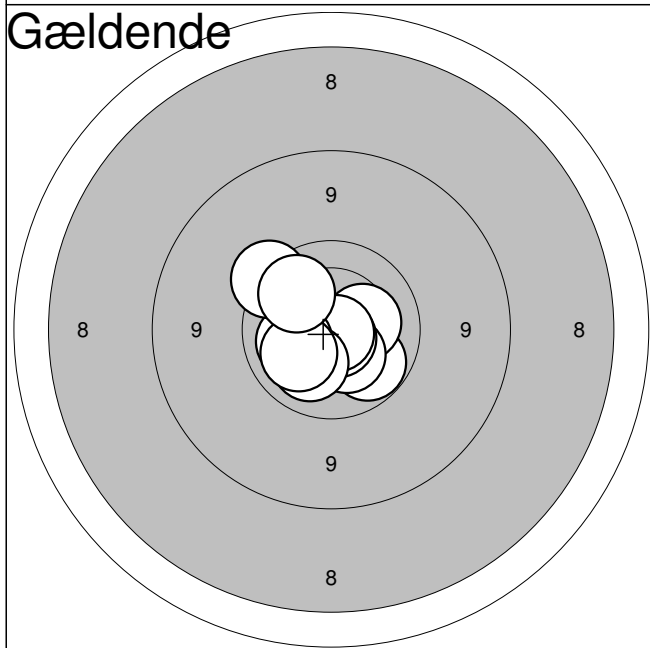

1:	10,0	↘
2:	10,3	→
3:	10,4	↘
4:	10,7*	↘
5:	10,8*	↘
6:	10,2	↙
7:	10,2	↘
8:	9,6	↗
9:	10,2	↙
10:	10,0	↗

Serie:	99,0
Sum:	99,0

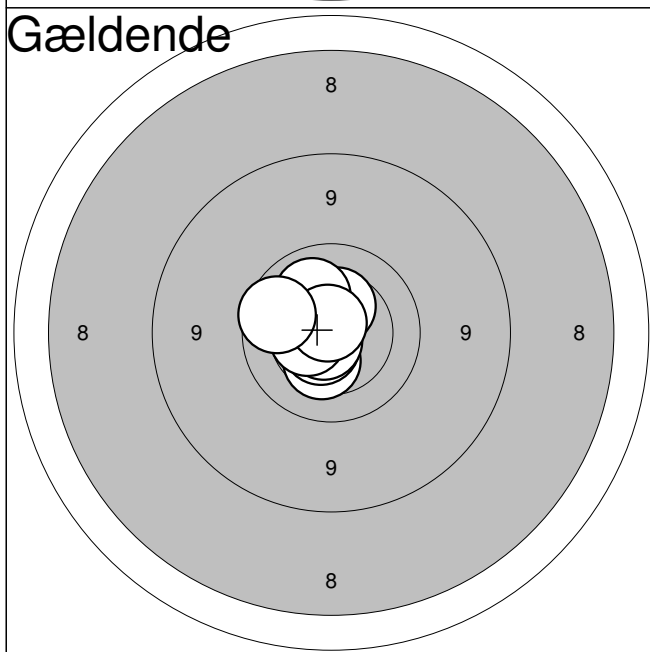

11:	10,6*	↙
12:	10,4	↘
13:	10,8*	↙
14:	10,6*	↘
15:	10,4	↗
16:	10,7*	↘
17:	10,5	↙
18:	10,2	↗
19:	10,8*	↗
20:	9,9	↙

Serie:	99,0
Sum:	198,0

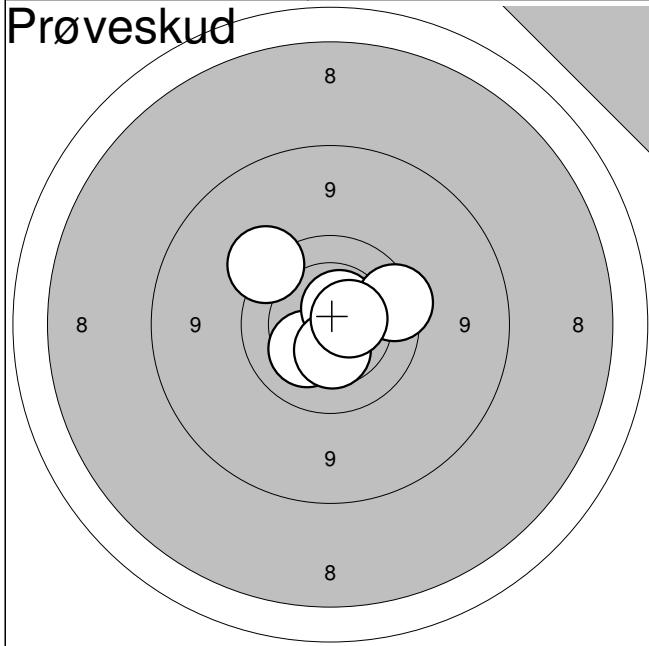

1:	10,3	↘
2:	10,6*	↗
3:	9,8	→
4:	9,6	↗
5:	10,4	↘
6:	10,6*	→

Serie:	58,0
Sum:	0,0

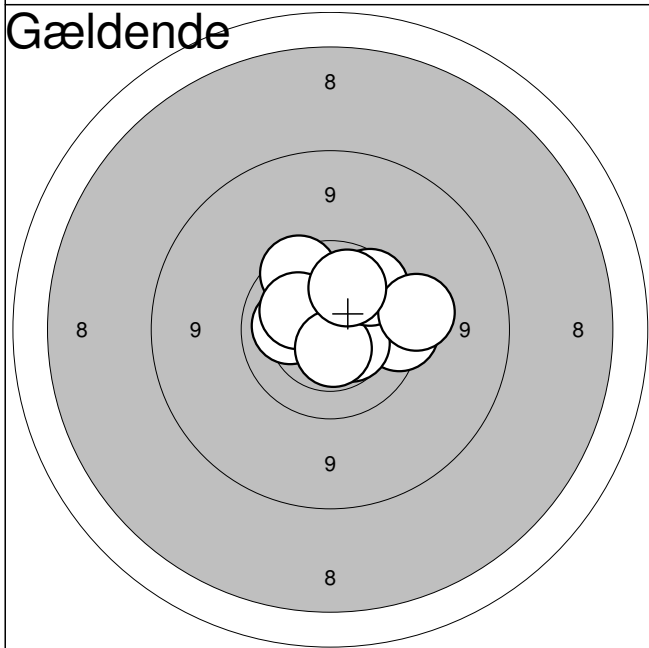

1:	10,2	←
2:	10,0	→
3:	9,7	→
4:	9,8	↗
5:	10,2	↗
6:	10,5	↘
7:	10,6*	↘
8:	9,9	↗
9:	9,5	→
10:	10,1	↗

Serie:	96,0
Sum:	96,0

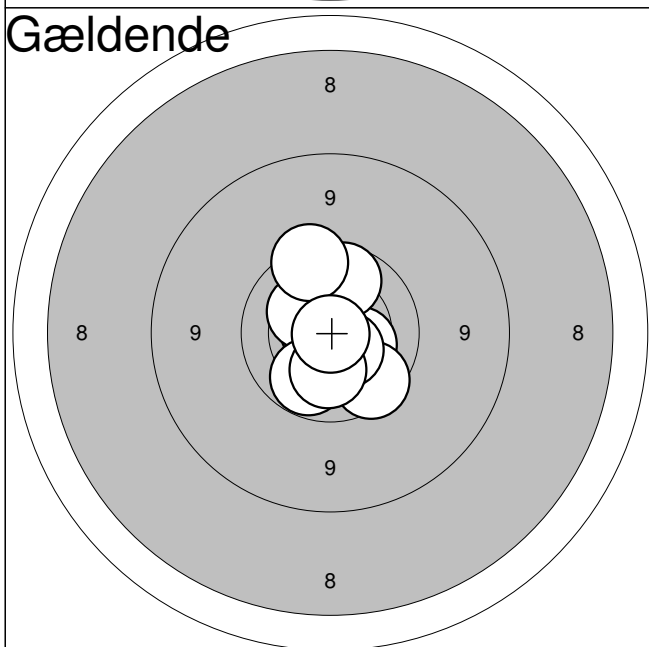

11:	10,7*	←
12:	10,3	↘
13:	9,8	↘
14:	10,3	↗
15:	10,0	↘
16:	9,9	↗
17:	9,7	↗
18:	10,5*	↘
19:	10,2	↘
20:	10,9*	↘

Serie:	97,0
Sum:	193,0

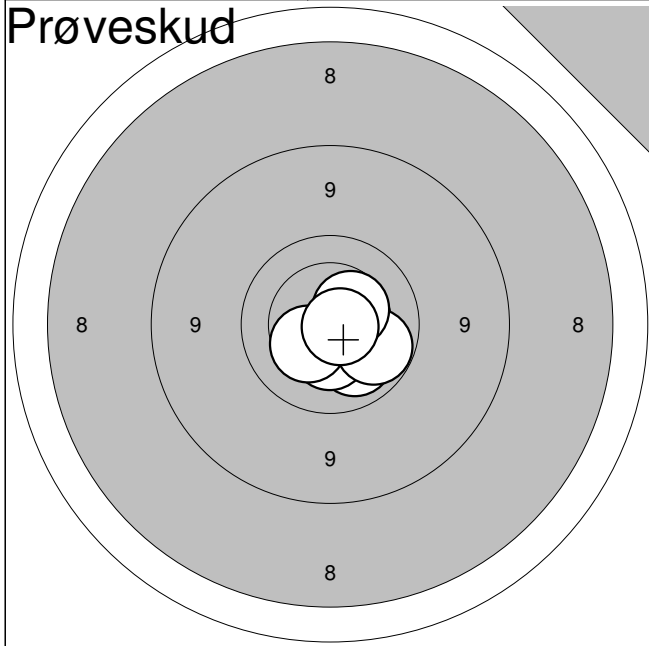

1:	10,1	↘
2:	10,4	↓
3:	10,0	→
4:	10,5	↗
5:	10,4	↙
6:	10,7*	→

Serie:	60,0
Sum:	0,0

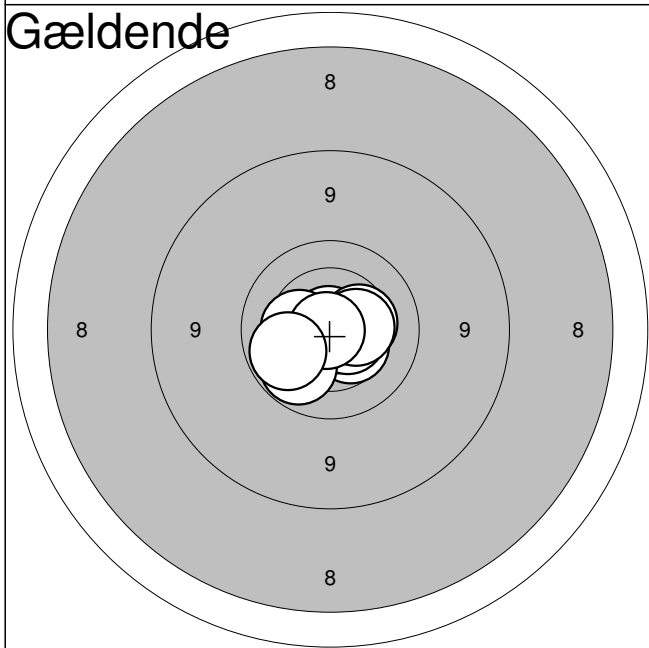

1:	10,4	↘
2:	10,9*	↑
3:	10,4	→
4:	10,8*	↘
5:	10,4	←
6:	10,6*	↗
7:	10,4	→
8:	10,0	↙
9:	10,9*	←
10:	10,0	↙

Serie:	100,0
Sum:	100,0

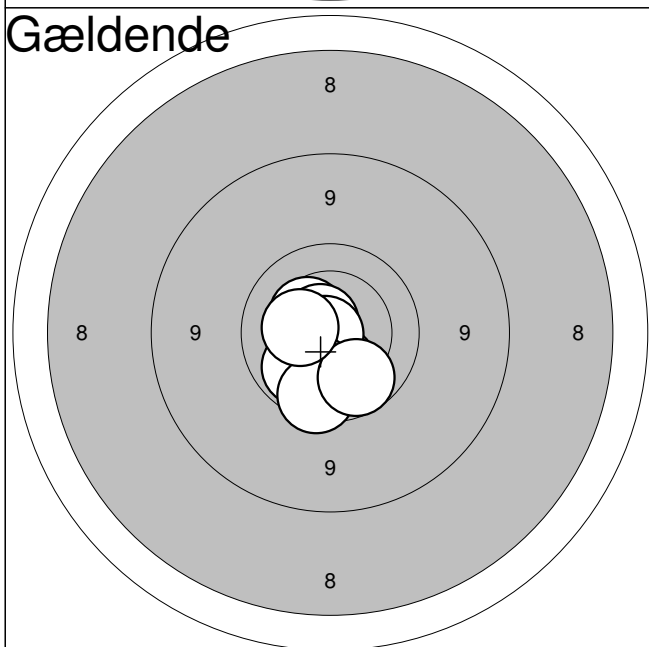

11:	10,7*	↙
12:	10,4	↗
13:	10,7*	↗
14:	10,3	↘
15:	10,9*	←
16:	10,1	↘
17:	10,1	↙
18:	9,8	↘
19:	9,9	↘
20:	10,4	←

Serie:	98,0
Sum:	198,0